



Triangulation sensor (BGS)

OBT350-R101-2EP-IO



- Miniature design with versatile mounting options
- Best background suppressor in its class
- Precision object detection, almost irrespective of the color
- Extended temperature range
-40 °C ... 60 °C
- High degree of protection IP69K
- IO-Link interface for service and process data

Triangulation sensor with background suppression



IO-Link

Function

The miniature optical sensors are the first devices of their kind to offer an end-to-end solution in a small single standard design — from thru-beam sensor through to a distance measurement device. As a result of this design, the sensors are able to perform practically all standard automation tasks.

The DuraBeam laser sensors are durable and can be used in the same way as a standard sensor.

The use of Multi Pixel Technology gives the standard sensors a high level of flexibility and enables them to adapt more effectively to their operating environment.

Dimensions

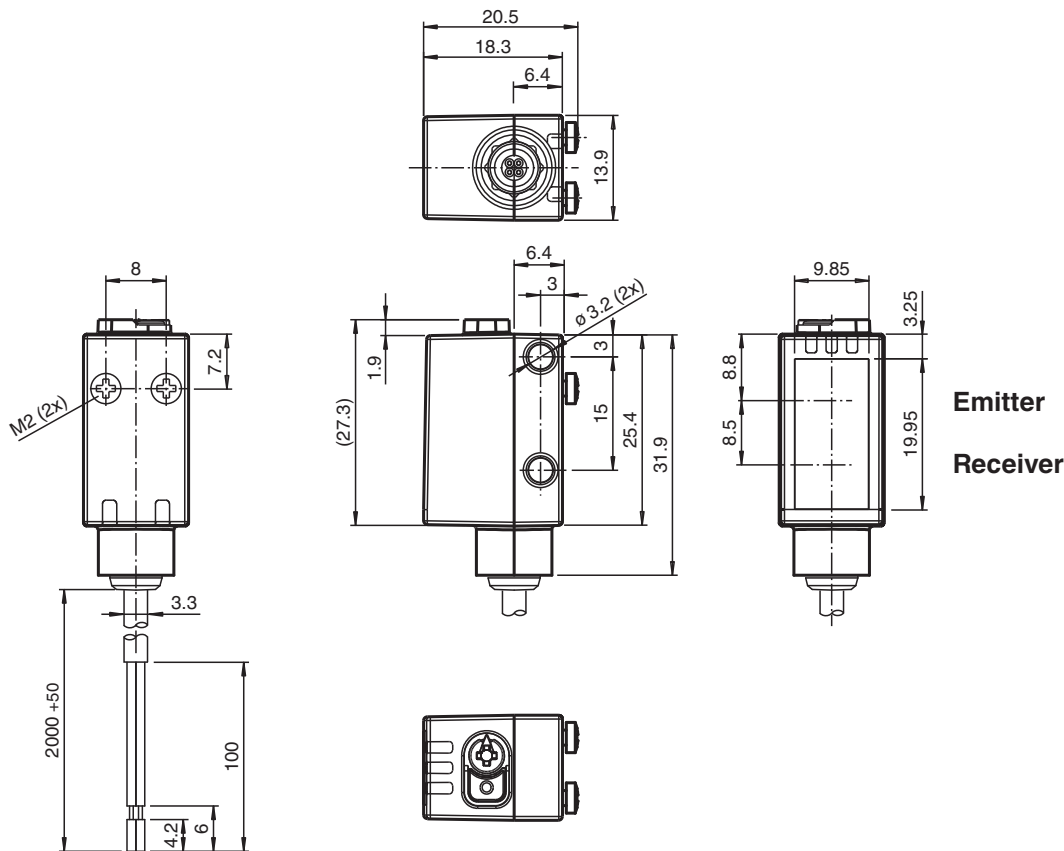

Emitter
Receiver

Release date: 2023-04-05 Date of issue: 2023-04-05 Filename: 267075-0094_eng.pdf

Technical Data

General specifications		
Detection range		5 ... 350 mm
Detection range min.		5 ... 25 mm
Detection range max.		5 ... 350 mm
Adjustment range		25 ... 350 mm
Reference target		standard white, 100 mm x 100 mm
Light source		LED
Light type		modulated visible red light
LED risk group labelling		exempt group
Black-white difference (6%/90%)		< 15 % at 350 mm
Diameter of the light spot		approx. 20 mm at a distance of 350 mm
Opening angle		approx. 3 °
Ambient light limit		EN 60947-5-2 : 40000 Lux
Functional safety related parameters		
MTTF _d		600 a
Mission Time (T _M)		20 a
Diagnostic Coverage (DC)		0 %
Indicators/operating means		
Operation indicator		LED green: constantly on - power on flashing (4Hz) - short circuit flashing with short break (1 Hz) - IO-Link mode
Function indicator		LED yellow: constantly on - object detected constantly off - object not detected
Control elements		Light-on/dark-on changeover switch
Control elements		Sensing range adjuster
Electrical specifications		
Operating voltage	U _B	10 ... 30 V DC
Ripple		max. 10 %
No-load supply current	I ₀	< 25 mA at 24 V supply voltage
Protection class		III
Interface		
Interface type		IO-Link (via C/Q = BK)
IO-Link revision		1.1
Device profile		Smart Sensor
Device ID		0x110601 (1115649)
Transfer rate		COM2 (38.4 kBit/s)
Min. cycle time		2.3 ms
Process data width		Process data input 1 Bit Process data output 2 Bit
SIO mode support		yes
Compatible master port type		A
Output		
Switching type		The switching type of the sensor is adjustable. The default setting is: C/Q - BK: NPN normally open / light-on, PNP normally closed / dark-on, IO-Link /Q - WH: NPN normally closed / dark-on, PNP normally open / light-on
Signal output		2 push-pull (4 in 1) outputs, short-circuit protected, reverse polarity protected, overvoltage protected
Switching voltage		max. 30 V DC
Switching current		max. 100 mA , resistive load
Usage category		DC-12 and DC-13
Voltage drop	U _d	≤ 1.5 V DC
Switching frequency	f	500 Hz
Response time		1 ms
Conformity		

Technical Data

Communication interface	IEC 61131-9
Product standard	EN 60947-5-2
Approvals and certificates	
UL approval	E87056 , cULus Listed , class 2 power supply , type rating 1
Ambient conditions	
Ambient temperature	-40 ... 60 °C (-40 ... 140 °F) , fixed cable -25 ... 60 °C (-13 ... 140 °F) , movable cable not appropriate for conveyor chains
Storage temperature	-40 ... 70 °C (-40 ... 158 °F)
Mechanical specifications	
Housing width	13.9 mm
Housing height	33.8 mm
Housing depth	18.3 mm
Degree of protection	IP67 / IP69 / IP69K
Connection	2 m fixed cable
Material	
Housing	PC (Polycarbonate)
Optical face	PMMA
Mass	approx. 36 g
Cable length	2 m

Connection

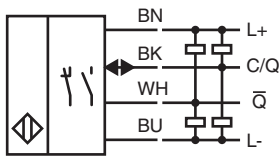

Assembly

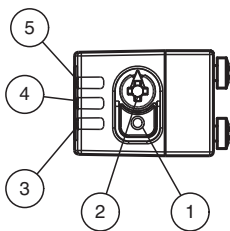

1	Light-on/dark-on changeover switch
2	Sensing range adjuster
3	Operating indicator / dark on
4	Signal indicator
5	Operating indicator / light on

Characteristic Curve

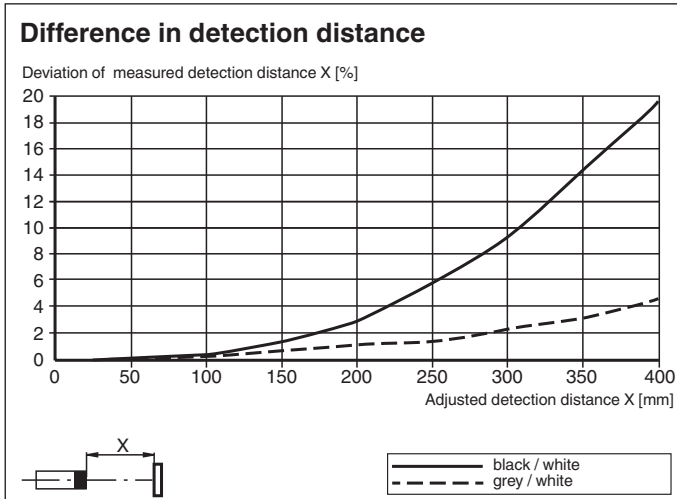
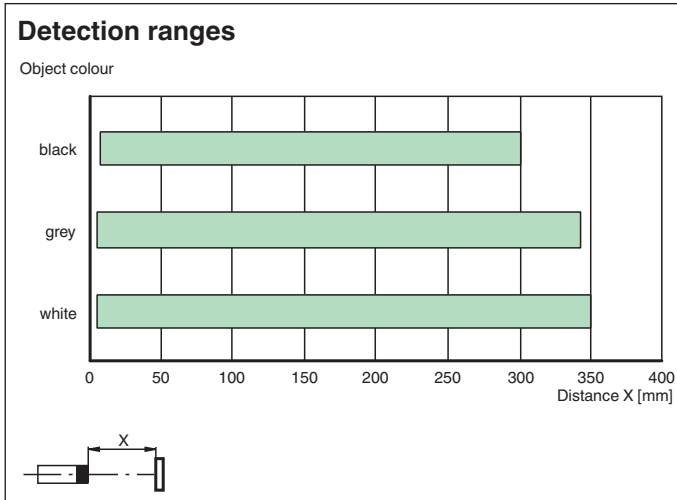
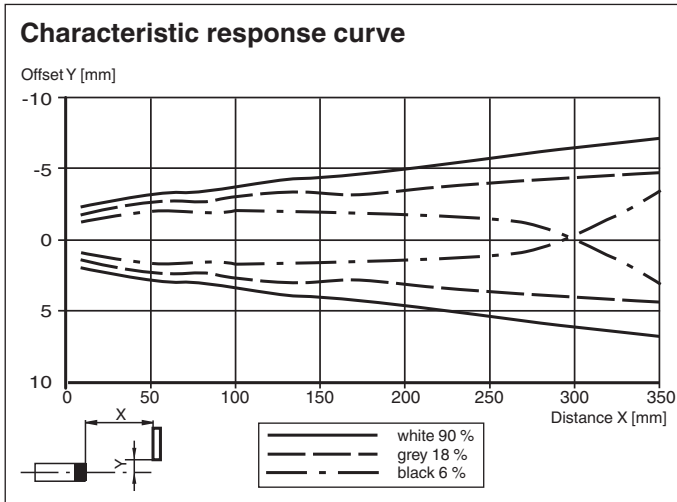







Accessories

	ICE2-8IOL-G65L-V1D	EtherNet/IP IO-Link master with 8 inputs/outputs
	ICE3-8IOL-G65L-V1D	PROFINET IO IO-Link master with 8 inputs/outputs
	ICE1-8IOL-G30L-V1D	Ethernet IO-Link module with 8 inputs/outputs

Release date: 2023-04-05 Date of issue: 2023-04-05 Filename: 267075-0094_eng.pdf

Accessories

	ICE1-8IOL-G60L-V1D	Ethernet IO-Link module with 8 inputs/outputs
	ICE2-8IOL-K45P-RJ45	EtherNet/IP IO-Link master with 8 inputs/outputs, DIN rail, push-in connectors
	ICE2-8IOL-K45S-RJ45	EtherNet/IP IO-Link master with 8 inputs/outputs, DIN rail, screw terminal
	ICE3-8IOL-K45P-RJ45	PROFINET IO IO-Link master with 8 inputs/outputs, DIN rail, push-in terminals
	ICE3-8IOL-K45S-RJ45	PROFINET IO IO-Link master with 8 inputs/outputs, DIN rail, screw terminal
	IO-Link-Master02-USB	IO-Link master, supply via USB port or separate power supply, LED indicators, M12 plug for sensor connection

Configuration

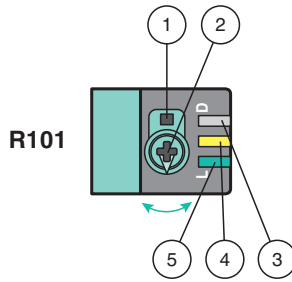

- 1 - Light on / dark on changeover switch
- 2 - Sensing range / sensitivity adjuster
- 3 - Operating indicator / dark on
- 4 - Signal indicator
- 5 - Operating indicator / light on

To unlock the adjustment functions turn the sensing range adjuster for more than 180 degrees.

Sensing Range / Sensitivity

Turn sensing range / sensitivity adjuster clockwise to increase sensing range / sensitivity.

Turn sensing range /sensitivity adjuster counterclockwise to decrease sensing range / sensitivity.

If the end of the adjustment range is reached, the signal indicator starts flashing with 8 Hz.

Light on / Dark on Configuration

Press the light on / dark on changeover switch for more than 1 second (less than 4 seconds). The light on / dark on mode changes and the operating indicators are activated accordingly.

If you press the light on / dark on changeover switch for more than 4 seconds, the light on / dark on mode changes back to the original setting. On release of the light on / dark on changeover switch the current state is activated.

Restore Factory Settings

Press the light on / dark on changeover switch for more than 10 seconds (less than 30 seconds) until all LEDs turn off. On release of the light on / dark on changeover switch the signal indicator turns on. After 5 seconds the sensor resumes operation with factory settings.

After 5 minutes of inactivity the sensing range / sensitivity adjustment is locked. In order to reactivate the sensing range / sensitivity adjustment, turn the sensing range / sensitivity adjuster for more than 180 degrees.