



# Triangulation sensor (BGE)

## OBT300-R101-2EP-IO-1T-L-Y0113



- Miniature design with versatile mounting options
- Secure and gapless detection, even near the surface through background evaluation
- DuraBeam Laser Sensors - durable and employable like an LED
- Extended temperature range  
-40 °C ... 60 °C
- High degree of protection IP69K
- IO-Link interface for service and process data

Laser diffuse mode sensor with background evaluation



### Function

The miniature optical sensors are the first devices of their kind to offer an end-to-end solution in a small single standard design — from thru-beam sensor through to a distance measurement device. As a result of this design, the sensors are able to perform practically all standard automation tasks.

The DuraBeam laser sensors are durable and can be used in the same way as a standard sensor.

The use of Multi Pixel Technology gives the standard sensors a high level of flexibility and enables them to adapt more effectively to their operating environment.

### Dimensions

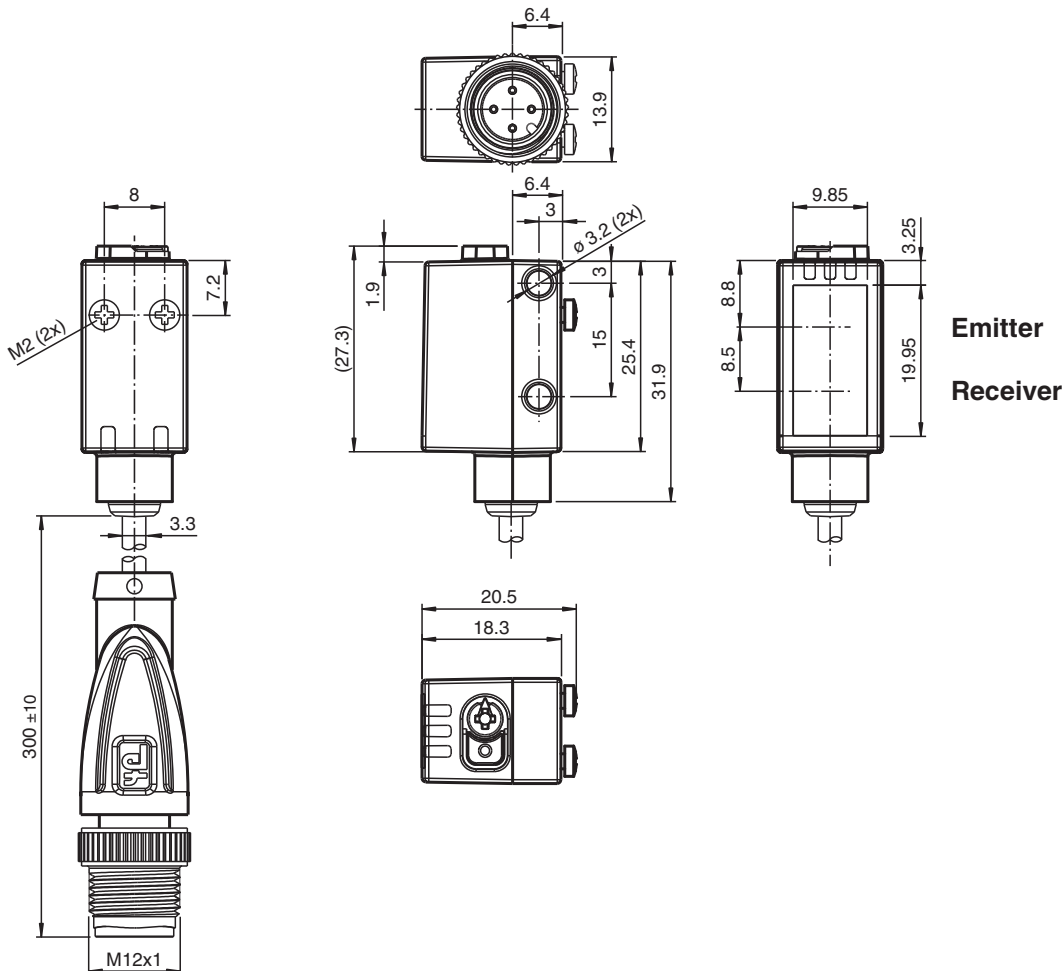

Release date: 2023-04-05 Date of issue: 2023-04-05 Filename: 267075-0113\_eng.pdf

## Technical Data

General specifications	
Detection range	7 ... 300 mm
Detection range min.	7 ... 25 mm
Detection range max.	7 ... 300 mm
Adjustment range	25 ... 300 mm
Reference target	standard white, 100 mm x 100 mm
Light source	laser diode
Light type	modulated visible red light
Laser nominal ratings	
Note	LASER LIGHT , DO NOT STARE INTO BEAM
Laser class	1
Wave length	680 nm
Beam divergence	> 5 mrad d63 < 1 mm in the range of 150 mm ... 250 mm
Pulse length	3 $\mu$ s
Repetition rate	approx. 13 kHz
max. pulse energy	10.4 nJ
Black-white difference (6 %/90 %)	< 5 % at 150 mm
Diameter of the light spot	approx. 1 mm at a distance of 200 mm
Opening angle	approx. 0.3 °
Ambient light limit	EN 60947-5-2 : 40000 Lux
Functional safety related parameters	
MTTF <sub>d</sub>	560 a
Mission Time (T <sub>M</sub> )	20 a
Diagnostic Coverage (DC)	0 %
Indicators/operating means	
Operation indicator	LED green: constantly on - power on flashing (4Hz) - short circuit flashing with short break (1 Hz) - IO-Link mode
Function indicator	LED yellow: constantly on - background detected (object not detected) constantly off - object detected
Control elements	Light-on/dark-on changeover switch
Control elements	Sensing range adjuster
Electrical specifications	
Operating voltage	U <sub>B</sub> 10 ... 30 V DC
Ripple	max. 10 %
No-load supply current	I <sub>0</sub> < 20 mA at 24 V supply voltage
Protection class	III
Interface	
Interface type	IO-Link ( via C/Q = pin 4 )
IO-Link revision	1.1
Device profile	Smart Sensor
Device ID	0x110702 (1115906)
Transfer rate	COM2 (38.4 kBit/s)
Min. cycle time	2.3 ms
Process data width	Process data input 1 Bit Process data output 2 Bit
SIO mode support	yes
Compatible master port type	A
Output	
Switching type	The switching type of the sensor is adjustable. The default setting is: C/Q - Pin4: NPN normally open / dark-on, PNP normally closed / light-on, IO-Link /Q - Pin2: NPN normally closed / light-on, PNP normally open / dark-on
Signal output	2 push-pull (4 in 1) outputs, short-circuit protected, reverse polarity protected, overvoltage protected

## Technical Data

Switching voltage		max. 30 V DC
Switching current		max. 100 mA , resistive load
Usage category		DC-12 and DC-13
Voltage drop	$U_d$	$\leq 1.5$ V DC
Switching frequency	$f$	1650 Hz
Response time		300 $\mu$ s
<b>Conformity</b>		
Communication interface		IEC 61131-9
Product standard		EN 60947-5-2
Laser safety		EN 60825-1:2014
<b>Approvals and certificates</b>		
UL approval		E87056 , cULus Listed , class 2 power supply , type rating 1
FDA approval		IEC 60825-1:2007 Complies with 21 CFR 1040.10 and 1040.11 except for deviations pursuant to Laser Notice No. 50, dated June 24, 2007
<b>Ambient conditions</b>		
Ambient temperature		-40 ... 60 °C (-40 ... 140 °F) , fixed cable -25 ... 60 °C (-13 ... 140 °F) , movable cable not appropriate for conveyor chains
Storage temperature		-40 ... 70 °C (-40 ... 158 °F)
<b>Mechanical specifications</b>		
Housing width		13.9 mm
Housing height		33.8 mm
Housing depth		18.3 mm
Degree of protection		IP67 / IP69 / IP69K
Connection		300 mm fixed cable with M12 x 1, 4-pin connector
<b>Material</b>		
Housing		PC (Polycarbonate)
Optical face		PMMA
Mass		approx. 17 g
Cable length		0.3 m

## Connection

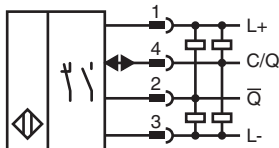

## Connection Assignment

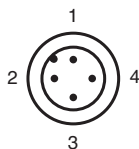

## Connection Assignment

Wire colors in accordance with EN 60947-5-2

1	BN	(brown)
2	WH	(white)
3	BU	(blue)
4	BK	(black)

## Assembly

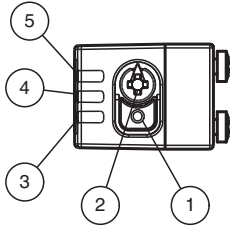

1	Light-on/dark-on changeover switch
2	Sensing range adjuster
3	Operating indicator / dark on
4	Signal indicator
5	Operating indicator / light on

## Characteristic Curve

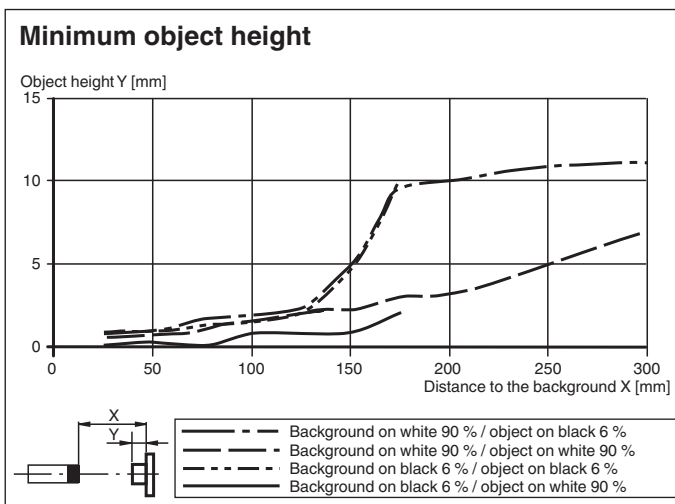









## Accessories

	<b>OMH-R101</b>	Mounting Clamp
	<b>OMH-R101-Front</b>	Mounting Clamp
	<b>OMH-4.1</b>	Mounting Clamp
	<b>OMH-ML6</b>	Mounting bracket
	<b>OMH-ML6-U</b>	Mounting bracket
	<b>OMH-ML6-Z</b>	Mounting bracket

Release date: 2023-04-05 Date of issue: 2023-04-05 Filename: 267075-0113\_eng.pdf

## Accessories

	<b>ICE2-8IOL-G65L-V1D</b>	EtherNet/IP IO-Link master with 8 inputs/outputs
	<b>ICE3-8IOL-G65L-V1D</b>	PROFINET IO IO-Link master with 8 inputs/outputs
	<b>ICE1-8IOL-G30L-V1D</b>	Ethernet IO-Link module with 8 inputs/outputs
	<b>ICE1-8IOL-G60L-V1D</b>	Ethernet IO-Link module with 8 inputs/outputs
	<b>ICE2-8IOL-K45P-RJ45</b>	EtherNet/IP IO-Link master with 8 inputs/outputs, DIN rail, push-in connectors
	<b>ICE2-8IOL-K45S-RJ45</b>	EtherNet/IP IO-Link master with 8 inputs/outputs, DIN rail, screw terminal
	<b>ICE3-8IOL-K45P-RJ45</b>	PROFINET IO IO-Link master with 8 inputs/outputs, DIN rail, push-in terminals
	<b>ICE3-8IOL-K45S-RJ45</b>	PROFINET IO IO-Link master with 8 inputs/outputs, DIN rail, screw terminal
	<b>IO-Link-Master02-USB</b>	IO-Link master, supply via USB port or separate power supply, LED indicators, M12 plug for sensor connection

## Configuration



- 1 - Light on / dark on changeover switch
- 2 - Sensing range / sensitivity adjuster
- 3 - Operating indicator / dark on
- 4 - Signal indicator
- 5 - Operating indicator / light on

To unlock the adjustment functions turn the sensing range adjuster for more than 180 degrees.

### Sensing Range / Sensitivity

Turn sensing range / sensitivity adjuster clockwise to increase sensing range / sensitivity.

Turn sensing range /sensitivity adjuster counterclockwise to decrease sensing range / sensitivity.

If the end of the adjustment range is reached, the signal indicator starts flashing with 8 Hz.

### Light on / Dark on Configuration

Press the light on / dark on changeover switch for more than 1 second (less than 4 seconds). The light on / dark on mode changes and the operating indicators are activated accordingly.

If you press the light on / dark on changeover switch for more than 4 seconds, the light on / dark on mode changes back to the original setting. On release of the light on / dark on changeover switch the current state is activated.

### Restore Factory Settings

Press the light on / dark on changeover switch for more than 10 seconds (less than 30 seconds) until all LEDs turn off. On release of the light on / dark on changeover switch the signal indicator turns on. After 5 seconds the sensor resumes operation with factory settings.

After 5 minutes of inactivity the sensing range / sensitivity adjustment is locked. In order to reactivate the sensing range / sensitivity adjustment, turn the sensing range / sensitivity adjuster for more than 180 degrees.