



Diffuse mode sensor

OBD1000-R101-EP-IO-0,3M-V3



- Miniature design with versatile mounting options
- Extended temperature range
-40 °C ... 60 °C
- High degree of protection IP69K
- IO-Link interface for service and process data

Diffuse mode sensor



Function

The miniature optical sensors are the first devices of their kind to offer an end-to-end solution in a small single standard design — from thru-beam sensor through to a distance measurement device. As a result of this design, the sensors are able to perform practically all standard automation tasks.

The DuraBeam laser sensors are durable and can be used in the same way as a standard sensor.

The use of Multi Pixel Technology gives the standard sensors a high level of flexibility and enables them to adapt more effectively to their operating environment.

Dimensions

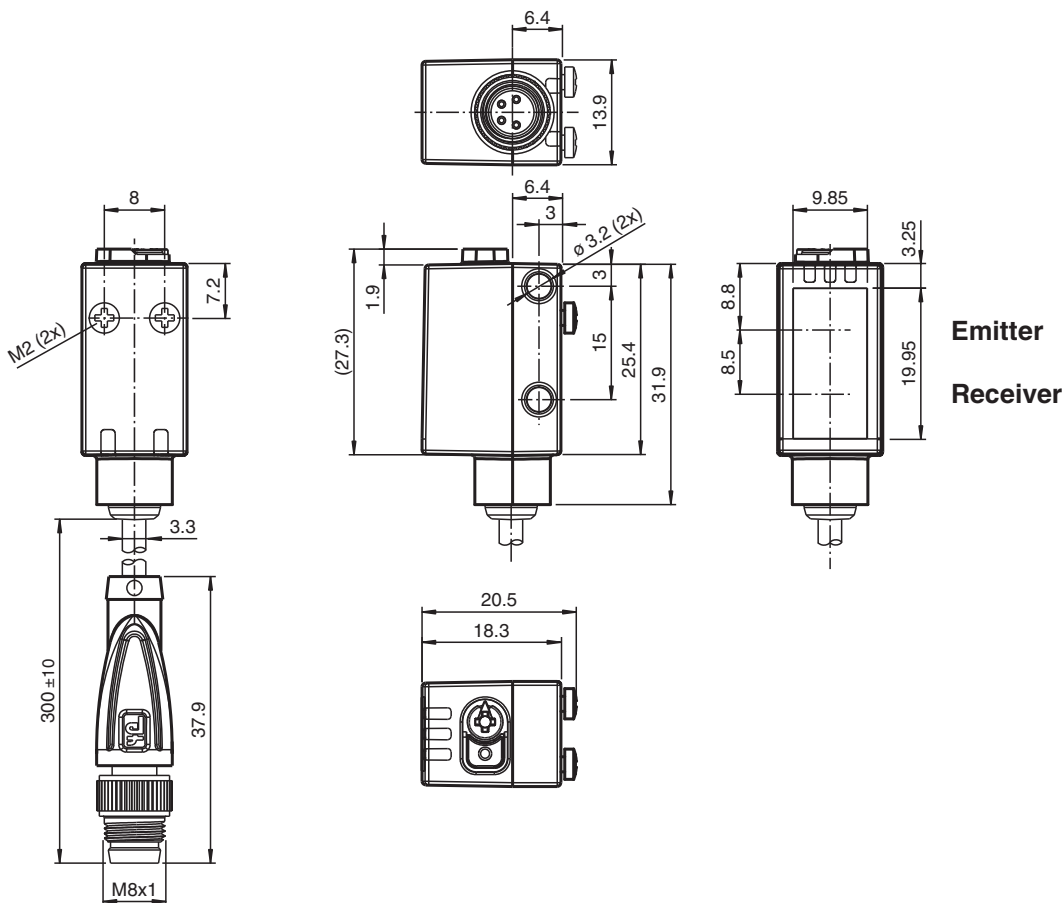

Release date: 2023-10-23 Date of issue: 2023-10-23 Filename: 267075-100047_eng.pdf

Technical Data

| General specifications | | |
|--------------------------------------|----------------|---|
| Detection range | | 2 ... 1000 mm |
| Detection range min. | | 20 ... 50 mm |
| Adjustment range | | 50 ... 1000 mm |
| Reference target | | standard white, 100 mm x 100 mm |
| Light source | | LED |
| Light type | | modulated visible red light |
| LED risk group labelling | | exempt group |
| Diameter of the light spot | | approx. 65 mm at a distance of 1000 mm |
| Opening angle | | 3.7 ° |
| Ambient light limit | | EN 60947-5-2 |
| Functional safety related parameters | | |
| MTTF _d | | 724 a |
| Mission Time (T _M) | | 20 a |
| Diagnostic Coverage (DC) | | 0 % |
| Indicators/operating means | | |
| Operation indicator | | LED green: constantly on - power on flashing (4Hz) - short circuit flashing with short break (1 Hz) - IO-Link mode |
| Function indicator | | LED yellow: constantly on - object detected constantly off - object not detected |
| Control elements | | Light-on/dark-on changeover switch |
| Control elements | | Sensing range adjuster |
| Electrical specifications | | |
| Operating voltage | U _B | 10 ... 30 V DC |
| Ripple | | max. 10 % |
| No-load supply current | I ₀ | < 25 mA at 24 V supply voltage |
| Protection class | | III |
| Interface | | |
| Interface type | | IO-Link (via C/Q = pin 4) |
| IO-Link revision | | 1.1 |
| Device ID | | 0x110101 (1114369) |
| Transfer rate | | COM2 (38.4 kBit/s) |
| Min. cycle time | | 2.3 ms |
| Process data width | | Process data input 1 Bit Process data output 2 Bit |
| SIO mode support | | yes |
| Compatible master port type | | A |
| Output | | |
| Switching type | | The switching type of the sensor is adjustable. The default setting is: C/Q - Pin4: NPN normally open / light-on, PNP normally closed / dark-on, IO-Link |
| Signal output | | 1 push-pull (4 in 1) output, short-circuit protected, reverse polarity protected, overvoltage protected |
| Switching voltage | | max. 30 V DC |
| Switching current | | max. 100 mA , resistive load |
| Usage category | | DC-12 and DC-13 |
| Voltage drop | U _d | ≤ 1.5 V DC |
| Switching frequency | f | 1000 Hz |
| Response time | | 0.5 ms |
| Conformity | | |
| Communication interface | | IEC 61131-9 |
| Product standard | | EN 60947-5-2 |
| Approvals and certificates | | |
| UL approval | | E87056 , cULus Listed , class 2 power supply , type rating 1 |

Release date: 2023-10-23 Date of issue: 2023-10-23 Filename: 267075-100047_eng.pdf

Technical Data

| Ambient conditions | |
|---------------------------|--|
| Ambient temperature | -40 ... 60 °C (-40 ... 140 °F) , fixed cable -25 ... 60 °C (-13 ... 140 °F) , movable cable not appropriate for conveyor chains |
| Storage temperature | -40 ... 70 °C (-40 ... 158 °F) |
| Mechanical specifications | |
| Housing width | 13.9 mm |
| Housing height | 33.8 mm |
| Housing depth | 18.3 mm |
| Degree of protection | IP67 / IP69 / IP69K |
| Connection | 300 mm fixed cable with M8 x 1, 3-pin connector |
| Material | |
| Housing | PC (Polycarbonate) |
| Optical face | PMMA |
| Mass | approx. 10 g |
| Cable length | 0.3 m |

Connection

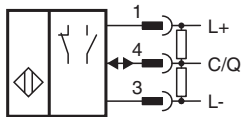

Connection Assignment



Wire colors in accordance with EN 60947-5-2

| | | |
|---|----|---------|
| 1 | BN | (brown) |
| 3 | BU | (blue) |
| 4 | BK | (black) |

Assembly

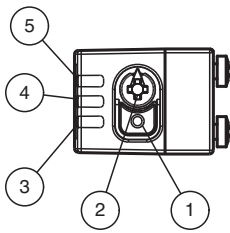

| | |
|---|------------------------------------|
| 1 | Light-on/dark-on changeover switch |
| 2 | Sensitivity adjuster |
| 3 | Operating indicator / dark on |
| 4 | Signal indicator |
| 5 | Operating indicator / light on |

Characteristic Curve

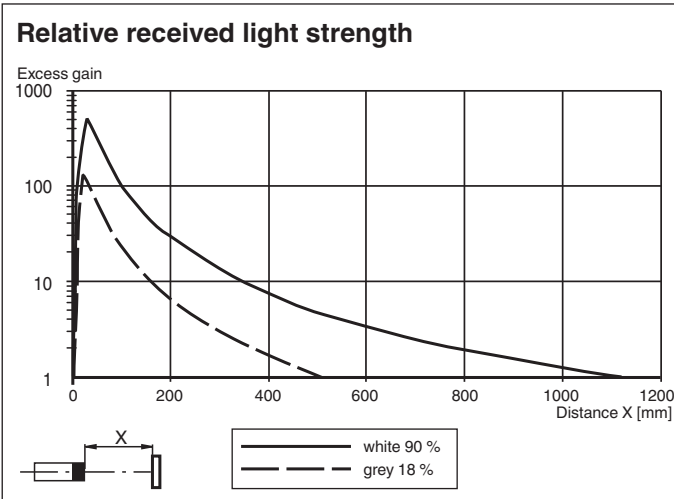
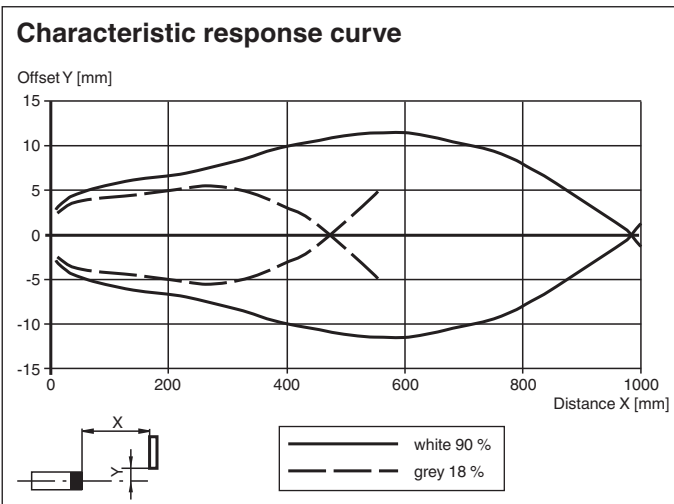

Release date: 2023-10-23 Date of issue: 2023-10-23 Filename: 267075-100047_eng.pdf

Characteristic Curve

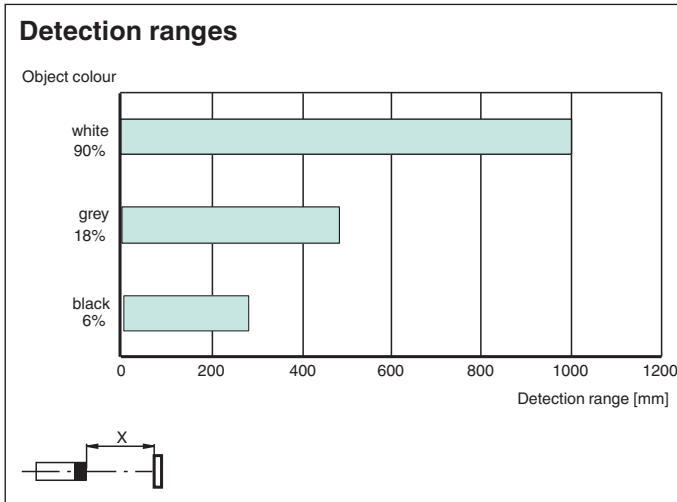

Release date: 2023-10-23 Date of issue: 2023-10-23 Filename: 267075-100047_eng.pdf

Configuration

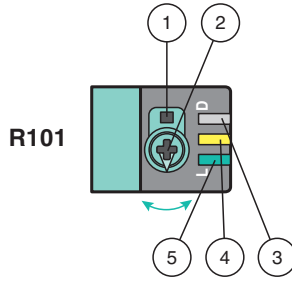

- 1 - Light on / dark on changeover switch
- 2 - Sensing range / sensitivity adjuster
- 3 - Operating indicator / dark on
- 4 - Signal indicator
- 5 - Operating indicator / light on

To unlock the adjustment functions turn the sensing range adjuster for more than 180 degrees.

Sensing Range / Sensitivity

Turn sensing range / sensitivity adjuster clockwise to increase sensing range / sensitivity.

Turn sensing range /sensitivity adjuster counterclockwise to decrease sensing range / sensitivity.

If the end of the adjustment range is reached, the signal indicator starts flashing with 8 Hz.

Light on / Dark on Configuration

Press the light on / dark on changeover switch for more than 1 second (less than 4 seconds). The light on / dark on mode changes and the operating indicators are activated accordingly.

If you press the light on / dark on changeover switch for more than 4 seconds, the light on / dark on mode changes back to the original setting. On release of the light on / dark on changeover switch the current state is activated.

Restore Factory Settings

Press the light on / dark on changeover switch for more than 10 seconds (less than 30 seconds) until all LEDs turn off. On release of the light on / dark on changeover switch the signal indicator turns on. After 5 seconds the sensor resumes operation with factory settings.

After 5 minutes of inactivity the sensing range / sensitivity adjustment is locked. In order to reactivate the sensing range / sensitivity adjustment, turn the sensing range / sensitivity adjuster for more than 180 degrees.