

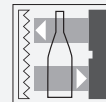

Retroreflective sensor (glass)

OBG5000-R101-2EP-IO-0,3M-V31



- Miniature design with versatile mounting options
- Detects transparent objects, i.e., clear glass, PET and transparent films
- Two machines in one: clear object detection or reflection operating mode with long range
- High degree of protection IP69K
- IO-Link interface for service and process data

Retroreflective sensor with polarization filter for clear object detection



Function

The miniature optical sensors are the first devices of their kind to offer an end-to-end solution in a small single standard design — from thru-beam sensor through to a distance measurement device. As a result of this design, the sensors are able to perform practically all standard automation tasks.

The DuraBeam laser sensors are durable and can be used in the same way as a standard sensor.

The use of Multi Pixel Technology gives the standard sensors a high level of flexibility and enables them to adapt more effectively to their operating environment.

Dimensions

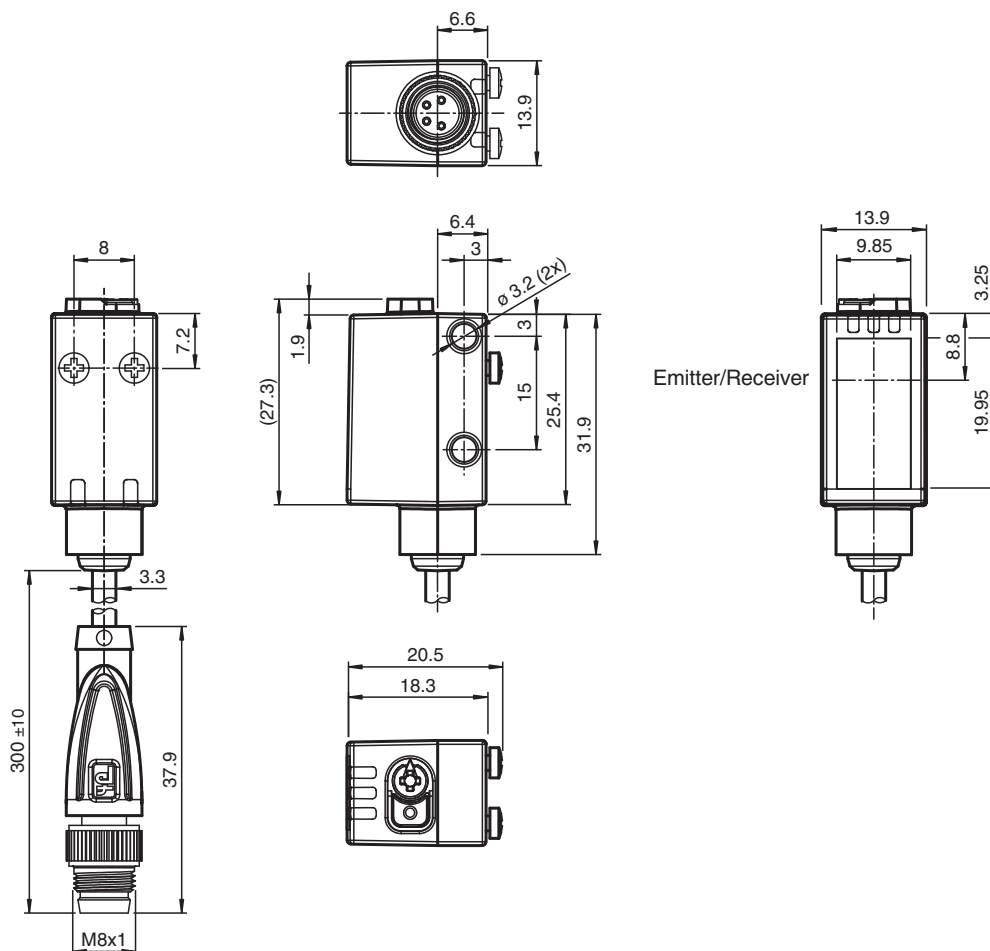

Release date: 2025-07-02 Date of issue: 2025-07-02 Filename: 267075-100068_eng.pdf

Technical Data

General specifications		
Effective detection range		0 ... 3.5 m in TEACH mode ; 0 ... 5 m at switch position "N"
Reflector distance		0 ... 3.5 m in TEACH mode ; 0 ... 5 m at switch position "N"
Threshold detection range		6 m
Reference target		H85-2 reflector
Light source		LED
Light type		modulated visible red light
LED risk group labelling		exempt group
Diameter of the light spot		approx. 170 mm at a distance of 3.5 m
Opening angle		approx. 5 °
Ambient light limit		EN 60947-5-2
Functional safety related parameters		
MTTF _d		600 a
Mission Time (T _M)		20 a
Diagnostic Coverage (DC)		0 %
Indicators/operating means		
Operation indicator		LED green: constantly on - power on flashing (4Hz) - short circuit flashing with short break (1 Hz) - IO-Link mode
Function indicator		Yellow LED: Permanently lit - light path clear Permanently off - object detected Flashing (4 Hz) - insufficient operating reserve
Control elements		Teach-In key
Control elements		5-step rotary switch for operating modes selection
Contrast detection levels		10 % - clean, water filled PET bottles 18 % - clear glass bottles 40 % - colored glass or opaque materials Adjustable via rotary switch
Electrical specifications		
Operating voltage	U _B	10 ... 30 V DC
Ripple		max. 10 %
No-load supply current	I ₀	< 25 mA at 24 V supply voltage
Protection class		III
Interface		
Interface type		IO-Link (via C/Q = pin 4)
IO-Link revision		1.1
Device ID		0x110A01 (1116673)
Transfer rate		COM2 (38.4 kBit/s)
Min. cycle time		2.3 ms
Process data width		Process data input 2 Bit Process data output 2 Bit
SIO mode support		yes
Compatible master port type		A
Output		
Switching type		The switching type of the sensor is adjustable. The default setting is: C/Q - Pin4: NPN normally open / dark-on, PNP normally closed / light-on, IO-Link /Q - Pin2: NPN normally closed / light-on, PNP normally open / dark-on
Signal output		2 push-pull (4 in 1) outputs, short-circuit protected, reverse polarity protected, overvoltage protected
Switching voltage		max. 30 V DC
Switching current		max. 100 mA , resistive load
Usage category		DC-12 and DC-13
Voltage drop	U _d	≤ 1.5 V DC
Switching frequency	f	500 Hz
Response time		1 ms
Conformity		

Technical Data

Communication interface	IEC 61131-9
Product standard	EN 60947-5-2
Approvals and certificates	
UL approval	E87056 , cULus Listed , class 2 power supply , type rating 1
Ambient conditions	
Ambient temperature	-20 ... 60 °C (-4 ... 140 °F) , movable cable not appropriate for conveyor chains
Storage temperature	-40 ... 70 °C (-40 ... 158 °F)
Mechanical specifications	
Degree of protection	IP67 / IP69 / IP69K
Connection	fixed cable 300 mm with M8 x 1 male connector; 4-pin
Material	
Housing	PC (Polycarbonate)
Optical face	PMMA
Mass	approx. 17 g
Dimensions	
Height	33.8 mm
Width	13.9 mm
Depth	18.3 mm
Cable length	0.3 m

Connection Assignment

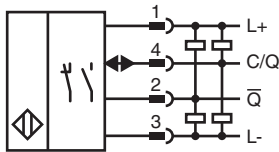

Connection Assignment



Wire colors in accordance with EN 60947-5-2

1	BN	(brown)
2	WH	(white)
3	BU	(blue)
4	BK	(black)

Assembly

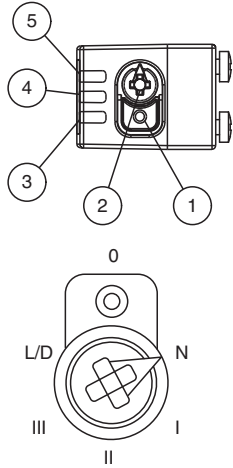

1	Teach-in button
2	Mode rotary switch
3	Operating indicator / dark on
4	Signal indicator
5	Operating indicator / light on

N	Normal mode
I	10 % contrast detection
II	18 % contrast detection
III	40 % contrast detection
L/D	Switching type
0	Keylock

Characteristic Curve

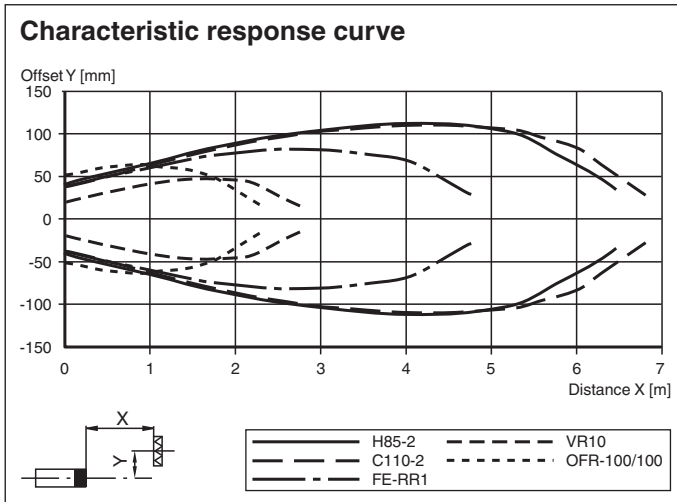

Relative received light strength in switch position "N"

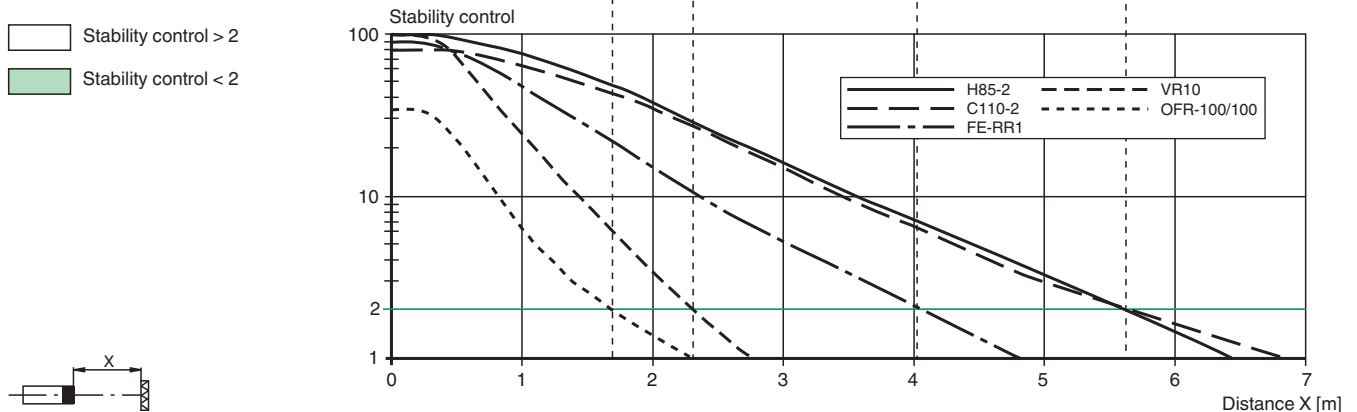
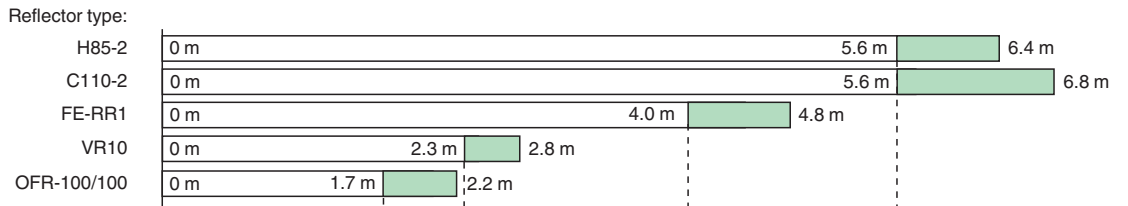

Release date: 2025-07-02 Date of issue: 2025-07-02 Filename: 267075-100068_eng.pdf

Commissioning

Teach-in

Use the rotary switch to select the required operating mode: Normal mode (N) or contrast level I – III.

To teach in a threshold or activate an operating mode, press the "TI" button until the yellow and green LEDs flash in phase (approx. 1 s). Release the "TI" button. Teach-in starts.

Successful teach-in is indicated by alternating flashing (2.5 Hz) of the yellow and green LEDs. The sensor will now operate in the selected operating mode with the taught-in threshold.

An unsuccessful teach-in is indicated by rapidly alternating flashing (8 Hz) of the yellow and green LEDs. After an unsuccessful teach-in, the sensor continues to operate with the previous valid setting after the relevant visual fault signal is issued.

Every taught-in switching threshold can be re-taught (overwritten) by pressing the "TI" button again.

Note: To ensure that the device functions reliably in Contrast mode, the device must be powered on at least 30 s before teach-in.

Setting the Device to Maximum Sensitivity

1. Use the rotary switch to select the Normal mode (N) position.
2. Press the "TI" button for > 4 s. The yellow and green LEDs will go out.
3. Release the "TI" button.

The settings will be reset to maximum sensitivity. After successfully resetting, the yellow and green LEDs will flash alternately (2.5 Hz).

Switching between light on/dark on

1. Use the rotary switch to select the light on/dark on (L/D) position.
2. Press the "TI" button for > 1 s. The respective operating indicator LED (L/D) will illuminate green and the switching type will change.
3. To reset the switching type, press the "TI" button for > 4 s. The respective operating indicator LED (L/D) will illuminate green and the operating indicator will be reset to the most recently active switching type.

Reset to Default Settings

1. Use the rotary switch to select the O position.
2. Press the "TI" button for > 10 s. The yellow and the green LEDs will both switch off.
3. Release the "TI" button. The yellow LED is on. After resetting, the sensor will operate with the following default settings:
 - Normal mode (N)
 - Maximum sensitivity adjustment
 - Dark on
 - Pin 2 (white core): antivalent switching output