



Triangulation sensor (SbR)

OQT150-R101-2EP-IO-0,3M-V31-L



- Miniature design with versatile mounting options
- Multi Pixel Technology (MPT) - flexibility and adaptability
- Reduction of device variety - several switch points within one sensor
- DuraBeam Laser Sensors - durable and employable like an LED
- Reliable detection of all surfaces, independent of color and structure
- IO-Link interface for service and process data

Switching diffuse mode sensor with measurement core technology, 150 mm detection range, red laser light, laser class 1, IO-Link, 2 x push-pull output, fixed cable with M8 plug



IO-Link

Function

The miniature optical sensors are the first devices of their kind to offer an end-to-end solution in a small single standard design — from thru-beam sensor through to a distance measurement device. As a result of this design, the sensors are able to perform practically all standard automation tasks.

The DuraBeam laser sensors are durable and can be used in the same way as a standard sensor.

The use of Multi Pixel Technology gives the standard sensors a high level of flexibility and enables them to adapt more effectively to their operating environment.

Dimensions

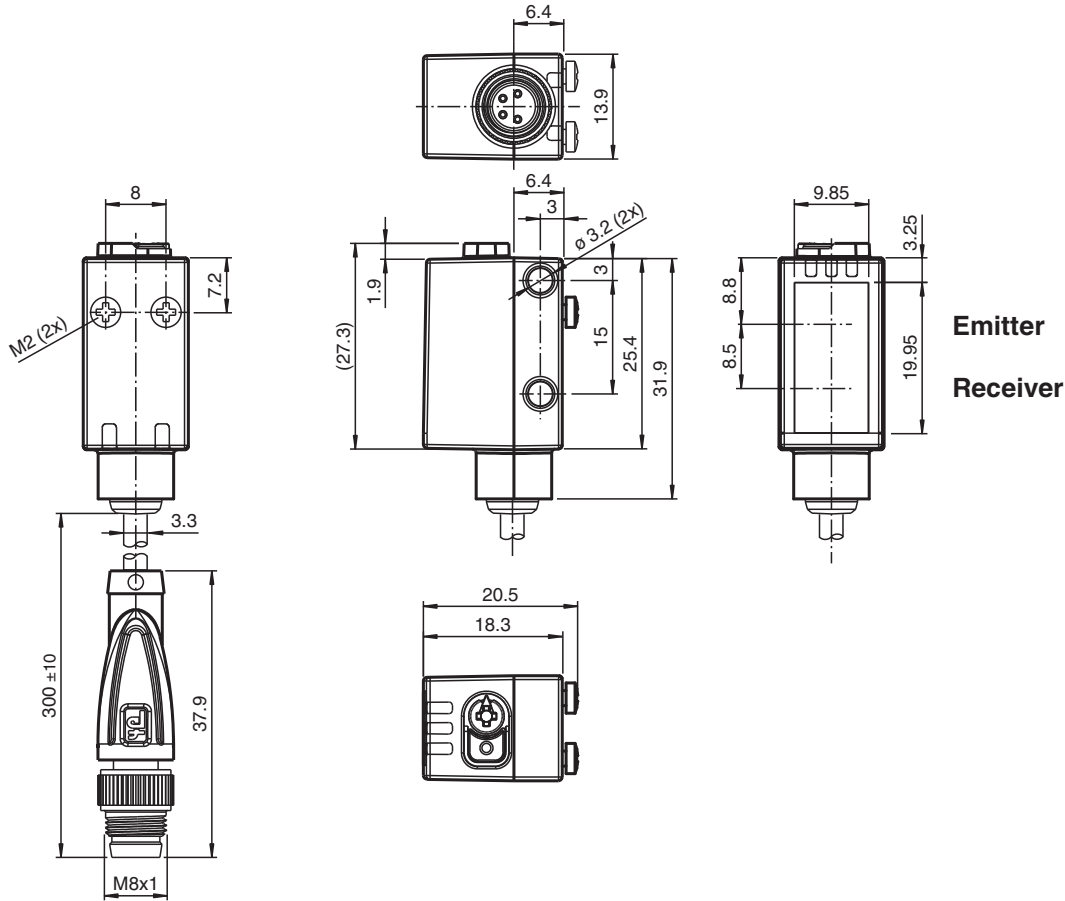

Technical Data

General specifications

| | |
|---|--|
| Detection range | 8 ... 150 mm |
| Detection range min. | 8 ... 20 mm |
| Detection range max. | 8 ... 150 mm |
| Adjustment range | 20 ... 150 mm |
| Reference target | standard white, 100 mm x 100 mm |
| Light source | laser diode |
| Light type | modulated visible red light |
| Laser nominal ratings | |
| Note | LASER LIGHT , DO NOT STARE INTO BEAM |
| Laser class | 1 |
| Wave length | 680 nm |
| Beam divergence | > 5 mrad ; d63 < 1 mm in the range of 50 mm ... 250 mm |
| Pulse length | 3 μs |
| Repetition rate | approx. 3 kHz |
| max. pulse energy | 15.2 nJ |
| Black-white difference (6 %/90 %) | < 3 % at 150 mm |
| Diameter of the light spot | approx. 2 mm at a distance of 150 mm |
| Opening angle | approx. 1 ° |
| Ambient light limit | EN 60947-5-2 : 30000 Lux |
| Functional safety related parameters | |
| MTTF _d | 560 a |

Release date: 2023-03-28 Date of issue: 2023-03-28 Filename: 267075-100169_eng.pdf

Technical Data

| | | |
|-----------------------------------|----------------|---|
| Mission Time (T _M) | | 20 a |
| Diagnostic Coverage (DC) | | 0 % |
| Indicators/operating means | | |
| Operation indicator | | LED green: constantly on - power on flashing (4Hz) - short circuit flashing with short break (1 Hz) - IO-Link mode |
| Function indicator | | LED yellow: constantly on - switch output active constantly off - switch output inactive |
| Control elements | | Teach-In key |
| Control elements | | 5-step rotary switch for operating modes selection |
| Electrical specifications | | |
| Operating voltage | U _B | 10 ... 30 V DC |
| Ripple | | max. 10 % |
| No-load supply current | I ₀ | < 20 mA at 24 V supply voltage |
| Protection class | | III |
| Interface | | |
| Interface type | | IO-Link (via C/Q = pin 4) |
| IO-Link revision | | 1.1 |
| Device profile | | Smart Sensor |
| Device ID | | 0x110802 (1116162) |
| Transfer rate | | COM2 (38.4 kBit/s) |
| Min. cycle time | | 2.3 ms |
| Process data width | | Process data input 2 Bit Process data output 2 Bit |
| SIO mode support | | yes |
| Compatible master port type | | A |
| Output | | |
| Switching type | | The default setting is: C/Q - Pin4: NPN normally open, PNP normally closed, IO-Link Q2 - Pin2: NPN normally-open, PNP normally-closed |
| Signal output | | 2 push-pull (4 in 1) outputs, short-circuit protected, reverse polarity protected, overvoltage protected |
| Switching voltage | | max. 30 V DC |
| Switching current | | max. 100 mA , resistive load |
| Usage category | | DC-12 and DC-13 |
| Voltage drop | U _d | ≤ 1.5 V DC |
| Switching frequency | f | 217 Hz |
| Response time | | 2.3 ms |
| Conformity | | |
| Communication interface | | IEC 61131-9 |
| Product standard | | EN 60947-5-2 |
| Laser safety | | EN 60825-1:2014 |
| Approvals and certificates | | |
| UL approval | | E87056 , cULus Listed , class 2 power supply , type rating 1 |
| FDA approval | | IEC 60825-1:2007 Complies with 21 CFR 1040.10 and 1040.11 except for deviations pursuant to Laser Notice No. 50, dated June 24, 2007 |
| Ambient conditions | | |
| Ambient temperature | | -40 ... 60 °C (-40 ... 140 °F) , fixed cable -25 ... 60 °C (-13 ... 140 °F) , movable cable not appropriate for conveyor chains |
| Storage temperature | | -40 ... 70 °C (-40 ... 158 °F) |
| Mechanical specifications | | |
| Housing width | | 13.9 mm |
| Housing height | | 33.8 mm |
| Housing depth | | 18.3 mm |
| Degree of protection | | IP67 / IP69 / IP69K |

Technical Data

| | |
|--------------|--|
| Connection | fixed cable 300 mm with M8 x 1 male connector; 4-pin |
| Material | |
| Housing | PC (Polycarbonate) |
| Optical face | PMMA |
| Mass | approx. 17 g |
| Cable length | 0.3 m |

Connection

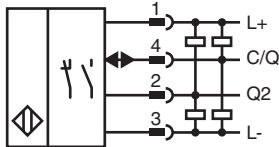

Connection Assignment



Wire colors in accordance with EN 60947-5-2

| | | |
|---|----|---------|
| 1 | BN | (brown) |
| 2 | WH | (white) |
| 3 | BU | (blue) |
| 4 | BK | (black) |

Assembly

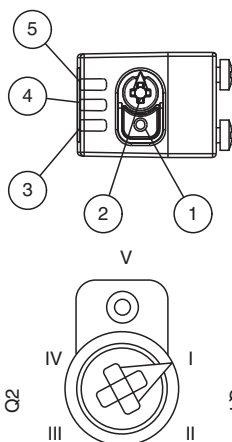

| | |
|---|----------------------------|
| 1 | TEACH-IN button |
| 2 | Mode rotary switch |
| 3 | Switch output indicator Q2 |
| 4 | Switch output indicator Q1 |
| 5 | Operating indicator |

| | |
|-----|----------------------------------|
| I | Switch output 1 / switch point B |
| II | Switch output 1 / switch point A |
| III | Switch output 2 / switch point A |
| IV | Switch output 2 / B |
| V | Keylock |

Characteristic Curve

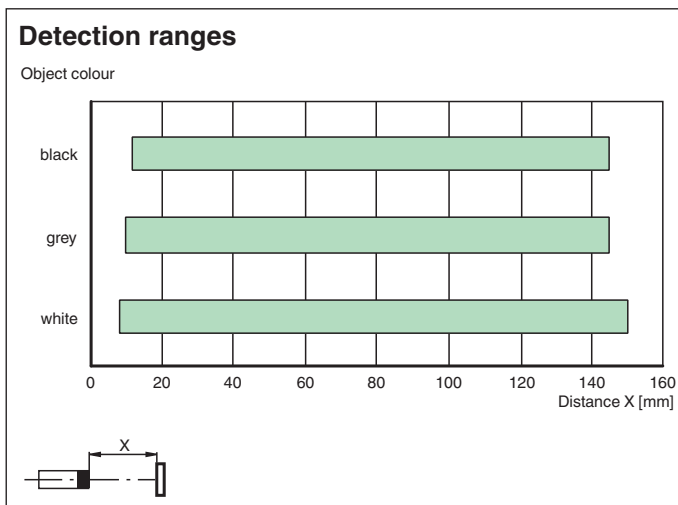
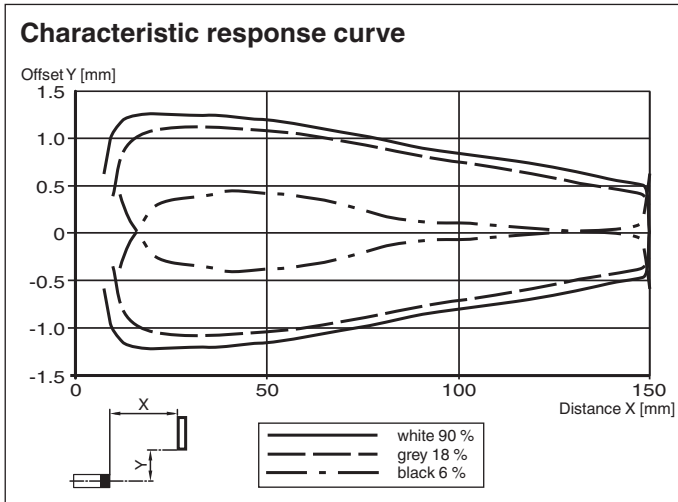



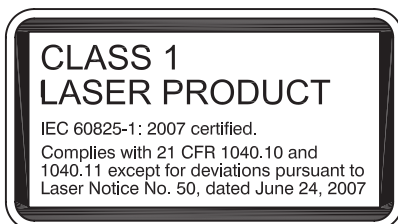













Safety Information



Release date: 2023-03-28 Date of issue: 2023-03-28 Filename: 267075-100169_eng.pdf

Accessories

| | | |
|---|-----------------------------|--|
|  | OMH-R101 | Mounting Clamp |
|  | OMH-R101-Front | Mounting Clamp |
|  | OMH-4.1 | Mounting Clamp |
|  | OMH-ML6 | Mounting bracket |
|  | OMH-ML6-U | Mounting bracket |
|  | OMH-ML6-Z | Mounting bracket |
|  | V31-GM-2M-PUR | Female cordset single-ended M8 straight A-coded, 4-pin, PUR cable grey |
|  | V31-WM-2M-PUR | Female cordset single-ended M8 angled A-coded, 4-pin, PUR cable grey |
|  | ICE2-8IOL-G65L-V1D | EtherNet/IP IO-Link master with 8 inputs/outputs |
|  | ICE3-8IOL-G65L-V1D | PROFINET IO IO-Link master with 8 inputs/outputs |
|  | ICE1-8IOL-G30L-V1D | Ethernet IO-Link module with 8 inputs/outputs |
|  | ICE1-8IOL-G60L-V1D | Ethernet IO-Link module with 8 inputs/outputs |
|  | ICE2-8IOL-K45P-RJ45 | EtherNet/IP IO-Link master with 8 inputs/outputs, DIN rail, push-in connectors |
|  | ICE2-8IOL-K45S-RJ45 | EtherNet/IP IO-Link master with 8 inputs/outputs, DIN rail, screw terminal |
|  | ICE3-8IOL-K45P-RJ45 | PROFINET IO IO-Link master with 8 inputs/outputs, DIN rail, push-in terminals |
|  | ICE3-8IOL-K45S-RJ45 | PROFINET IO IO-Link master with 8 inputs/outputs, DIN rail, screw terminal |
|  | IO-Link-Master02-USB | IO-Link master, supply via USB port or separate power supply, LED indicators, M12 plug for sensor connection |

Teach-In

You can use the rotary switch to select the relevant switching threshold A and/or B for teaching in for switch signal **Q1** or **Q2**. The yellow LEDs indicate the current state of the selected output. To store a threshold value, press and hold the "TI" button until the yellow and green LEDs flash in phase (approx. 1 s). Teach-In starts when the "TI" button is released. Successful Teach-In is indicated by alternating flashing (2.5 Hz) of the yellow and green LEDs. An unsuccessful Teach-In is indicated by rapidly alternating flashing (8 Hz) of the yellow and green LEDs. After an unsuccessful Teach-In, the sensor continues to operate with the previous valid setting after the relevant visual fault signal is issued. Different switching modes can be defined by teaching in the relevant distance measured values for the switching thresholds A and B: Single point mode:

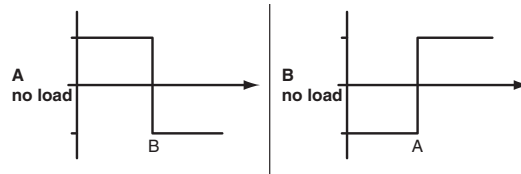

Window mode:

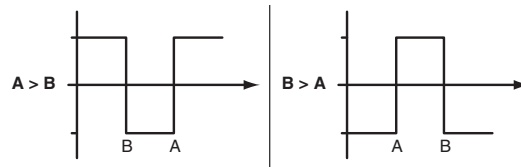

Every taught-in switching threshold can be retaught (overwritten) by pressing the „TI“ button again. Pressing and holding the "TI" button for > 4 s completely deletes the taught-in value. The yellow and green LEDs go out simultaneously to indicate that this procedure has been completed. Successful resetting is indicated by alternating flashing (2.5 Hz) of the yellow and green LEDs.

Resetting to Factory Default Settings

Press the „TI“ button for > 10 s in rotary switch position ‚O‘ to reset to factory default settings. The yellow and green LEDs go out simultaneously to indicate the resetting. Resetting process starts when the "TI" button is released and is indicated by the yellow LED. After the process the sensor works with factory default settings, immediately.

OMT:

- Factory default settings switch signal Q1: Switch signal active, window mode
- Factory default settings switch signal Q2: Switch signal active, window mode

OQT:

- Factory default settings switch signal Q1: Switch signal active, BGS mode (background suppression)
- Factory default settings switch signal Q2: Switch signal active, BGS mode (background suppression)

Configuration

Configuring different operating modes via the IO-Link interface

The devices are equipped with an IO-Link interface as standard for diagnostics and parameterization tasks to ensure optimum adjustment of the sensors to the relevant application. Four different operating modes can be set, among other features:

Background suppression operating mode (one switch point):

- Detection of objects irrespective of type and color in a defined detection range. Objects in the background are suppressed.



Background evaluation operating mode (one switch point):

- Detection of objects irrespective of type and color against a defined background. Reliable detection of objects at close range

Release date: 2023-03-28 Date of issue: 2023-03-28 Filename: 267075-100169_eng.pdf

(detection range ≥ 0 mm). The background serves as reference.



Single point mode operating mode (one switch point):

- Detection of objects irrespective of type and color in a defined detection range. Objects in the background are suppressed.
- The switch point corresponds exactly to the set point.



Window mode operating mode (two switch points):

- Detection of objects irrespective of type and color in a defined detection range. Reliable detection when object leaves the detection range.
- Window mode with two switch points.



Center window mode operating mode (one switch point):

- Detection of objects irrespective of type and color in a defined detection range. Sets a defined window around a given object. Objects outside this window are not detected.
- Window mode with one switch point.



Two point mode operating mode (hysteresis operating mode):

- Detection of objects irrespective of type and color between a defined switch-on and switch-off point.

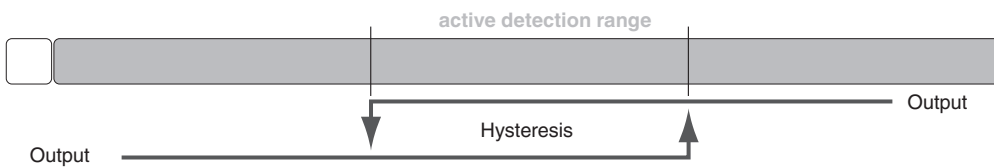

Inactive operating mode:

- Evaluation of switching signals is deactivated.

The associated IODD device description file can be found in the download area at www.pepperl-fuchs.com.