



Distance sensor

OMT50-R101-2EP-IO-L



- Miniature design with versatile mounting options
- Space-saving distance sensors in small standardized design
- Multi Pixel Technology (MPT) - exact and precise signal evaluation
- DuraBeam Laser Sensors - durable and employable like an LED
- IO-Link interface for service and process data

Measurement to object, 50 mm detection range, red laser light, laser class 1, measured value via IO-Link, 2 x push-pull output, 2 m fixed cable



Function

The miniature optical sensors are the first devices of their kind to offer an end-to-end solution in a small single standard design — from thru-beam sensor through to a distance measurement device. As a result of this design, the sensors are able to perform practically all standard automation tasks.

The DuraBeam laser sensors are durable and can be used in the same way as a standard sensor.

The use of Multi Pixel Technology gives the standard sensors a high level of flexibility and enables them to adapt more effectively to their operating environment.

Dimensions

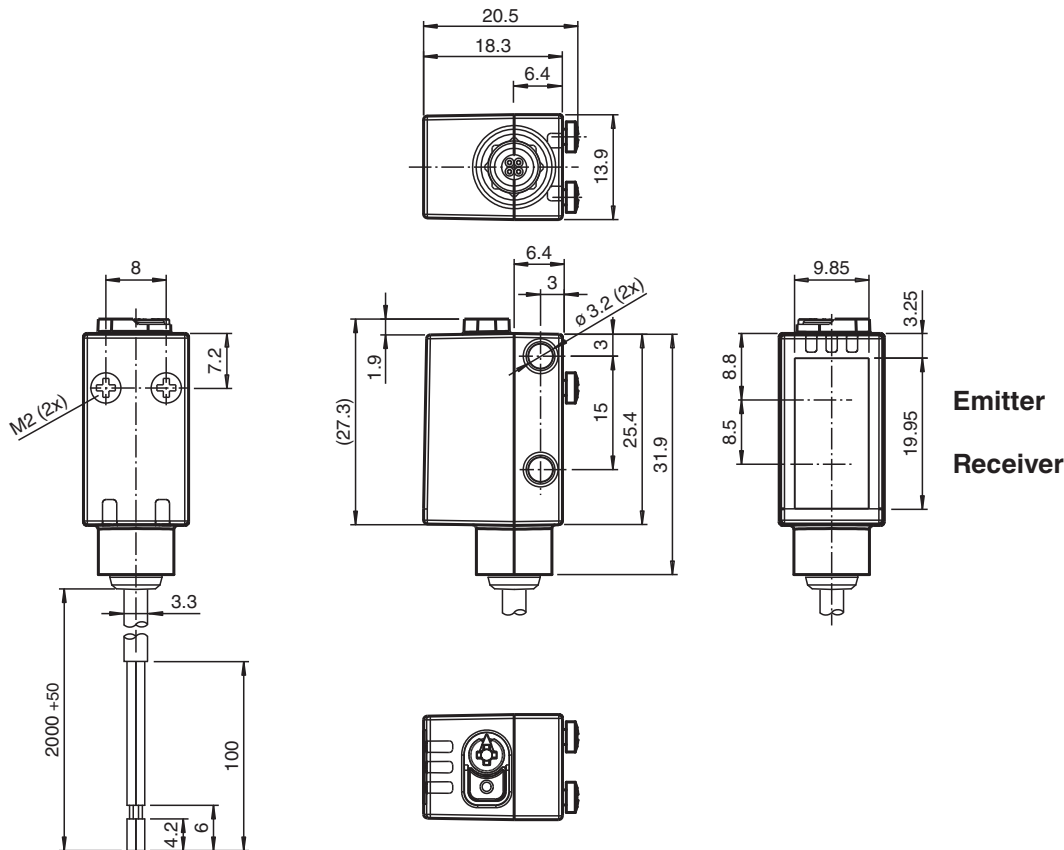

Release date: 2024-10-31 Date of issue: 2024-10-31 Filename: 267075-100212_eng.pdf

Technical Data

General specifications		
Measuring range		20 ... 50 mm
Reference target		standard white, 100 mm x 100 mm
Light source		laser diode
Light type		modulated visible red light
Laser nominal ratings		
Note		LASER LIGHT , DO NOT STARE INTO BEAM
Laser class		1
Wave length		680 nm
Beam divergence		> 5 mrad d63 d63 < 1 mm in the range of 50 mm ... 250 mm
Pulse length		3 µs
Repetition rate		approx. 3 kHz
max. pulse energy		15.2 nJ
Angle deviation		max. +/- 1.5 °
Diameter of the light spot		approx. 0.5 mm at a distance of 50 mm
Opening angle		approx. 0.6 °
Ambient light limit		EN 60947-5-2 : 30000 Lux
Resolution		0.01 mm
Functional safety related parameters		
MTTF _d		560 a
Mission Time (T _M)		20 a
Diagnostic Coverage (DC)		0 %
Indicators/operating means		
Operation indicator		LED green: constantly on - power on flashing (4Hz) - short circuit flashing with short break (1 Hz) - IO-Link mode
Function indicator		LED yellow: constantly on - switch output active constantly off - switch output inactive
Control elements		Teach-In key
Control elements		5-step rotary switch for operating modes selection
Electrical specifications		
Operating voltage	U _B	10 ... 30 V DC
Ripple		max. 10 %
No-load supply current	I ₀	< 25 mA at 24 V supply voltage
Protection class		III
Interface		
Interface type		IO-Link (via C/Q = pin 4)
IO-Link revision		1.1
Device profile		Smart Sensor
Device ID		0x110902 (1116418)
Transfer rate		COM2 (38.4 kBit/s)
Min. cycle time		3 ms
Process data width		Process data input 3 Byte Process data output 2 Bit
SIO mode support		yes
Compatible master port type		A
Output		
Switching type		The default setting is: C/Q - BK: NPN normally open, PNP normally closed, IO-Link Q2 - WH: NPN normally open, PNP normally closed
Signal output		2 push-pull (4 in 1) outputs, short-circuit protected, reverse polarity protected, overvoltage protected
Switching voltage		max. 30 V DC
Switching current		max. 100 mA , resistive load

Technical Data

Usage category	DC-12 and DC-13	
Voltage drop	U_d	≤ 1.5 V DC
Response time	2 ms	
Conformity		
Communication interface	IEC 61131-9	
Product standard	EN 60947-5-2	
Laser safety	EN 60825-1:2014	
Measurement accuracy		
Temperature drift	20 μ m/K	
Warm up time	5 min	
Repeat accuracy	≤ 0.1 mm	
Linearity error	± 0.2 mm	
Approvals and certificates		
UL approval	E87056 , cULus Listed , class 2 power supply , type rating 1	
FDA approval	IEC 60825-1:2007 Complies with 21 CFR 1040.10 and 1040.11 except for deviations pursuant to Laser Notice No. 50, dated June 24, 2007	
Ambient conditions		
Ambient temperature	10 ... 60 °C (50 ... 140 °F)	
Storage temperature	-40 ... 70 °C (-40 ... 158 °F)	
Mechanical specifications		
Degree of protection	IP67 / IP69 / IP69K	
Connection	2 m fixed cable	
Material		
Housing	PC (Polycarbonate)	
Optical face	PMMA	
Mass	approx. 36 g	
Dimensions		
Height	41.4 mm	
Width	13.9 mm	
Depth	18.3 mm	
Cable length	2 m	

Connection

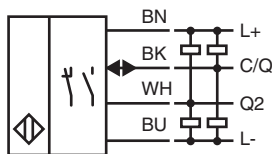

Assembly

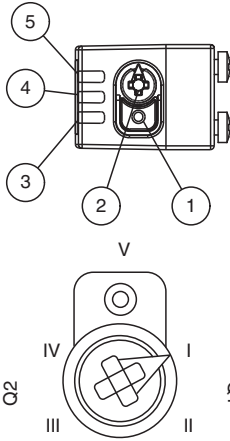

1	TEACH-IN button
2	Mode rotary switch
3	Switch output indicator Q2
4	Switch output indicator Q1
5	Operating indicator

I	Switch output 1 / switch point B
II	Switch output 1 / switch point A
III	Switch output 2 / switch point A
IV	Switch output 2 / B
V	Keylock

Safety Information

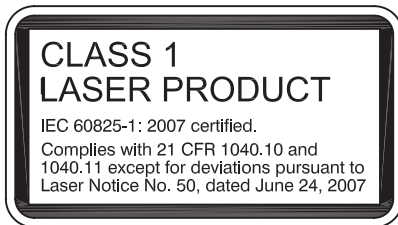

Release date: 2024-10-31 Date of issue: 2024-10-31 Filename: 267075-100212_eng.pdf

Teach-In

You can use the rotary switch to select the relevant switching threshold A and/or B for teaching in for switch signal **Q1** or **Q2**. The yellow LEDs indicate the current state of the selected output. To store a threshold value, press and hold the "TI" button until the yellow and green LEDs flash in phase (approx. 1 s). Teach-In starts when the "TI" button is released. Successful Teach-In is indicated by alternating flashing (2.5 Hz) of the yellow and green LEDs. An unsuccessful Teach-In is indicated by rapidly alternating flashing (8 Hz) of the yellow and green LEDs. After an unsuccessful Teach-In, the sensor continues to operate with the previous valid setting after the relevant visual fault signal is issued. Different switching modes can be defined by teaching in the relevant distance measured values for the switching thresholds A and B: Single point mode:

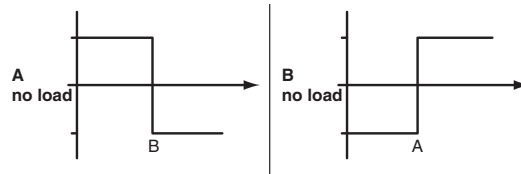

Window mode:

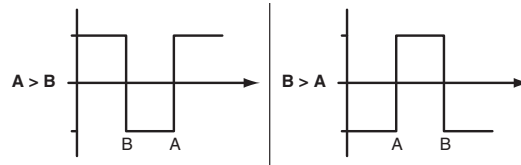

Every taught-in switching threshold can be retaught (overwritten) by pressing the „TI“ button again. Pressing and holding the "TI" button for > 4 s completely deletes the taught-in value. The yellow and green LEDs go out simultaneously to indicate that this procedure has been completed. Successful resetting is indicated by alternating flashing (2.5 Hz) of the yellow and green LEDs.

Resetting to Factory Default Settings

Press the „TI“ button for > 10 s in rotary switch position ‚O‘ to reset to factory default settings. The yellow and green LEDs go out simultaneously to indicate the resetting. Resetting process starts when the "TI" button is released and is indicated by the yellow LED. After the process the sensor works with factory default settings, immediately.

OMT:

- Factory default settings switch signal Q1: Switch signal active, window mode
- Factory default settings switch signal Q2: Switch signal active, window mode

OQT:

- Factory default settings switch signal Q1: Switch signal active, BGS mode (background suppression)
- Factory default settings switch signal Q2: Switch signal active, BGS mode (background suppression)

Configuration

Setting different operating modes via the IO-Link interface

The devices are equipped with an IO-Link interface as standard for diagnostics and parameterization tasks to ensure optimum adjustment of the sensors to the relevant application.

Single point mode operating mode (one switch point):

- "Detection of objects irrespective of type and color in a defined detection range. Objects in the background are suppressed.
- "The switch point corresponds exactly to the set point.



Release date: 2024-10-31 Date of issue: 2024-10-31 Filename: 267075-100212_eng.pdf

Window mode operating mode (two switch points):

- Detection of objects irrespective of type and color in a defined detection range. Reliable detection when object leaves the detection range.
- Window mode with two switch points.



Center window mode operating mode (one switch point):

- Detection of objects irrespective of type and color in a defined detection range. Sets a defined window around a given object. Objects outside this window are not detected.
- Window mode with one switch point.



Two point mode operating mode (hysteresis operating mode):

- Detection of objects irrespective of type and color between a defined switch-on and switch-off point.

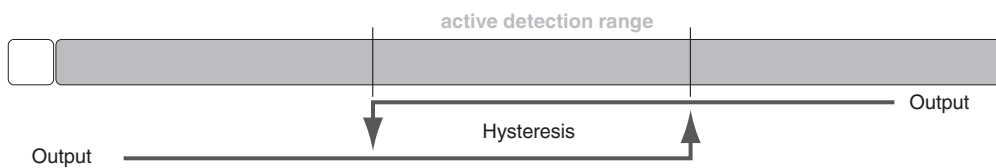

Inactive operating mode:

- Evaluation of switching signals is deactivated.

The associated IODD device description file can be found in the download area at www.pepperl-fuchs.com.