



Retroreflective sensor OBR7500-R101-P1-Y0429



- Miniature design with versatile mounting options
- Extended temperature range
-40 °C ... 60 °C
- High degree of protection IP69K

Retroreflective sensor with polarization filter



Function

The miniature optical sensors are the first devices of their kind to offer an end-to-end solution in a small single standard design — from thru-beam sensor through to a distance measurement device. As a result of this design, the sensors are able to perform practically all standard automation tasks.

The DuraBeam laser sensors are durable and can be used in the same way as a standard sensor.

The use of Multi Pixel Technology gives the standard sensors a high level of flexibility and enables them to adapt more effectively to their operating environment.

Dimensions

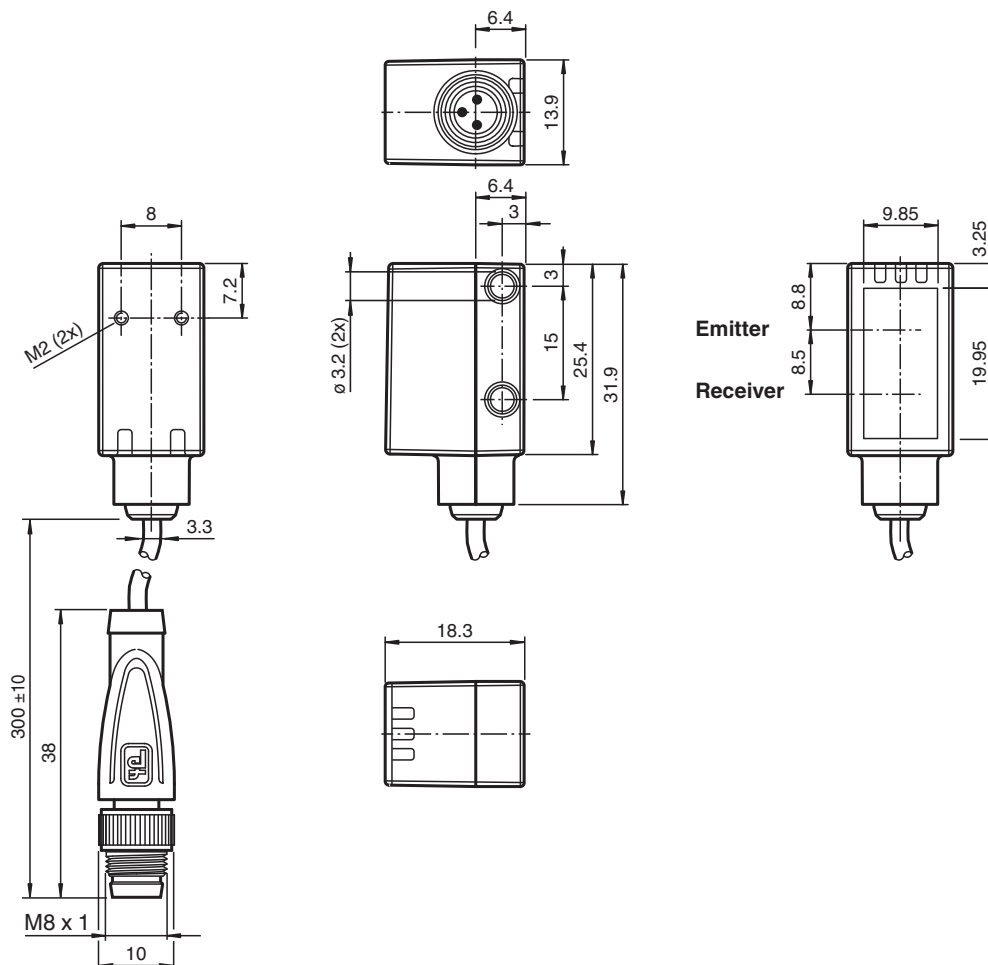

Release date: 2023-03-28 Date of issue: 2023-03-28 Filename: 267075-100429_eng.pdf

Technical Data

General specifications		
Effective detection range		0 ... 7.5 m
Reflector distance		0.03 ... 7.5 m
Threshold detection range		10 m
Reference target		H85-2 reflector
Light source		LED
Light type		modulated visible red light
LED risk group labelling		exempt group
Polarization filter		yes
Diameter of the light spot		approx. 65 mm at a distance of 1 m
Opening angle		3.7 °
Ambient light limit		EN 60947-5-2
Functional safety related parameters		
MTTF _d		724 a
Mission Time (T _M)		20 a
Diagnostic Coverage (DC)		0 %
Indicators/operating means		
Operation indicator		Green LED: Permanently lit - power on Flashing (4 Hz) - short circuit
Function indicator		Yellow LED: Permanently lit - light path clear Permanently off - object detected Flashing (4 Hz) - insufficient operating reserve
Electrical specifications		
Operating voltage	U _B	10 ... 30 V DC
Ripple		max. 10 %
No-load supply current	I ₀	< 25 mA at 24 V supply voltage
Protection class		III
Output		
Switching type		The default setting is: Q - Pin4: NPN normally closed / light-on, PNP normally open / dark-on
Signal output		1 push-pull (4 in 1) output, short-circuit protected, reverse polarity protected, overvoltage protected
Switching voltage		max. 30 V DC
Switching current		max. 100 mA , resistive load
Usage category		DC-12 and DC-13
Voltage drop	U _d	≤ 1.5 V DC
Switching frequency	f	1000 Hz
Response time		0.5 ms
Conformity		
Communication interface		IEC 61131-9
Product standard		EN 60947-5-2
Approvals and certificates		
UL approval		E87056 , cULus Listed , class 2 power supply , type rating 1
Ambient conditions		
Ambient temperature		-40 ... 60 °C (-40 ... 140 °F) , fixed cable -25 ... 60 °C (-13 ... 140 °F) , movable cable not appropriate for conveyor chains
Storage temperature		-40 ... 70 °C (-40 ... 158 °F)
Mechanical specifications		
Housing width		13.9 mm
Housing height		33.8 mm
Housing depth		18.3 mm
Degree of protection		IP67 / IP69 / IP69K
Connection		300 mm fixed cable with M8 x 1, 3-pin connector
Material		

Release date: 2023-03-28 Date of issue: 2023-03-28 Filename: 267075-100429_eng.pdf

Technical Data

Housing	PC (Polycarbonate)
Optical face	PMMA
Mass	approx. 15 g
Cable length	0.3 m

Connection

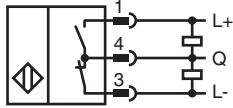

Connection Assignment

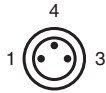

Wire colors in accordance with EN 60947-5-2

1	BN	(brown)
3	BU	(blue)
4	BK	(black)

Assembly

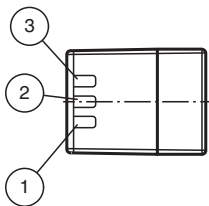

1	Operating indicator / dark on
2	Signal indicator
3	Operating indicator / light on

Characteristic Curve

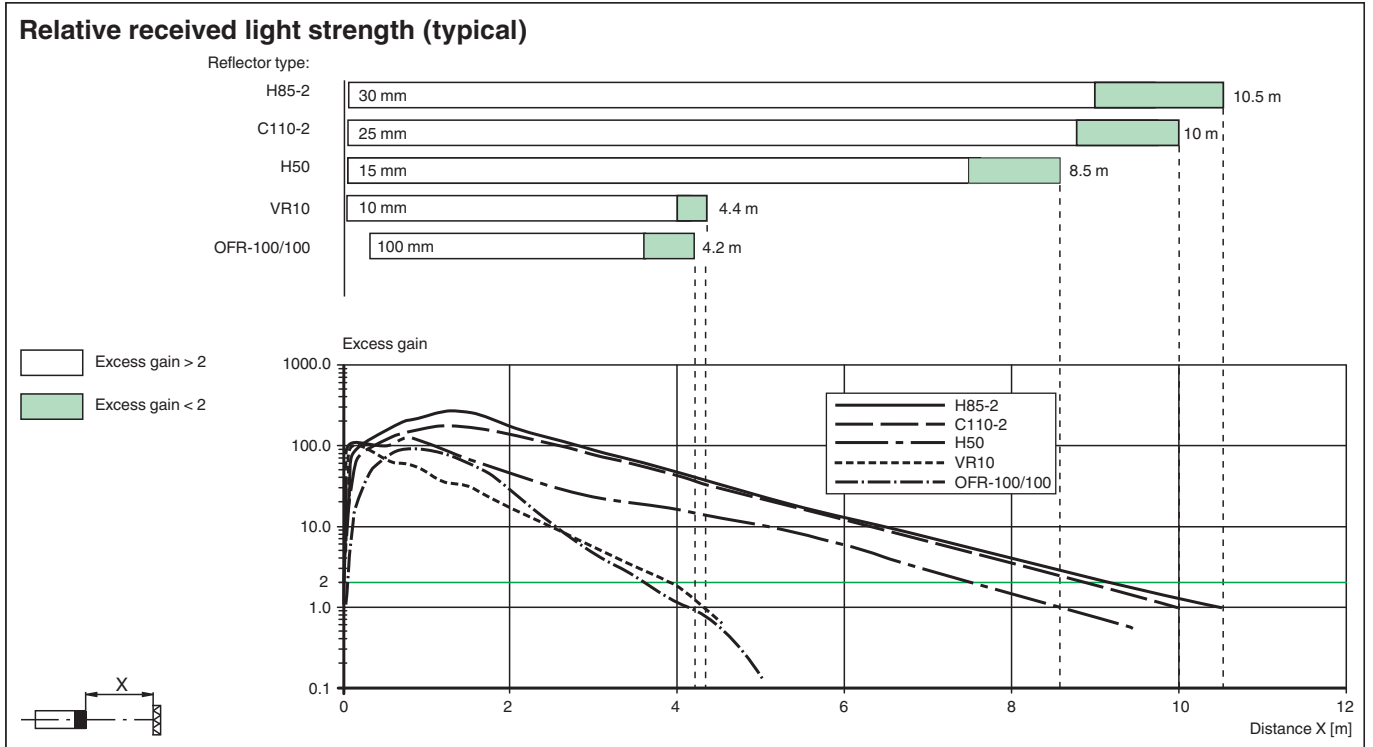
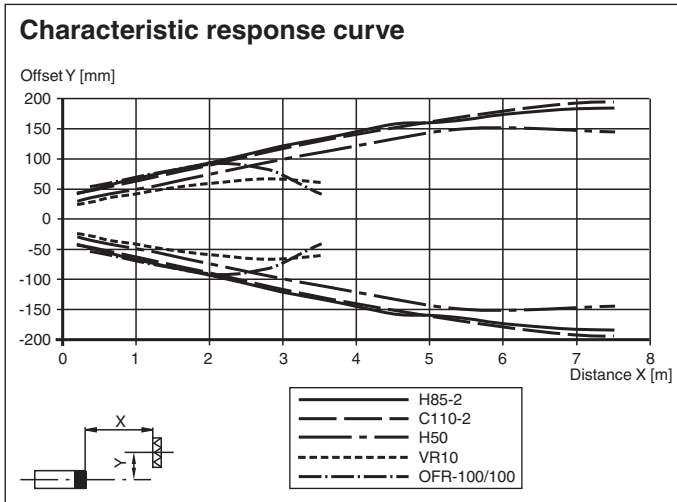







Accessories

	V3-WM-2M-PUR	Female cordset single-ended M8 angled A-coded, 3-pin, PUR cable grey
	OMH-R101	Mounting Clamp
	OMH-R101-Front	Mounting Clamp
	OMH-4.1	Mounting Clamp
	OMH-ML6	Mounting bracket

Release date: 2023-03-28 Date of issue: 2023-03-28 Filename: 267075-100429_eng.pdf

Accessories

	OMH-ML6-U	Mounting bracket
	OMH-ML6-Z	Mounting bracket
	OFR-100/100	Reflective tape 100 mm x 100 mm
	REF-H33	Reflector with screw fixing
	REF-H50	Reflector, rectangular 51 mm x 61 mm, mounting holes, fixing strap
	REF-H85-2	Reflector, rectangular 84.5 mm x 84.5 mm, mounting holes
	REF-VR10	Reflector, rectangular 60 mm x 19 mm, mounting holes