



## Retroreflective sensor

### OBR10M-R100-2EP-IO-V31-1R-IR



- Miniature design with versatile mounting options
- Extended temperature range  
-40 °C ... 60 °C
- High degree of protection IP69K
- IO-Link interface for service and process data

## Retroreflective sensor



## Function

The R100 series miniature optical sensors are the first devices of their kind to offer an end-to-end solution in a small single standard design — from thru-beam sensor through to a distance measurement device. As a result of this design, the sensors are able to perform practically all standard automation tasks.

The entire series enables sensors to communicate via IO-Link.

The DuraBeam laser sensors are durable and can be used in the same way as a standard sensor.

The use of Multi Pixel Technology gives the standard sensors a high level of flexibility and enables them to adapt more effectively to their operating environment.

## Dimensions

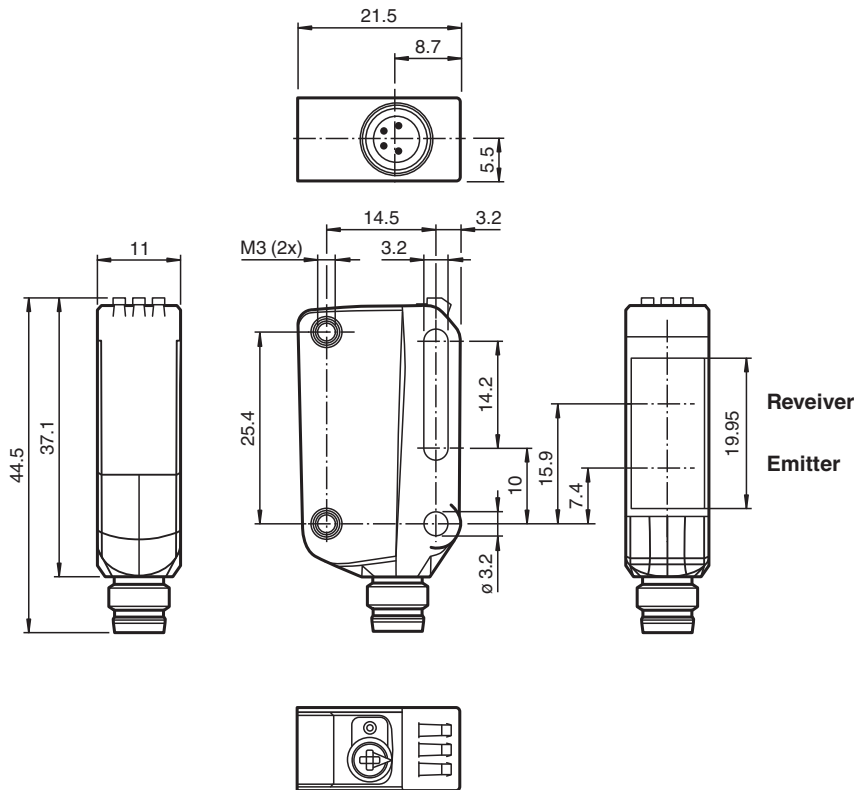

Release date: 2023-03-28 Date of issue: 2023-03-28 Filename: 267075-100430\_eng.pdf

## Technical Data

General specifications		
Effective detection range		0.35 ... 10 m , At close range, switching to white target objects occurs
Reflector distance		0.5 ... 10 m
Threshold detection range		11 m
Reference target		H85-2 reflector
Light source		LED
Light type		modulated infrared light 850 nm
LED risk group labelling		exempt group
Polarization filter		no
Diameter of the light spot		approx. 100 mm at a distance of 1 m
Opening angle		5.4 °
Ambient light limit		EN 60947-5-2
Functional safety related parameters		
MTTF <sub>d</sub>		724 a
Mission Time (T <sub>M</sub> )		20 a
Diagnostic Coverage (DC)		0 %
Indicators/operating means		
Operation indicator		LED green: constantly on - power on flashing (4Hz) - short circuit flashing with short break (1 Hz) - IO-Link mode
Function indicator		Yellow LED: Permanently lit - light path clear Permanently off - object detected Flashing (4 Hz) - insufficient operating reserve
Control elements		Light-on/dark-on changeover switch
Control elements		sensitivity adjustment
Parameterization indicator		IO link communication: green LED goes out briefly (1 Hz)
Electrical specifications		
Operating voltage	U <sub>B</sub>	10 ... 30 V DC
Ripple		max. 10 %
No-load supply current	I <sub>0</sub>	< 25 mA at 24 V supply voltage
Protection class		III
Interface		
Interface type		IO-Link ( via C/Q = pin 4 )
IO-Link revision		1.1
Device ID		0x11020D (1114637)
Transfer rate		COM2 (38.4 kBit/s)
Min. cycle time		2.3 ms
Process data width		Process data input 2 Bit Process data output 2 Bit
SIO mode support		yes
Compatible master port type		A
Output		
Switching type		The switching type of the sensor is adjustable. The default setting is: C/Q - Pin4: NPN normally open / dark-on, PNP normally closed / light-on, IO-Link /Q - Pin2: NPN normally closed / light-on, PNP normally open / dark-on
Signal output		2 push-pull (4 in 1) outputs, short-circuit protected, reverse polarity protected, overvoltage protected
Switching voltage		max. 30 V DC
Switching current		max. 100 mA , resistive load
Usage category		DC-12 and DC-13
Voltage drop	U <sub>d</sub>	≤ 1.5 V DC
Switching frequency	f	1000 Hz
Response time		0.5 ms
Conformity		
Communication interface		IEC 61131-9

Release date: 2023-03-28 Date of issue: 2023-03-28 Filename: 267075-100430\_eng.pdf

## Technical Data

Product standard	EN 60947-5-2
<b>Approvals and certificates</b>	
UL approval	E87056 , cULus Listed , class 2 power supply , type rating 1
<b>Ambient conditions</b>	
Ambient temperature	-40 ... 60 °C (-40 ... 140 °F)
Storage temperature	-40 ... 70 °C (-40 ... 158 °F)
<b>Mechanical specifications</b>	
Housing width	11 mm
Housing height	44.5 mm
Housing depth	21.5 mm
Degree of protection	IP67 / IP69 / IP69K
Connection	M8 x 1 connector, 4-pin
<b>Material</b>	
Housing	PC (Polycarbonate)
Optical face	PMMA
Mass	approx. 10 g

## Connection

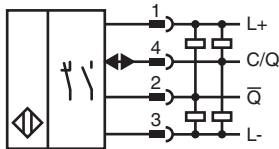

## Connection Assignment



Wire colors in accordance with EN 60947-5-2

1	BN	(brown)
2	WH	(white)
3	BU	(blue)
4	BK	(black)

Assembly

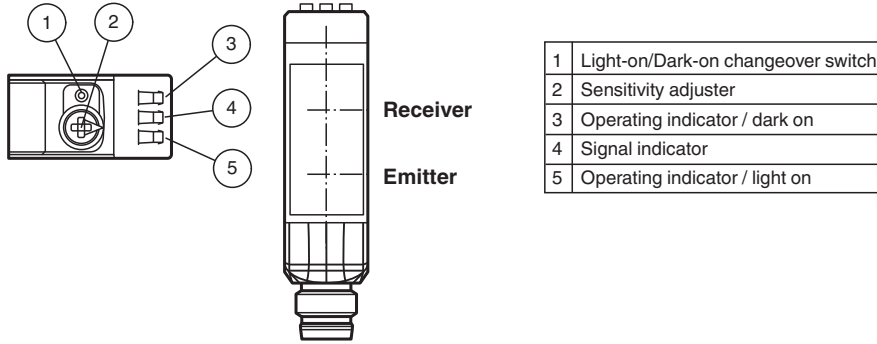





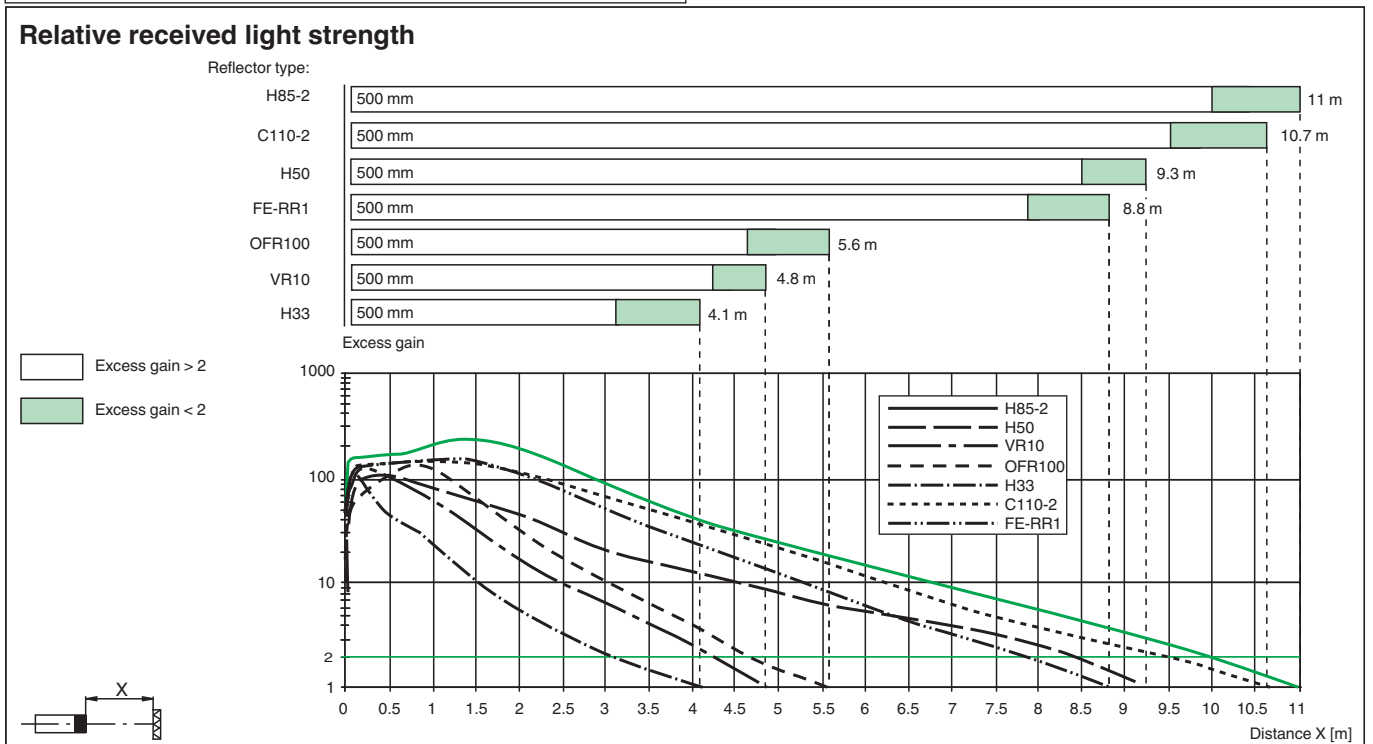
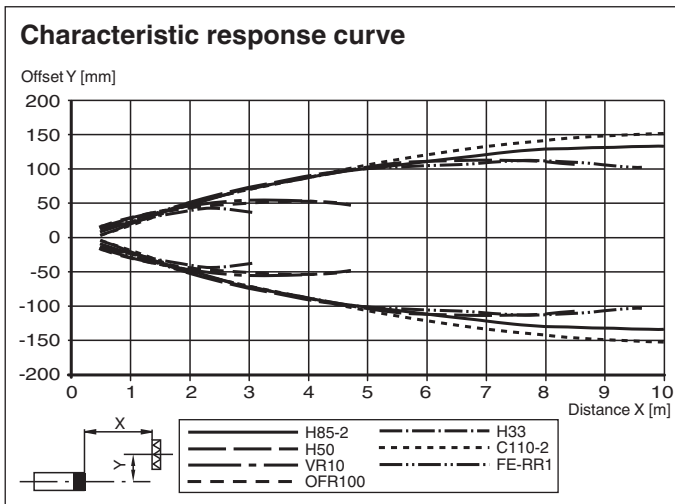















1	Light-on/Dark-on changeover switch
2	Sensitivity adjuster
3	Operating indicator / dark on
4	Signal indicator
5	Operating indicator / light on

Characteristic Curve







Release date: 2023-03-28 Date of issue: 2023-03-28 Filename: 267075-100430\_eng.pdf

## Accessories

	<b>OMH-ML100-09</b>	Mounting aid for round steel $\varnothing$ 12 mm or sheet 1.5 mm ... 3 mm
	<b>REF-H33</b>	Reflector with screw fixing
	<b>REF-H85-2</b>	Reflector, rectangular 84.5 mm x 84.5 mm, mounting holes
	<b>REF-H50</b>	Reflector, rectangular 51 mm x 61 mm, mounting holes, fixing strap
	<b>REF-VR10</b>	Reflector, rectangular 60 mm x 19 mm, mounting holes
	<b>REF-MH82</b>	Reflector with Micro-structure, rectangular 82 mm x 60 mm, mounting holes
	<b>REF-MH20</b>	Reflector with Micro-structure, rectangular 32 mm x 20 mm, mounting holes
	<b>OFR-100/100</b>	Reflective tape 100 mm x 100 mm
	<b>OMH-R10X-01</b>	Mounting bracket
	<b>OMH-R10X-02</b>	Mounting bracket
	<b>OMH-R10X-04</b>	Mounting bracket
	<b>OMH-R10X-10</b>	Mounting bracket
	<b>OMH-ML100-03</b>	Mounting aid for round steel $\varnothing$ 12 mm or sheet 1.5 mm ... 3 mm
	<b>OMH-ML100-031</b>	Mounting aid for round steel $\varnothing$ 10 ... 14 mm or sheet 1 mm ... 5 mm
	<b>V31-GM-2M-PUR</b>	Female cordset single-ended M8 straight A-coded, 4-pin, PUR cable grey
	<b>V31-WM-2M-PUR</b>	Female cordset single-ended M8 angled A-coded, 4-pin, PUR cable grey
	<b>ICE2-8IOL-G65L-V1D</b>	EtherNet/IP IO-Link master with 8 inputs/outputs
	<b>ICE3-8IOL-G65L-V1D</b>	PROFINET IO IO-Link master with 8 inputs/outputs
	<b>ICE1-8IOL-G30L-V1D</b>	Ethernet IO-Link module with 8 inputs/outputs
	<b>ICE1-8IOL-G60L-V1D</b>	Ethernet IO-Link module with 8 inputs/outputs

## Accessories

	<b>ICE2-8IOL-K45P-RJ45</b>	EtherNet/IP IO-Link master with 8 inputs/outputs, DIN rail, push-in connectors
	<b>ICE2-8IOL-K45S-RJ45</b>	EtherNet/IP IO-Link master with 8 inputs/outputs, DIN rail, screw terminal
	<b>ICE3-8IOL-K45P-RJ45</b>	PROFINET IO IO-Link master with 8 inputs/outputs, DIN rail, push-in terminals
	<b>ICE3-8IOL-K45S-RJ45</b>	PROFINET IO IO-Link master with 8 inputs/outputs, DIN rail, screw terminal
	<b>IO-Link-Master02-USB</b>	IO-Link master, supply via USB port or separate power supply, LED indicators, M12 plug for sensor connection

## Configuration



- 1 - Light-on / dark-on changeover switch
- 2 - Sensing range / sensitivity adjuster
- 3 - Operating indicator / dark on
- 4 - Signal indicator
- 5 - Operating indicator / light on

To unlock the adjustment functions turn the sensing range /sensitivity adjuster for more than 180 degrees.

### Sensing Range / Sensitivity

Turn sensing range / sensitivity adjuster clockwise to increase sensing range / sensitivity.

Turn sensing range / sensitivity adjuster counter clockwise to decrease sensing range / sensitivity.

If the end of the adjustment range is reached, the signal indicator starts flashing with 8 Hz.

### Light-on / Dark-on Configuration

Press the light-on / dark-on changeover switch for more than 1 second (less than 4 seconds). The light-on / dark-on mode changes and the operating indicators are activated accordingly.

If you press the light-on / dark-on changeover switch for more than 4 seconds, the light-on /dark-on mode changes back to the original setting. On release of the light-on / dark-on changeover switch the current state is activated.

### Restore Factory Settings

Press the light-on / dark-on changeover switch for more than 10 seconds (less than 30 seconds) until all LEDs turn off. On release of the light-on / dark-on changeover switch the signal indicator turns on. After 5 seconds the sensor resumes operation with factory default settings.

After 5 minutes of inactivity the sensing range / sensitivity adjustment is locked. In order to reactivate the sensing range / sensitivity adjustment, turn the sensing range /sensitivity adjuster for more than 180 degrees.