



Triangulation sensor (BGS) OBT350-R100-2EP-IO-0,3M-V1-IR



- Miniature design with versatile mounting options
- Best background suppressor in its class
- Precision object detection, almost irrespective of the color
- Extended temperature range
-40 °C ... 60 °C
- High degree of protection IP69K
- IO-Link interface for service and process data

Triangulation sensor with background suppression



Function

The R100 series miniature optical sensors are the first devices of their kind to offer an end-to-end solution in a small single standard design — from thru-beam sensor through to a distance measurement device. As a result of this design, the sensors are able to perform practically all standard automation tasks.

The entire series enables sensors to communicate via IO-Link.

The DuraBeam laser sensors are durable and can be used in the same way as a standard sensor.

The use of Multi Pixel Technology gives the standard sensors a high level of flexibility and enables them to adapt more effectively to their operating environment.

Dimensions

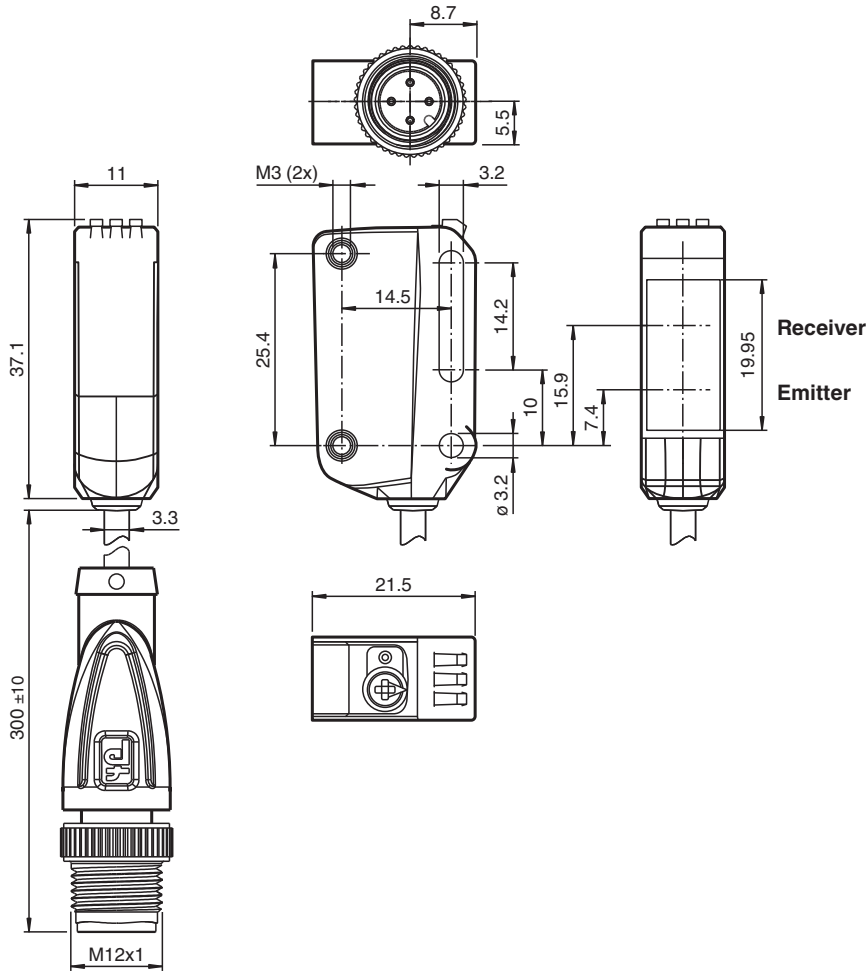

Technical Data

| General specifications | |
|--------------------------------------|---|
| Detection range | 5 ... 350 mm |
| Detection range min. | 5 ... 25 mm |
| Detection range max. | 5 ... 350 mm |
| Adjustment range | 25 ... 350 mm |
| Reference target | standard white, 100 mm x 100 mm |
| Light source | LED |
| Light type | modulated infrared light 850 nm |
| LED risk group labelling | exempt group |
| Black-white difference (6%/90%) | < 15 % at 350 mm |
| Diameter of the light spot | approx. 26 mm at a distance of 350 mm |
| Opening angle | approx. 4 ° |
| Ambient light limit | EN 60947-5-2 : 40000 Lux |
| Functional safety related parameters | |
| MTTF _d | 600 a |
| Mission Time (T _M) | 20 a |
| Diagnostic Coverage (DC) | 0 % |
| Indicators/operating means | |
| Operation indicator | LED green: constantly on - power on flashing (4Hz) - short circuit flashing with short break (1 Hz) - IO-Link mode |

Release date: 2023-03-28 Date of issue: 2023-03-28 Filename: 267075-100497_eng.pdf

Technical Data

| | | |
|-----------------------------------|-------|---|
| Function indicator | | LED yellow: constantly on - object detected constantly off - object not detected |
| Control elements | | Light-on/dark-on changeover switch |
| Control elements | | Sensing range adjuster |
| Electrical specifications | | |
| Operating voltage | U_B | 10 ... 30 V DC |
| Ripple | | max. 10 % |
| No-load supply current | I_0 | < 25 mA at 24 V supply voltage |
| Protection class | | III |
| Interface | | |
| Interface type | | IO-Link (via C/Q = pin 4) |
| IO-Link revision | | 1.1 |
| Device profile | | Smart Sensor |
| Device ID | | 0x11060A (1115658) |
| Transfer rate | | COM2 (38.4 kBit/s) |
| Min. cycle time | | 2.3 ms |
| Process data width | | Process data input 1 Bit Process data output 2 Bit |
| SIO mode support | | yes |
| Compatible master port type | | A |
| Output | | |
| Switching type | | The switching type of the sensor is adjustable. The default setting is: C/Q - Pin4: NPN normally open / light-on, PNP normally closed / dark-on, IO-Link /Q - Pin2: NPN normally closed / dark-on, PNP normally open / light-on |
| Signal output | | 2 push-pull (4 in 1) outputs, short-circuit protected, reverse polarity protected, overvoltage protected |
| Switching voltage | | max. 30 V DC |
| Switching current | | max. 100 mA , resistive load |
| Usage category | | DC-12 and DC-13 |
| Voltage drop | U_d | ≤ 1.5 V DC |
| Switching frequency | f | 500 Hz |
| Response time | | 1 ms |
| Conformity | | |
| Communication interface | | IEC 61131-9 |
| Product standard | | EN 60947-5-2 |
| Approvals and certificates | | |
| UL approval | | E87056 , cULus Listed , class 2 power supply , type rating 1 |
| Ambient conditions | | |
| Ambient temperature | | -40 ... 60 °C (-40 ... 140 °F) |
| Storage temperature | | -40 ... 70 °C (-40 ... 158 °F) |
| Mechanical specifications | | |
| Housing width | | 11 mm |
| Housing height | | 37.1 mm |
| Housing depth | | 21.5 mm |
| Degree of protection | | IP67 / IP69 / IP69K |
| Connection | | 300 mm fixed cable with M12 x 1, 4-pin connector |
| Material | | |
| Housing | | PC (Polycarbonate) |
| Optical face | | PMMA |
| Mass | | approx. 10 g |

Connection



Connection Assignment



Wire colors in accordance with EN 60947-5-2

- 1 | BN (brown)
- 2 | WH (white)
- 3 | BU (blue)
- 4 | BK (black)

Assembly

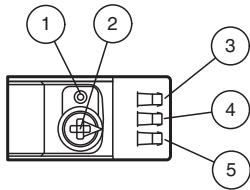

| | |
|---|--------------------------------------|
| 1 | Light-on / dark-on changeover switch |
| 2 | Sensing range adjuster |
| 3 | Operating indicator / dark on |
| 4 | Signal indicator |
| 5 | Operating indicator / light on |

Characteristic Curve

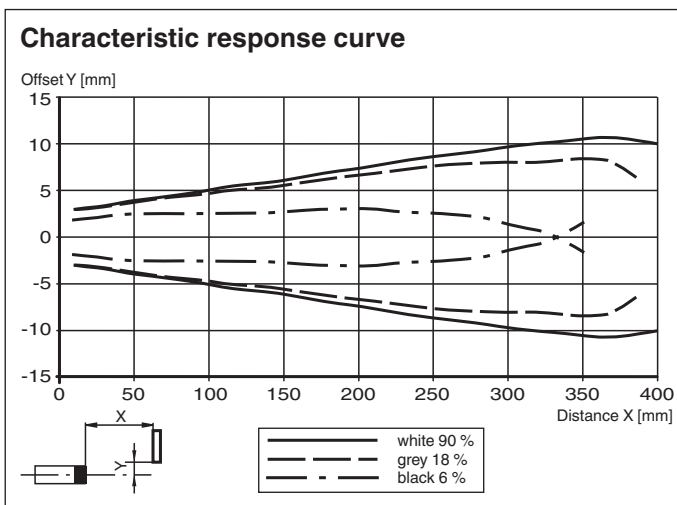

Release date: 2023-03-28 Date of issue: 2023-03-28 Filename: 267075-100497_eng.pdf

Characteristic Curve

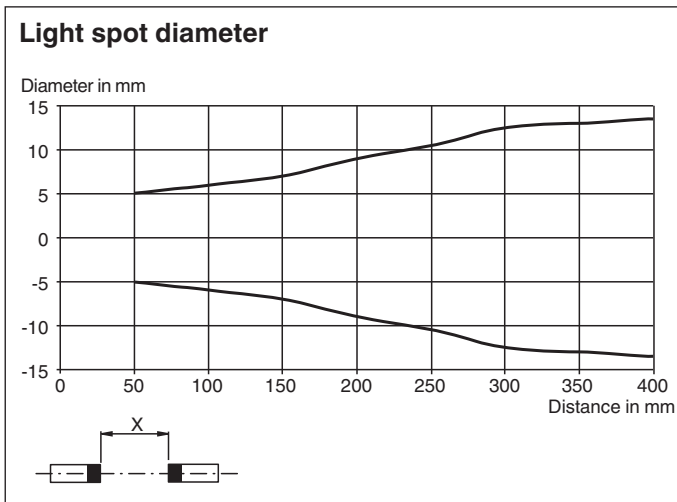
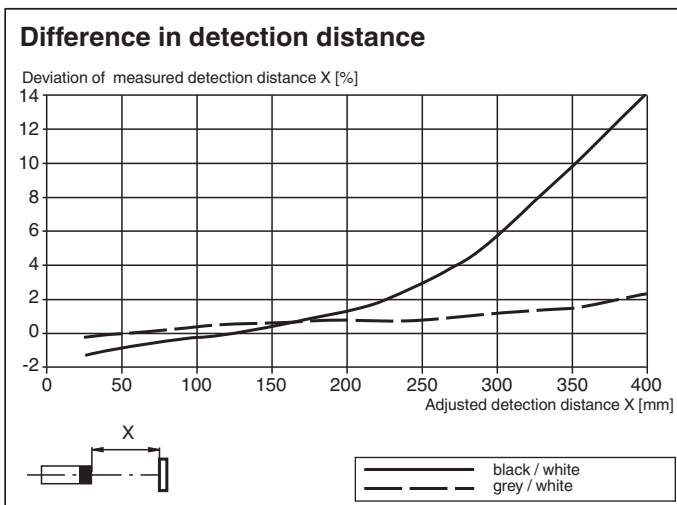
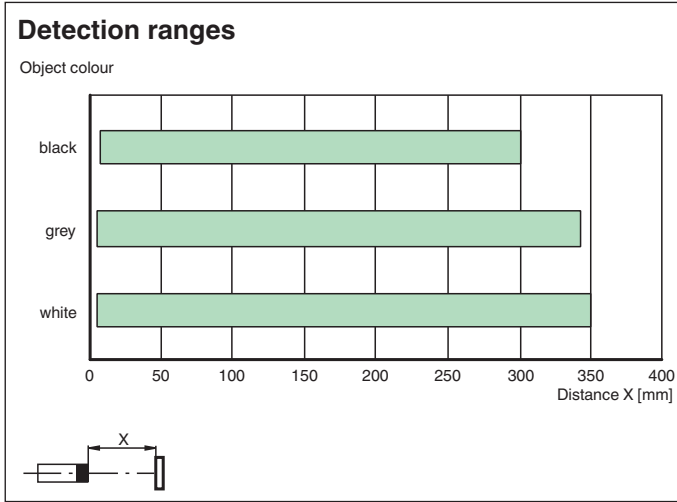









Accessories

| | | |
|--|----------------------|--|
| | V31-GM-2M-PUR | Female cordset single-ended M8 straight A-coded, 4-pin, PUR cable grey |
| | V31-WM-2M-PUR | Female cordset single-ended M8 angled A-coded, 4-pin, PUR cable grey |

Release date: 2023-03-28 Date of issue: 2023-03-28 Filename: 267075-100497_eng.pdf

Accessories

| | | |
|---|-----------------------------|--|
|  | ICE2-8IOL-G65L-V1D | EtherNet/IP IO-Link master with 8 inputs/outputs |
|  | ICE3-8IOL-G65L-V1D | PROFINET IO IO-Link master with 8 inputs/outputs |
|  | ICE1-8IOL-G30L-V1D | Ethernet IO-Link module with 8 inputs/outputs |
|  | ICE1-8IOL-G60L-V1D | Ethernet IO-Link module with 8 inputs/outputs |
|  | ICE2-8IOL-K45P-RJ45 | EtherNet/IP IO-Link master with 8 inputs/outputs, DIN rail, push-in connectors |
|  | ICE2-8IOL-K45S-RJ45 | EtherNet/IP IO-Link master with 8 inputs/outputs, DIN rail, screw terminal |
|  | ICE3-8IOL-K45P-RJ45 | PROFINET IO IO-Link master with 8 inputs/outputs, DIN rail, push-in terminals |
|  | ICE3-8IOL-K45S-RJ45 | PROFINET IO IO-Link master with 8 inputs/outputs, DIN rail, screw terminal |
|  | IO-Link-Master02-USB | IO-Link master, supply via USB port or separate power supply, LED indicators, M12 plug for sensor connection |

Configuration

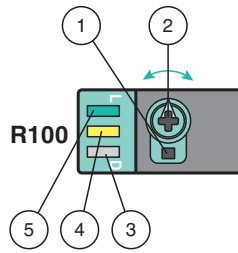

- 1 - Light-on / dark-on changeover switch
- 2 - Sensing range / sensitivity adjuster
- 3 - Operating indicator / dark on
- 4 - Signal indicator
- 5 - Operating indicator / light on

To unlock the adjustment functions turn the sensing range /sensitivity adjuster for more than 180 degrees.

Sensing Range / Sensitivity

Turn sensing range / sensitivity adjuster clockwise to increase sensing range / sensitivity.

Turn sensing range / sensitivity adjuster counter clockwise to decrease sensing range / sensitivity.

If the end of the adjustment range is reached, the signal indicator starts flashing with 8 Hz.

Light-on / Dark-on Configuration

Press the light-on / dark-on changeover switch for more than 1 second (less than 4 seconds). The light-on / dark-on mode changes and the operating indicators are activated accordingly.

If you press the light-on / dark-on changeover switch for more than 4 seconds, the light-on /dark-on mode changes back to the original setting. On release of the light-on / dark-on changeover switch the current state is activated.

Restore Factory Settings

Press the light-on / dark-on changeover switch for more than 10 seconds (less than 30 seconds) until all LEDs turn off. On release of the light-on / dark-on changeover switch the signal indicator turns on. After 5 seconds the sensor resumes operation with factory default settings.

After 5 minutes of inactivity the sensing range / sensitivity adjustment is locked. In order to reactivate the sensing range / sensitivity adjustment, turn the sensing range /sensitivity adjuster for more than 180 degrees.