

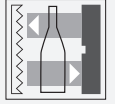

Retroreflective sensor (glass)

OBG5000-R100-E5-V3



- Miniature design with versatile mounting options
- Detects transparent objects, i.e., clear glass, PET and transparent films
- Two machines in one: clear object detection or reflection operating mode with long range
- High degree of protection IP69K

Retroreflective sensor with polarization filter for clear object detection



Function

The R100 series miniature optical sensors are the first devices of their kind to offer an end-to-end solution in a small single standard design — from thru-beam sensor through to a distance measurement device. As a result of this design, the sensors are able to perform practically all standard automation tasks.

The entire series enables sensors to communicate via IO-Link.

The DuraBeam laser sensors are durable and can be used in the same way as a standard sensor.

The use of Multi Pixel Technology gives the standard sensors a high level of flexibility and enables them to adapt more effectively to their operating environment.

Dimensions

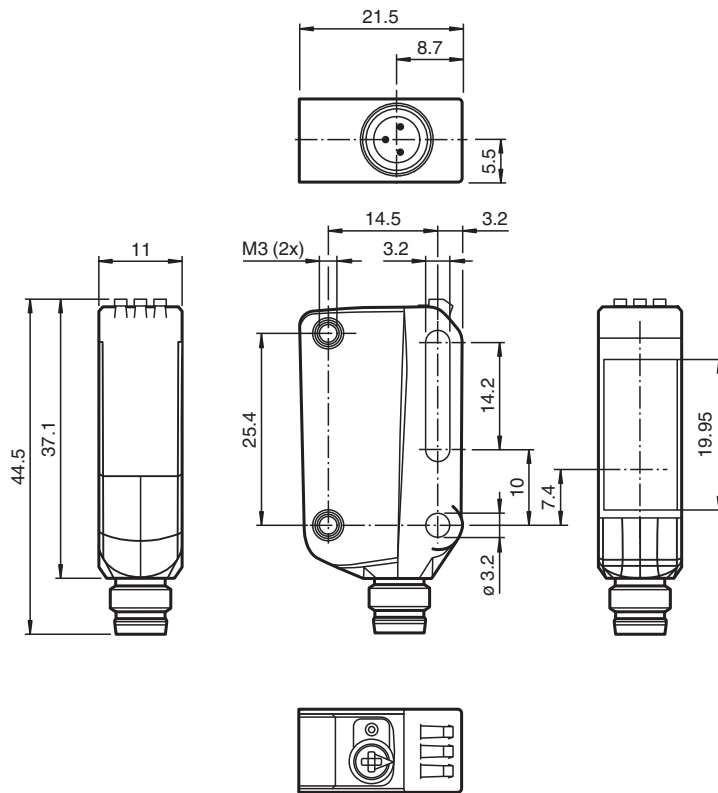

Technical Data

General specifications

Effective detection range	0 ... 3.5 m in TEACH mode ; 0 ... 5 m at switch position "N"
Reflector distance	0 ... 3.5 m in TEACH mode ; 0 ... 5 m at switch position "N"
Threshold detection range	6 m
Reference target	H85-2 reflector
Light source	LED
Light type	modulated visible red light
LED risk group labelling	exempt group
Diameter of the light spot	approx. 170 mm at a distance of 3.5 m
Opening angle	approx. 5 °
Ambient light limit	EN 60947-5-2

Functional safety related parameters

MTTF _d	600 a
Mission Time (T _M)	20 a
Diagnostic Coverage (DC)	0 %

Indicators/operating means

Operation indicator	Green LED: Permanently lit - power on Flashing (4 Hz) - short circuit
Function indicator	Yellow LED: Permanently lit - light path clear Permanently off - object detected Flashing (4 Hz) - insufficient operating reserve
Control elements	Teach-In key

Technical Data

Control elements	5-step rotary switch for operating modes selection	
Contrast detection levels		10 % - clean, water filled PET bottles 18 % - clear glass bottles 40 % - colored glass or opaque materials Adjustable via rotary switch
Electrical specifications		
Operating voltage	U_B	10 ... 30 V DC
Ripple		max. 10 %
No-load supply current	I_0	< 25 mA at 24 V supply voltage
Protection class		III
Output		
Switching type	The switching type of the sensor is adjustable. The default setting is: Q - Pin4: PNP normally open / dark-on	
Signal output		1 PNP, short-circuit protected, reverse polarity protected
Switching voltage		max. 30 V DC
Switching current		max. 100 mA , resistive load
Usage category		DC-12 and DC-13
Voltage drop	U_d	≤ 1.5 V DC
Switching frequency	f	500 Hz
Response time		1 ms
Conformity		
Communication interface		IEC 61131-9
Product standard		EN 60947-5-2
Approvals and certificates		
UL approval	E87056 , cULus Listed , class 2 power supply , type rating 1	
Ambient conditions		
Ambient temperature	-20 ... 60 °C (-4 ... 140 °F)	
Storage temperature	-40 ... 70 °C (-40 ... 158 °F)	
Mechanical specifications		
Degree of protection	IP67 / IP69 / IP69K	
Connection	M8 x 1 connector, 3-pin	
Material		
Housing	PC (Polycarbonate)	
Optical face	PMMA	
Mass	approx. 10 g	
Dimensions		
Height	44.5 mm	
Width	11 mm	
Depth	21.5 mm	

Connection Assignment

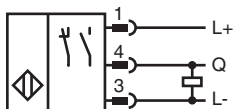

Connection Assignment



Wire colors in accordance with EN 60947-5-2

1	BN	(brown)
3	BU	(blue)
4	BK	(black)

Assembly

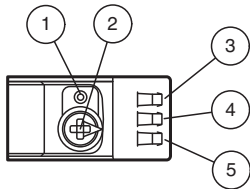

1	Teach-in button
2	Mode rotary switch
3	Operating indicator / dark on
4	Signal indicator
5	Operating indicator / light on

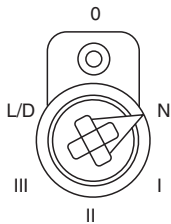

N	Normal mode
I	10 % contrast detection
II	18 % contrast detection
III	40 % contrast detection
L/D	Switching type
0	Keylock

Characteristic Curve

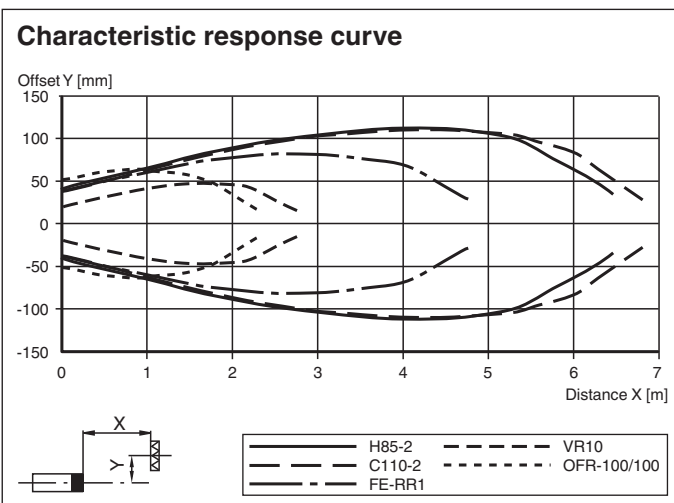

Release date: 2025-07-02 Date of issue: 2025-07-02 Filename: 267075-100632_eng.pdf

Characteristic Curve

Relative received light strength in switch position "N"

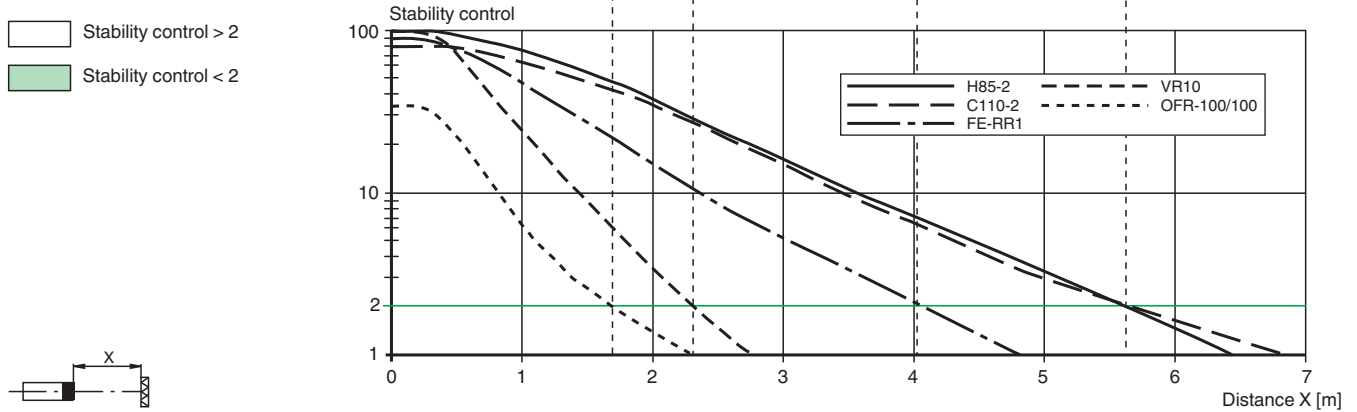
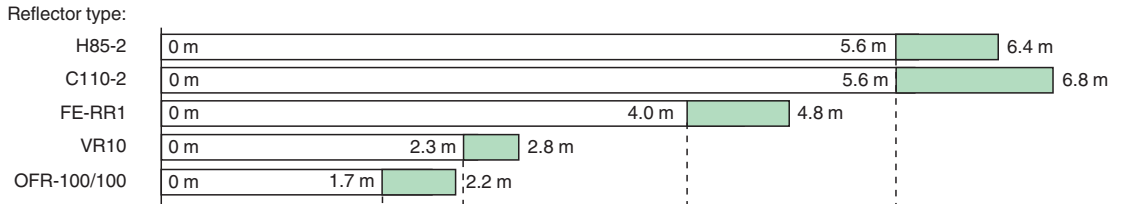

Commissioning

Teach-in

Use the rotary switch to select the required operating mode: Normal mode (N) or contrast level I – III.
 To teach in a threshold or activate an operating mode, press the "TI" button until the yellow and green LEDs flash in phase (approx. 1 s). Release the "TI" button. Teach-in starts.
 Successful teach-in is indicated by alternating flashing (2.5 Hz) of the yellow and green LEDs. The sensor will now operate in the selected operating mode with the taught-in threshold.
 An unsuccessful teach-in is indicated by rapidly alternating flashing (8 Hz) of the yellow and green LEDs. After an unsuccessful teach-in, the sensor continues to operate with the previous valid setting after the relevant visual fault signal is issued.
 Every taught-in switching threshold can be re-taught (overwritten) by pressing the "TI" button again.
 Note: To ensure that the device functions reliably in Contrast mode, the device must be powered on at least 30 s before teach-in.

Setting the Device to Maximum Sensitivity

1. Use the rotary switch to select the Normal mode (N) position.
2. Press the "TI" button for > 4 s. The yellow and green LEDs will go out.
3. Release the "TI" button.

The settings will be reset to maximum sensitivity. After successfully resetting, the yellow and green LEDs will flash alternately (2.5 Hz).

Switching between light on/dark on

1. Use the rotary switch to select the light on/dark on (L/D) position.
2. Press the "TI" button for > 1 s. The respective operating indicator LED (L/D) will illuminate green and the switching type will change.
3. To reset the switching type, press the "TI" button for > 4 s. The respective operating indicator LED (L/D) will illuminate green and the operating indicator will be reset to the most recently active switching type.

Reset to Default Settings

1. Use the rotary switch to select the O position.
2. Press the "TI" button for > 10 s. The yellow and the green LEDs will both switch off.
3. Release the "TI" button. The yellow LED is on. After resetting, the sensor will operate with the following default settings:
 - Normal mode (N)
 - Maximum sensitivity adjustment
 - Dark on
 - Pin 2 (white core): antivalent switching output

Release date: 2025-07-02 Date of issue: 2025-07-02 Filename: 267075-100632_eng.pdf