

# Termination Board

## HiCTB16-HIM-RAC-SP-AO1601

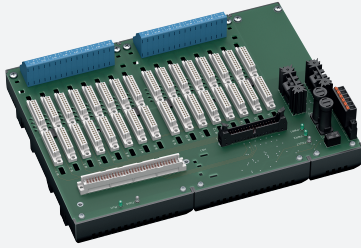

- System board for HIMA, HIMax
- For 16-channel card X-AO 1601 (AO, single mode)
- 16-channel card X-AO 1601 (AO, redundant mode on request)
- For 16 modules
- Recommended module: HiC2031 (AO)
- 24 V DC supply
- Hazardous area: spring terminals, blue
- Non-hazardous area: HIMA system connector, 96-pin



### Function

The function of the termination board and the connector pin assignment is exactly fitted to the requirements of the HIMA HIMax system. The signal is output to the safety instrumented system via the system connector. Information about a missing supply voltage of the isolated barriers is available for the system as a volt-free contact. Wiring faults from the field side will be reported via the same relay contact, if this function is supported by the isolated barriers. The termination board has a robust glass fiber reinforced plastic housing. The termination board is mounted in the switch cabinet on a 35 mm DIN mounting rail according to EN 60175.

### Connection

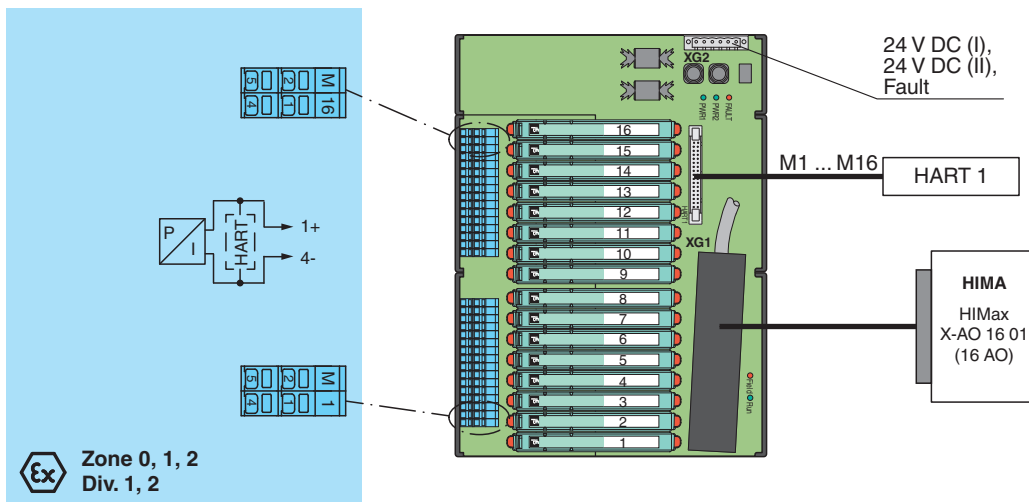

### Technical Data

| Supply                      |  |
|-----------------------------|--|
| Connection                  | XG2: terminals 1, 3 (+); 2, 4 (-)  |
| Nominal voltage             | 24 V DC , in consideration of rated voltage of used isolators                            |
| Voltage drop                | 0.9 V , voltage drop across the series diode on the termination board must be considered |
| Ripple                      | ≤ 10 %   |
| Fusing                      | 4 A , in each case for 16 modules  |
| Power dissipation           | ≤ 500 mW , without modules   |
| Reverse polarity protection | yes  |
| Redundancy                  |  |
| Supply                      | Redundancy available. The supply for the isolators is decoupled, monitored and fused.    |

Release date: 2023-02-20 Date of issue: 2023-02-20 Filename: 269898\_eng.pdf









## Technical Data

|  |  |
|--|--|
| <b>Fault indication output</b>                                 |  |
| Connection   | YG2: terminals 5, 6  |
| Output type  | volt-free contact  |
| Switch behaviour   | no fault: relay contact closed<br>power supply fault: relay contact open<br>module fault: relay contact open   |
| Contact loading  | 30 V DC, 1 A   |
| <b>Indicators/settings</b>                                     |  |
| Display elements   | LED PWR1 (termination board power supply), green LED<br>LED PWR2 (termination board power supply), green LED<br>LED FAULT (fault indication), red LED<br>- LED lits: power supply fault<br>- LED flashes: module fault<br>LED Run, green LED<br>- The HIMax I/O module is supplied with power and is connected to the Termination Board (FTA) via a system cable.<br>LED Field, red LED<br>- The HIMax I/O module detects faults in the connection between HIMax I/O module and Termination Board (FTA). |
| <b>Directive conformity</b>                                    |  |
| Electromagnetic compatibility                                  |  |
| Directive 2014/30/EU   | EN 61326-1:2013 (industrial locations)   |
| <b>Conformity</b>  |  |
| Electromagnetic compatibility                                  | NE 21:2017<br>For further information see system description.  |
| Degree of protection   | IEC 60529:2001   |
| <b>Ambient conditions</b>                                      |  |
| Ambient temperature  | -20 ... 60 °C (-4 ... 140 °F)  |
| Storage temperature  | -40 ... 85 °C (-40 ... 185 °F)   |
| <b>Mechanical specifications</b>                               |  |
| Degree of protection   | IP20   |
| Connection   |  |
| Field side   | explosion hazardous area: spring terminals , blue  |
| Control side   | non-explosion hazardous area: HIMA system connector, 96-pin  |
| Supply   | pluggable spring terminals , black   |
| Fault output   | pluggable spring terminals , black   |
| Core cross section   | spring terminals: 0.25 ... 1.5 mm <sup>2</sup> (24 ... 16 AWG)   |
| Material   | housing: polycarbonate, 10 % glass fiber reinforced  |
| Mass   | approx. 800 g  |
| Dimensions   | 266 x 200 x 163 mm (10.5 x 7.9 x 6.42 inch) (W x H x D) , depth including module assembly  |
| Mounting   | on 35 mm DIN mounting rail acc. to EN 60715:2001   |
| <b>Data for application in connection with hazardous areas</b> |  |
| EU-type examination certificate                                | CESI 06 ATEX 022   |
| Marking  | ⊕ II (1)G [Ex ia Ga] IIC<br>⊕ II (1)D [Ex ia Da] IIIC<br>⊕ I (M1) [Ex ia Ma] I   |
| Non-hazardous area   |  |
| Maximum safe voltage   | 250 V (Attention! U <sub>m</sub> is no rated voltage.)   |
| Galvanic isolation   |  |
| Field circuit/control circuit                                  | safe electrical isolation acc. to IEC/EN 60079-11, voltage peak value 375 V  |
| Directive conformity   |  |
| Directive 2014/34/EU   | EN IEC 60079-0:2018+AC:2020 , EN 60079-11:2012 , EN 50303:2000   |
| <b>International approvals</b>                                 |  |
| UL approval  | E106378  |
| Control drawing  | 116-0327   |
| IECEX approval   |  |
| IECEX certificate  | IECEX CES 06.0003  |

## Technical Data

|                            |   |
|----------------------------|---|
| IECEX marking              | [Ex ia Ga] IIC<br>[Ex ia Da] IIC<br>[Ex ia Ma] I  |
| <b>General information</b> |   |
| Supplementary information  | Observe the certificates, declarations of conformity, instruction manuals, and manuals where applicable. For information see <a href="http://www.pepperl-fuchs.com">www.pepperl-fuchs.com</a> . |

## Accessories

|   |                                  |  |
|---|----------------------------------|--|
|    | <b>HiATB01-HART-2X16</b>         | HART Communication Board                 |
|    | <b>HiDMux2700</b>                | HART Multiplexer Master                  |
|    | <b>HiALC-HICTB-SET-108</b>       | Label carrier for HiC termination boards |
|    | <b>HiACA-UNI-FLK34-FLK34-0M5</b> | HART Connection Cable, length: 0,5 m     |
|    | <b>HiACA-UNI-FLK34-FLK34-1M0</b> | HART Connection Cable, length: 1 m       |
|    | <b>HiACA-UNI-FLK34-FLK34-2M0</b> | HART Connection Cable, length: 2 m       |
|  | <b>HiACA-UNI-FLK34-FLK34-3M0</b> | HART Connection Cable, length: 3 m       |
|  | <b>HiACA-UNI-FLK34-FLK34-6M0</b> | HART Connection Cable, length: 6 m       |

**Application**

**Typical circuit**

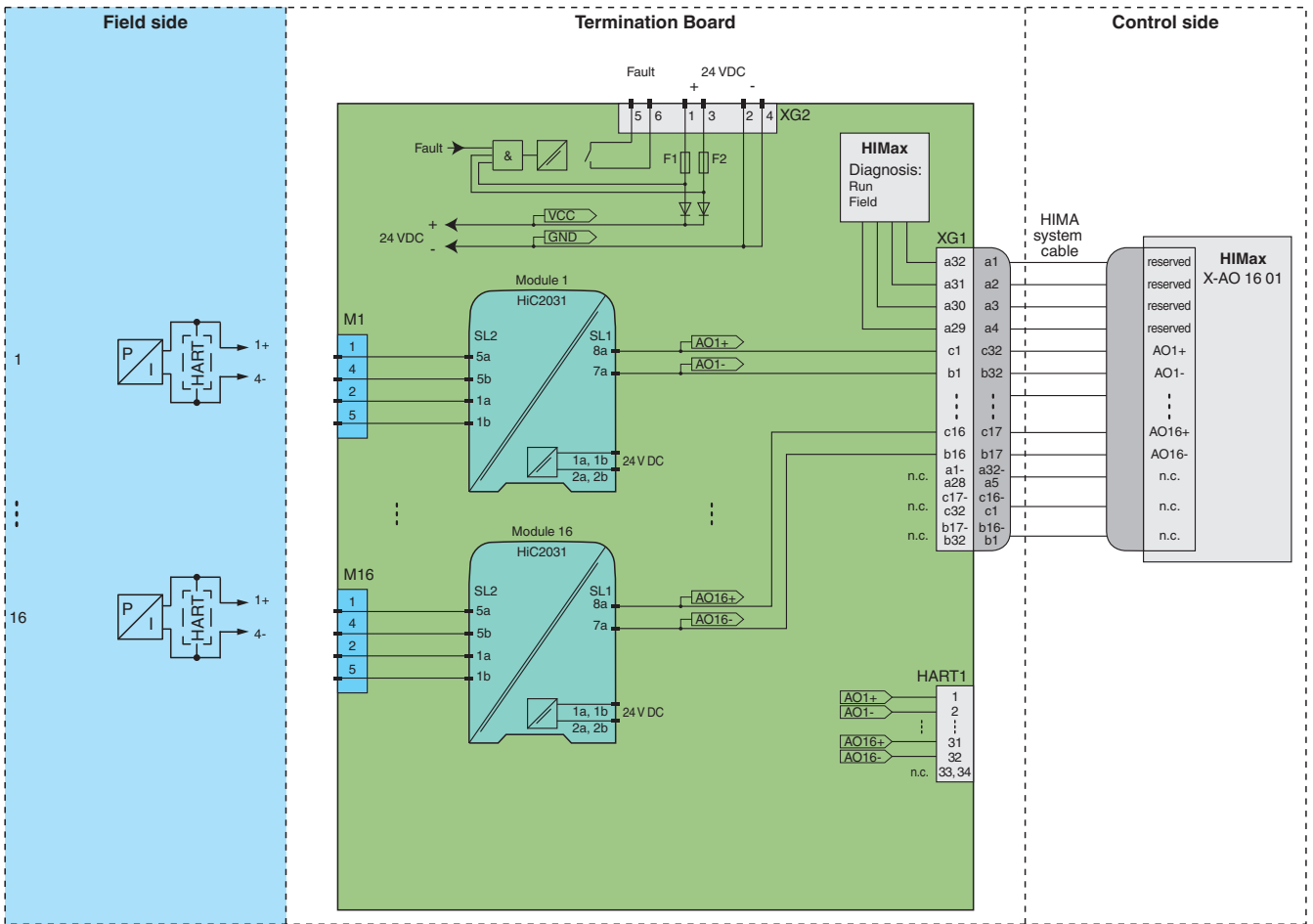

**Module switch settings**

| Type (AO) |               |
|-----------|---------------|
| HiC2031   | not available |

**Card settings**

| Type                      | Mode                          |
|---------------------------|-------------------------------|
| 16-channel card X-AO 1601 | AO, single mode               |
|                           | AO, redundant mode on request |



For exact pin assignment for connection to field side and control side, see the documentation of the isolated barrier.



The pin-out configuration has to be observed. For information see corresponding pin-out table on [www.pepperl-fuchs.com](http://www.pepperl-fuchs.com).

Release date: 2023-02-20 Date of issue: 2023-02-20 Filename: 269898\_eng.pdf