

## Accessories

### DoorScan Cover L1600



- Profile cover for aluminum profile for DoorScan Series
- Length 1600 mm
- for DoorScan design with great profil length

Housing cover DoorScan

## Dimensions

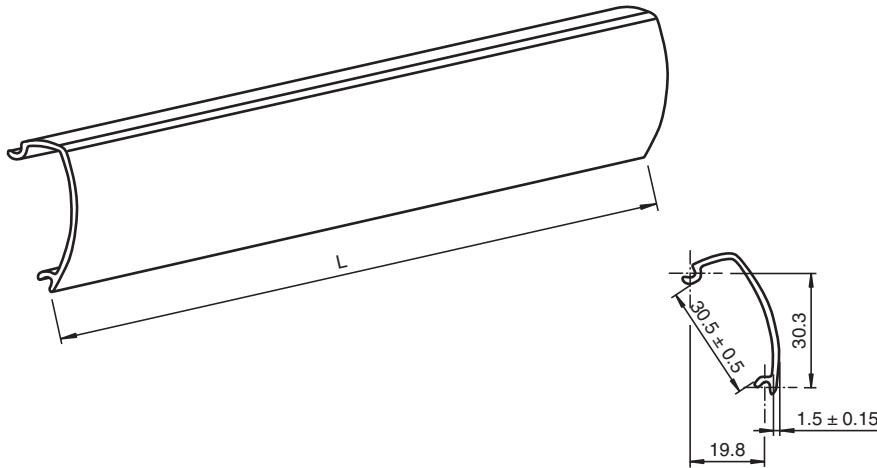

## Technical Data

### Ambient conditions

Ambient temperature -30 ... 60 °C (-22 ... 140 °F)

### Mechanical specifications



Housing length L 1600 mm

Material PMMA

### Suitable series





Series DoorScan®

## Accessories

	<b>DoorScan Weather Cap L1200</b>	All-weather hood for DoorScan® and TopScan series sensing strips
	<b>DoorScan Transfer Loop</b>	Door transition cable to door controller for DoorScan® sensor, including cable sheathing and strain relief
	<b>DoorScan Connection Cable 5p</b>	Connecting cable with 5 plug-in connections for DoorScan®-I/-T/-R modules

Release date: 2020-03-24 Date of issue: 2020-10-08 Filename: 283594\_eng.pdf

## Accessories

	<b>DoorScan Cable BS/BGS</b>	Connecting cable for transition from hinge side to leading edge side
	<b>DoorScan End Caps</b>	End cap set for DoorScan® sensor profile
	<b>DoorScan Relay Module</b>	Replacement/extension sensor module for installation in the DoorScan® and TopScan sensor profile, multifunction interface module
	<b>DoorScan Adapter</b>	Adapter module for installation in the DoorScan® and TopScan sensor profile, multifunction interface module
	<b>TopScan-S Profile L1400</b>	Housing profile TopScan-S