

Retroreflective sensor

MLV12-54-G-7134



- Series of sensors in a widely used standard housing
- Reliable recognition of reflective objects and clear glass
- TEACH-IN switch for setting the contrast detection levels
- Automatic adjustment in case of soiling in contrast detection mode
- High level of stability thanks to the metal housing frame
- Resistant against noise: reliable operation under all conditions

Retroreflective sensor for glass detection, small design, 5.6 m detection range, red light, light/dark on, PNP output, external Teach-In, M12 plug



Dimensions

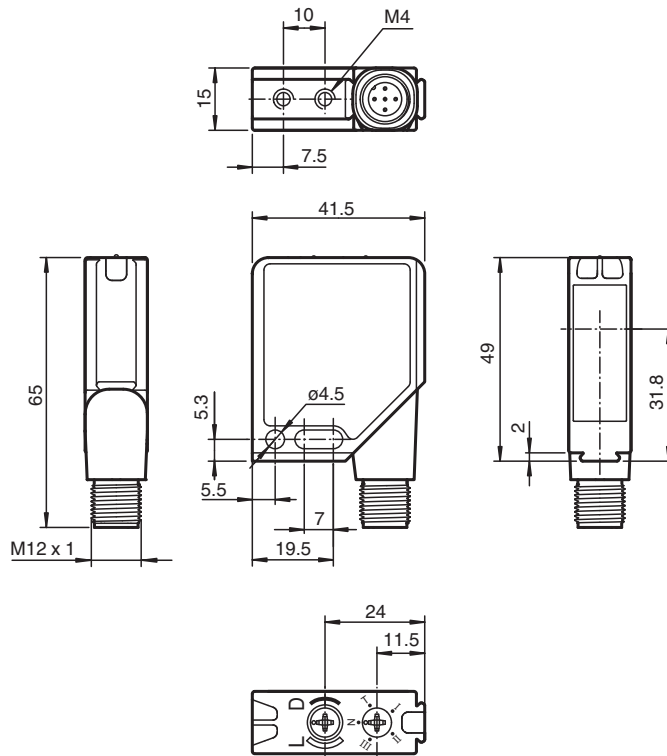

Technical Data

General specifications		
Effective detection range		0 ... 4.2 m
Reflector distance		0 ... 4.2 m
Threshold detection range		5.6 m
Reference target		H85-2 reflector
Light source		LED
Light type		modulated visible red light , 660 nm
Polarization filter		yes
Diameter of the light spot		approx. 110 mm at detection range 4.2 m
Opening angle		1.5 °
Ambient light limit		
Continuous light		40000 Lux
Modulated light		5000 Lux
Functional safety related parameters		
MTTF _d		1000 a
Mission Time (T _M)		20 a
Diagnostic Coverage (DC)		0 %
Indicators/operating means		
Operation indicator		LED green, flashes in case of short-circuit
Function indicator		2 LEDs yellow for switching state, stability control, TEACH-IN and contrast detection mode
Control elements		rotary switch for light/dark, 5-step switch for contrast recognition adjustment
Contrast detection levels		10 % - clean, water filled PET bottles 18 % - clear glass bottles 30 % - films in heated environment adjustable by Teach-In key or external wire
Electrical specifications		
Operating voltage	U _B	10 ... 30 V DC
Ripple		max. 10 %
No-load supply current	I ₀	max. 55 mA
Input		
Function input		Ext. Teach-In input (ET)
Output		
Switching type		light/dark on switchable
Signal output		1 PNP output, short-circuit protected, reverse polarity protected, open collector
Switching voltage		max. 30 V DC
Switching current		max. 0.2 A
Voltage drop	U _d	≤ 2.5 V DC
Switching frequency	f	1000 Hz
Response time		0.5 ms
Conformity		
Product standard		EN 60947-5-2
Compliance with standards and directives		
Standard conformity		
Shock and impact resistance		IEC / EN 60068. half-sine, 40 g in each X, Y and Z directions
Vibration resistance		IEC / EN 60068-2-6. Sinus. 10 -150 Hz, 5 g in each X, Y and Z directions
Approvals and certificates		
Protection class		II, rated voltage ≤ 300 V AC with pollution degree 1-2 according to IEC 60664-1
UL approval		cULus
CCC approval		CCC approval / marking not required for products rated ≤36 V
Ambient conditions		
Ambient temperature		-40 ... 60 °C (-40 ... 140 °F)
Storage temperature		-40 ... 75 °C (-40 ... 167 °F)
Mechanical specifications		

Release date: 2023-03-28 Date of issue: 2023-03-28 Filename: 288060_eng.pdf

Technical Data

Housing width	41.5 mm
Housing height	49 mm
Housing depth	15 mm
Degree of protection	IP67
Connection	Metal connector, M12, 5-pin, 90° rotatable
Material	
Housing	Frame: nickel plated, die cast zinc, Laterals: glass-fiber reinforced plastic PC
Optical face	Plastic pane
Mass	60 g

Connection Assignment

Option:

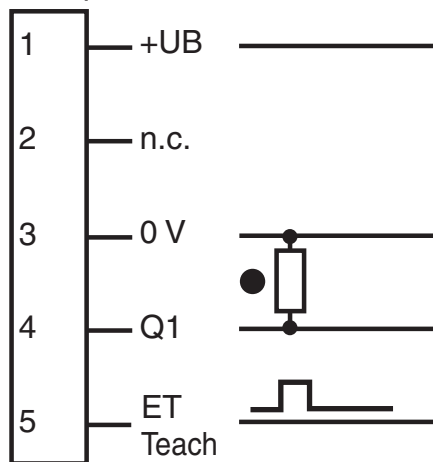

○ = Light on
● = Dark on

Connection Assignment

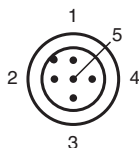

Wire colors in accordance with EN 60947-5-2

1	BN	(brown)
2	WH	(white)
3	BU	(blue)
4	BK	(black)
5	GY	(gray)

Assembly

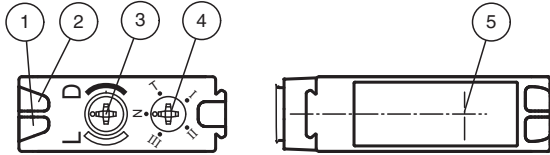

1	Operating display	green
2	Switch state	yellow
3	Bright/dark switch	
4	Teach-In switch	
5	Optical axis	

Characteristic Curve

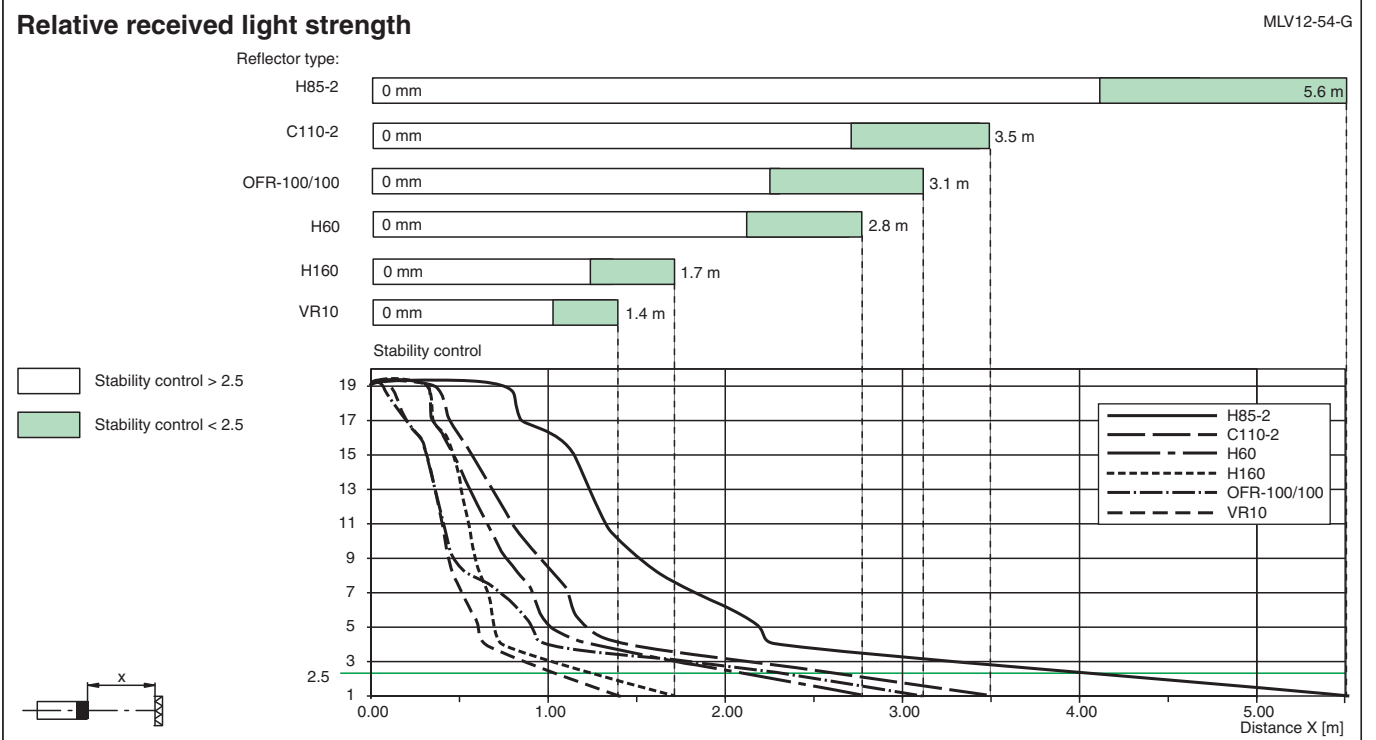
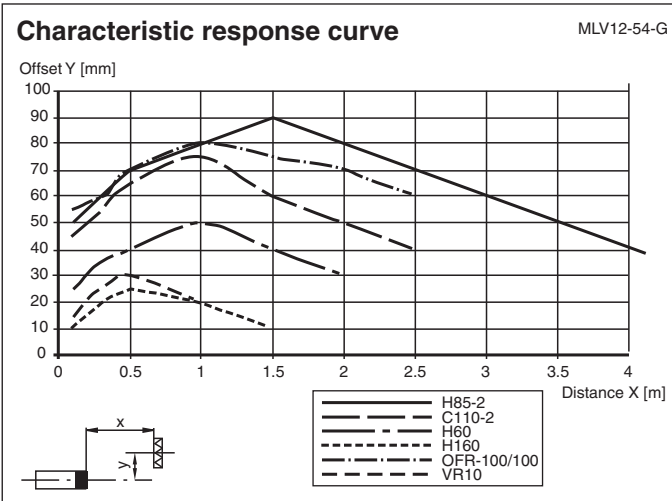





Accessories

	OMH-MLV12-HWG	Mounting bracket for series MLV12 sensors
--	----------------------	---

Release date: 2023-03-28 Date of issue: 2023-03-28 Filename: 288060_eng.pdf

Accessories

	OMH-MLV12-HWK	Mounting bracket for series MLV12 sensors
	OMH-K01	dove tail mounting clamp
	OMH-K02	dove tail mounting clamp
	OMH-K03	dove tail mounting clamp
	OMH-06	Mounting aid for round steel ø 12 mm or sheet 1.5 mm ... 3 mm

Teach-In

Teach-IN

Schalterstellung "N" (Normalbetrieb):

LEDs gelb leuchten bei freiem Lichtstrahl, blinken bei Unterschreiten der Funktionsreserve, aus bei Strahlunterbrechung

Schalterstellung "T" (TEACH-IN Betrieb):

LED gelb blinkt nach 1s langsam (ca. 1,5 Hz).

Der Sensor ist nun bereit, über den mechanischen Schalter (Stellung I, II, III) oder ein externes Signal für einen bestimmten Kontrasterkennungswert eingestellt zu werden.

Schalterstellungen "I", "II" und "III" (Kontrasterkennungs-Betrieb)

Kontrasterkennungswerte: I für 10 %, II für 18 %, III für 30 %

1. LED gelb leuchtet konstant: Lichtweg frei

2. LED gelb aus: Objekt erkannt

3. LED gelb schnell blinkend: keine sichere Erfassung, Verschmutzung zu groß, Funktionsreserve zu gering.

Es ist eine direkte Umschaltung der Kontrasterkennungsstufen möglich, ohne vorher noch mal den Schalter in Stellung "T" bringen zu müssen.

Externer Teach-Eingang (ET):

In Schalterstellung "T" kann durch externes Anlegen eines Impulses über eine Steuerleitung an Stecker-Pin 5 die entsprechende Kontrasterkennung gewählt werden.

Die gewünschte Kontrasterkennung wird durch Anlegen eines High-Impulses bestimmter Breite eingestellt:

I: 50 ms (30 ms ... 100 ms)

II: 150 ms (100 ms ... 200 ms)

III: > 200 ms

Vorausfallausgang (optional):

Schalterstellung "N":

Inaktiv bei Unterschreiten der Funktionsreserve nach ca. 5s. Sofort inaktiv, wenn innerhalb der Blinkzeit 4 Lichtstrahlunterbrechungen stattfinden.

Kontrasterkennungsstufen:

Der Ausgang wird inaktiv, wenn die Verschmutzung keine Nachregelung mehr zulässt, gelbe LED blinkt schnell. Bei weiterer Verschmutzung ist eine Erkennung geringer Kontraste nicht mehr sichergestellt.

Warmlaufzeit:

Eine eventuelle Warmlaufzeit kann durch ein erneutes Einlernen (teachen) verkürzt werden.

Switch position "N" (normal operation):

Yellow LEDs light if the light beam is free, flash if the functional reserve is used, turn off if the light beam is interrupted.

Switch position "T" (TEACH-IN operation):

Yellow LED flashes slowly after 1 second (about 1.5 Hz).

The sensor is now ready to be set to a particular contrast detection value using the mechanical switch (position I, II, or III) or an external signal.

Switch positions "I", "II", and "III" (contrast detection operation)

Contrast detection values: I for 10 %, II for 18 %, III for 30 %.

1. Yellow LED lights continually: light path free

2. Yellow LED off: object detected

3. Yellow LED flashes quickly: unsure detection, too much contamination, functional reserve too low.

A direct switching of the contrast detection levels is possible without having to put the switch back into position "T" first.

External teach input (ET):

In switch position "T", you can apply a pulse over a control line to plug pin 5 to select the corresponding contrast detection.

The desired contrast detection is set by applying a high pulse of a particular width:

I: 50 ms (30 ms ... 100 ms)

II: 150 ms (100 ms ... 200 ms)

III: >200 ms

Pre-fault output (optional):

Switch position "N":

Inactive if the functional reserve is used after approx. 5 sec. Immediately inactive if 4 light beam interruptions occur within the flashing time.

Contrast detection levels:

The output goes inactive if the contamination no longer permits readjustment; the yellow LED flashes quickly. In the case of additional contamination, the detection of low contrast is no longer guaranteed.

Warm-up period:

Any warm-up period can be shortened by repeating the learn (teach) process.

