

Cable Glands, Plastic

CG.PIDS1.M12.PA.C.15.K50



- For cables without armor
- Thread M12
- Thread length 15 mm
- Ex eb and Ex tb certified
- Blue marking for use with Ex i circuits
- High impact-resistant polyamide material
- Seal chloroprene
- Suitable for operation in Zone 1, Zone 2, Zone 21 and Zone 22
- Very large clamping range due to double sealing insert
- Full impact resistance of 7 J according to IEC/EN 60079-0 for the full range without limitations
- Packaging unit: 50 pieces, without accessories



Dimensions

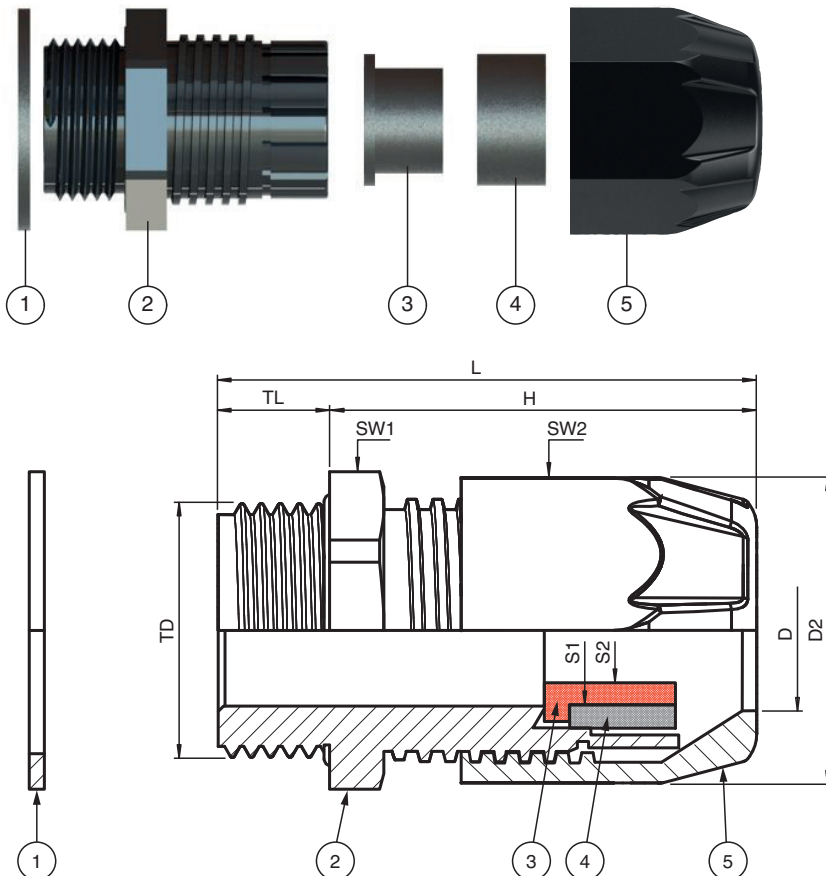

Release date: 2025-04-08 Date of issue: 2025-04-08 Filename: 291356_eng.pdf

Dimensions

Details see data table

Legend	
1	Flat gasket
2	Gland body basis
3	Seal insert S3
4	Seal insert S2
5	Cap nut
D	Clamping range, cable sheath diameter
D2	Width across corners
H	Length outside enclosure
L	Total length
S*	Clamping range, seal insert combinations
SW*	Width across flats
TD	Thread size
TL	Thread length

Technical Data

Mechanical specifications

Cable type	non-armored cables
Clamping range (D)	3 ... 6.5 mm
Seal combination S1	4 ... 6.5 mm
Seal combination S1+S2	3 ... 4 mm
Thread type	metric ISO pitch 1.5 mm
Thread size (TD)	M12
Degree of protection	IP66 / IP68
Material	
Endcaps	blue
Finish	inherent color black, cap nut blue
Cable gland	high impact-resistant polyamide
Washer gasket	flat chloroprene gasket
Seal insert	chloroprene
Mass	
Individual component	approx. 7 g
Packing unit	approx. 214 g
Dimensions	
Width across corners (D2)	17 mm
Diameter thru-hole (DT)	12 ... 12.2 mm
Length outside enclosure (H)	25.3 mm
Width across flats (SW1)	15 mm
Width across flats (SW2)	15 mm
Thread length (TL)	15 mm
Total length (L)	45.3 mm
Tightening torque	
Nut torque at enclosure (SW1)	1.5 Nm
Nut torque 2 with seal S1 (SW2)	2 Nm
Nut torque 2 with seals S1+S2 (SW2)	1 Nm
Ambient conditions	
Ambient temperature	-40 ... 70 °C (-40 ... 158 °F)
Data for application in connection with hazardous areas	

Release date: 2025-04-08 Date of issue: 2025-04-08 Filename: 291356_eng.pdf

Technical Data

EU-type examination certificate	IMQ 15 ATEX 006X
Marking	Ⓜ II 2 GD Ex eb IIC Gb Ex tb IIC Db
International approvals	
IECEX approval	IECEX IMQ 15.0001X
UKCA approval	CML 22 UKEX 31379X
INMETRO approval	DNV 20.0030 X
CCC approval	2021312313000450
Conformity	
Degree of protection	EN 60529
General information	
Delivery quantity	50
Scope of delivery	Cable glands Brief instructions (1 copy)
Supplementary information	EC-Type Examination Certificate, Statement of Conformity, Declaration of Conformity, Attestation of Conformity and instructions have to be observed where applicable. For information see www.pepperl-fuchs.com .
Accessories	
Sealing plugs	BP.PDS.M12.PA