

Stopping Plugs, Metal, Hexagon Head

SP.MD.M25.BN.C.15.K01

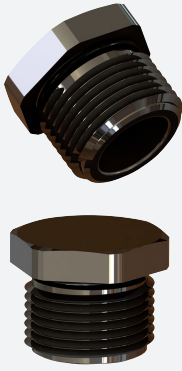

- Stopping plug for unused cable entries
- Brass nickel-plated
- Thread M25
- Hexagon head
- Ex db, Ex eb and Ex tb certified
- Seal chloroprene
- Suitable for operation in Zone 1, Zone 2, Zone 21 and Zone 22
- Suitable for operation in Class I, Zone 1/2/22
- Suitable for operation in Class I, Division 2 when installed in accordance with NEC501.10(B)(2)
- Degree of protection IP66 / IP68, UL Type 4X
- Packaging unit: 1 piece, kit with accessories



Dimensions

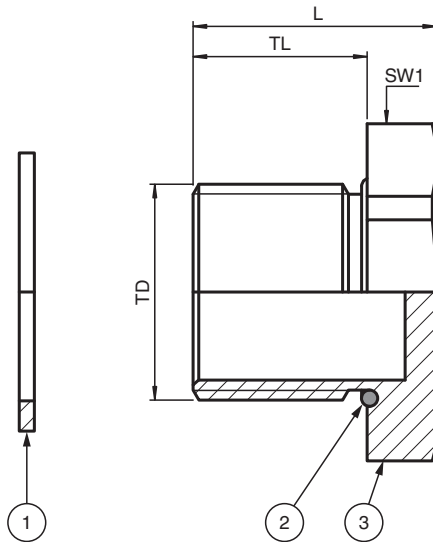

Dimensions

Details see data table

Legend	
1	Washer gasket (accessory, metric versions only)
2	O-Ring (metric versions only)
3	Stopping plug
L	Total length
SW*	Width across flats
TD	Thread size
TL	Thread length

Technical Data

Mechanical specifications

Thread type	metric ISO pitch 1.5 mm
Thread size (TD)	M25
Degree of protection	IP66 / IP68 , UL Type 4X
Material	
Finish	inherent color silver
Washer gasket	aramid fibers bonded with NBR
O-Ring	chloroprene
Stopping plug	brass, nickel-plated
Mass	
Individual component	approx. 49 g
Packing unit	approx. 68 g
Dimensions	
Diameter thru-hole (DT)	25 ... 25.2 mm
Width across flats (SW1)	30 mm
Thread length (TL)	15.5 mm
Total length (L)	21 mm
Tightening torque	
Nut torque at enclosure (SW1)	8.5 Nm

Ambient conditions

Ambient temperature	-40 ... 100 °C (-40 ... 212 °F) washer gasket: -40 ... 80 °C (-40 ... 176 °F)
---------------------	--

Data for application in connection with hazardous areas

EU-type examination certificate	CESI 15 ATEX 029X
Marking	⊕ II 2 GD Ex db IIC Gb Ex eb IIC Gb Ex tb IIIC Db

International approvals

UL approval	
cULus	E305142 tested to UL 50E and UL 508A CSA C22.2, No. 14-13
IECEx approval	IECEx CES 15.0006X
UKCA approval	CML 22 UKEX 1267X
CCC approval	2021312313000343

Conformity

Degree of protection	EN 60529
----------------------	----------

General information

Delivery quantity	1
-------------------	---

Technical Data

Scope of delivery	Stopping Plugs, Metal washer gasket locknut Brief instructions
Supplementary information	EC-Type Examination Certificate, Statement of Conformity, Declaration of Conformity, Attestation of Conformity and instructions have to be observed where applicable. For information see www.pepperl-fuchs.com .