

Stopping Plugs, Metal, Hexagon Head SP.MD.M20.SS.C.15.K01

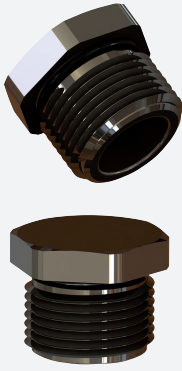

- Stopping plug for unused cable entries
- Stainless Steel
- Thread M20
- Hexagon head
- Ex db, Ex eb and Ex tb certified
- Seal chloroprene
- Suitable for operation in Zone 1, Zone 2, Zone 21 and Zone 22
- Suitable for operation in Class I, Zone 1/2/22
- Suitable for operation in Class I, Division 2 when installed in accordance with NEC501.10(B)(2)
- Degree of protection IP66 / IP68, UL Type 4X
- Packaging unit: 1 piece, kit with accessories



Dimensions

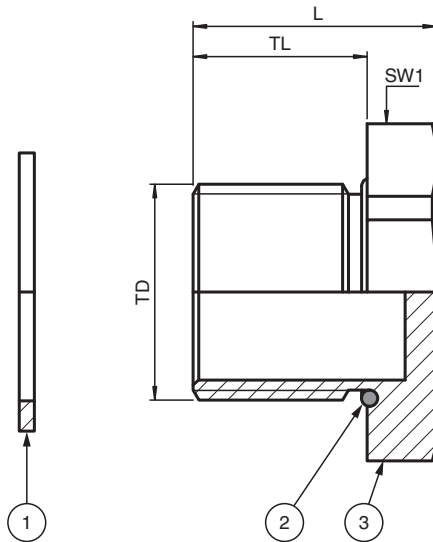

Dimensions

Details see data table

Legend	
1	Washer gasket (accessory, metric versions only)
2	O-Ring (metric versions only)
3	Stopping plug
L	Total length
SW*	Width across flats
TD	Thread size
TL	Thread length

Technical Data

Mechanical specifications

Thread type	metric ISO pitch 1.5 mm
Thread size (TD)	M20
Degree of protection	IP66 / IP68 , UL Type 4X
Material	
Finish	inherent color silver
Washer gasket	aramid fibers bonded with NBR
O-Ring	chloroprene
Stopping plug	stainless steel
Mass	
Individual component	approx. 34 g
Packing unit	approx. 46 g
Dimensions	
Diameter thru-hole (DT)	20 ... 20.2 mm
Width across flats (SW1)	25 mm
Thread length (TL)	15.5 mm
Total length (L)	21 mm
Tightening torque	
Nut torque at enclosure (SW1)	6 Nm

Ambient conditions

Ambient temperature	-40 ... 100 °C (-40 ... 212 °F) washer gasket: -40 ... 80 °C (-40 ... 176 °F)
---------------------	--

Data for application in connection with hazardous areas

EU-type examination certificate	CESI 15 ATEX 029X
Marking	⊕ II 2 GD Ex db IIC Gb Ex eb IIC Gb Ex tb IIIC Db

International approvals

UL approval	
cULus	E305142 tested to UL 50E and UL 508A CSA C22.2, No. 14-13
IECEx approval	IECEx CES 15.0006X
UKCA approval	CML 22 UKEX 1267X
CCC approval	2021312313000343

Conformity

Degree of protection	EN 60529
----------------------	----------

General information

Delivery quantity	1
-------------------	---

Technical Data

Scope of delivery	Stopping Plugs, Metal washer gasket locknut Brief instructions
Supplementary information	EC-Type Examination Certificate, Statement of Conformity, Declaration of Conformity, Attestation of Conformity and instructions have to be observed where applicable. For information see www.pepperl-fuchs.com .