

Connection cable

V11-W-BK2M-PUR-R1-V3-GM



- Highly flexible - suitable for robotics
- Suitable for drag chains and abrasion resistant
- Suitable for robotic applications / torsion resistant
- Degree of protection IP68 / IP69
- Free of paint wetting interfering substances
- Resistant to microbes and hydrolysis
- Oil resistant
- Resistant to salt water
- UL listed for USA and Canada
- Halogen-free
- Specific design protects against loosening and inaccurate installation

Cordset M12 socket angled A-coded 3-pin to M8 plug straight A-coded 3-pin, PUR cable black, UL approved, drag chain suitable, torsion resistant, oil and salt water resistant, robotics



Dimensions

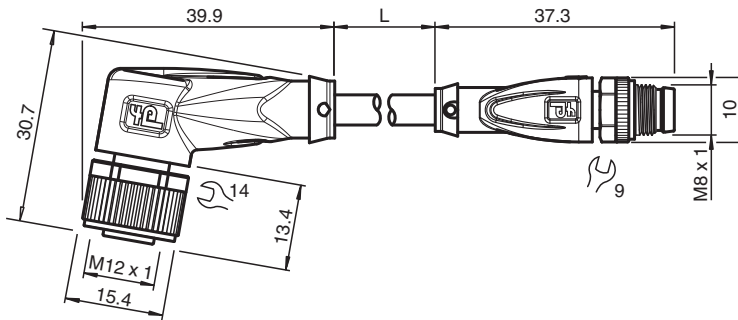

Technical Data

General specifications

| | | |
|--------------------|--|------------------|
| Connector 1 | | |
| Connection | | socket |
| Construction type | | M12 |
| Style | | angled |
| Locking | | screw connection |
| Number of pins | | 3 |
| Coding | | A-coded |
| Connector 2 | | |
| Connection | | plug |
| Construction type | | M8 |
| Style | | straight |
| Locking | | screw connection |
| Number of pins | | 3 |
| Coding | | A-coded |

Electrical specifications

| | | |
|-------------------|-------|------------------------|
| Operating voltage | U_B | max. 48 V AC / 60 V DC |
| Operating current | I_B | max. 3 A |

Conformity

Release date: 2023-07-10 Date of issue: 2023-07-10 Filename: 295370_eng.pdf

Technical Data

| | | |
|-----------------------------------|---|---|
| Degree of protection | | EN 60529 |
| Plug connection | | connector M12 x 1 : IEC 61076-2-101 connector M8 x 1 : IEC 61076-2-104 |
| Flammability | | UL 758 / 1581 |
| Halogen-free | | DIN VDE 0472-815 DIN EN 50267-2-1 |
| Microbial resistance | | DIN EN 50525-2-21 / DIN VDE 0282-10 |
| Hydrolysis resistance | | DIN EN 50525-2-21 |
| Oil resistance | | DIN EN 60811-2-1 |
| Approvals and certificates | | |
| UL approval | | AWM STYLE 20549 80 °C 300V AWM I A/B 80 °C 300V FT2 (cable) |
| UL File Number | | E231213 |
| Ambient conditions | | |
| Ambient temperature | | |
| Plug connector | | -40 ... 90 °C (-40 ... 194 °F) |
| Cable, fixed | | -40 ... 80 °C (-40 ... 176 °F) |
| Cable, flexing | | -25 ... 80 °C (-13 ... 176 °F) |
| Pollution degree | | 3 |
| Mechanical specifications | | |
| Connector 1 | | |
| Tightening torque | | 0.6 Nm |
| Loosening protection | | available |
| Tool installation | | straight knurling and hexagon nut SW = 14 mm |
| Mating cycles | | min. 100 |
| Degree of protection | | IP68 / IP69 |
| Connector 2 | | |
| Tightening torque | | 0.4 Nm |
| Loosening protection | | available |
| Tool installation | | straight knurling and hexagon nut SW = 9 mm |
| Mating cycles | | min. 100 |
| Degree of protection | | IP68 |
| Cable | | |
| Sheath diameter | | 4.3 mm |
| Bending radius | | > 10 x cable diameter, moving > 5 x cable diameter, fixed |
| Sheath stripping force | | max. 50 N / 300 mm |
| Sheath color | | black (similar to RAL 7021) |
| Number of cores | | 4 |
| Core cross section | | 0.34 mm ² |
| Cores color | | Core 1: brown Core 2: not used Core 3: blue Core 4: black |
| Core construction | | 42 x 0.1 mm Ø |
| Length | L | 2 m |
| Cable code | | Li 9Y 11YM 4 x 0.34 |
| Drag chain suitability | | |
| Drag chain cycles | | min. 10000000 |
| Motion velocity | | max. 3 m/s |
| Traverse distance | | max. 10 m |
| Acceleration | | max. 10 m/s ² |
| Torsion cycles | | min. 10000000 |
| Torsional stress | | ± 360 °/m |
| Material | | |
| PWIS free | | yes |







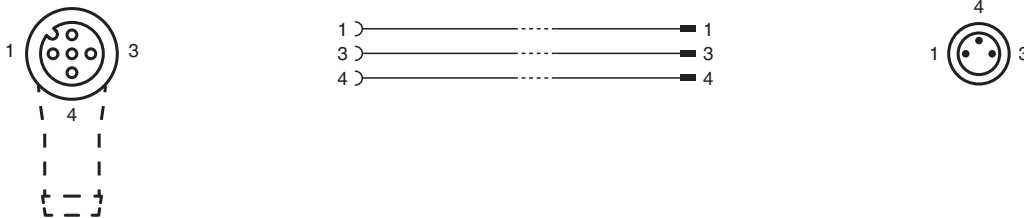

Technical Data

| | |
|-----------------------|-----------------------------|
| Halogen-free | yes |
| Plug connector | |
| Screw connection | Zinc diecast, nickel-plated |
| Body | TPU, black |
| Seal | FKM |
| Contact surface | gold plated (Au) |
| Flammability | V-2 |
| Cable | |
| Sheathing | PUR based on polyether |
| Core insulation | PP |
| Salt water resistance | yes |
| Oil resistance | yes |
| Microbial resistance | yes |
| Hydrolysis resistance | yes |
| Flammability | FT2 |

Connection



Accessories

| | | |
|---|------------------------------|--|
|  | MH V1-SCREWDRIVER | Torque screwdriver (0.6 Nm) |
|  | MH V1-BIT M12 | plug-in cap M12 |
|  | V1/V3-LABELHOLDER | Label holder |
|  | V1/V3-LABEL | Label plate |
|  | MH V1-Holder | Modular universal holder for M12 connectors |
|  | V1-CLIP | Unlocking protector for M12 connector |
|  | V1-MARKING-RING-COLOR | Marking rings for M12 connectors, various colors |
|  | MH V3-SCREWDRIVER | Torque screwdriver (0.4 Nm) |
|  | MH V3-BIT M8 | plug-in cap for M8 |

Release date: 2023-07-10 Date of issue: 2023-07-10 Filename: 295370_eng.pdf

Accessories



MH V3-Holder

Modular universal holder for M8 connectors