



Laser retroreflective sensor OBR25M-R201-EP-IO-0,3M-V3-L



- Medium design with versatile mounting options
- DuraBeam Laser Sensors - durable and employable like an LED
- Extended temperature range
-40 °C ... 60 °C
- High degree of protection IP69K
- IO-Link interface for service and process data

Laser retroreflective sensor



IO-Link

Function

The optical sensors in the series are the first devices to offer an end-to-end solution in a medium-sized standard design – from the thru-beam sensor through to the measuring distance sensor. As a result of this design, the sensors are able to perform practically all standard automation tasks.

The entire series enables sensors to communicate via IO-Link.

The DuraBeam laser sensors are durable and can be used in the same way as a standard sensor.

Multi Pixel Technology (MPT) ensures that the standard sensors are flexible and can be adapted to the application environment.

Dimensions

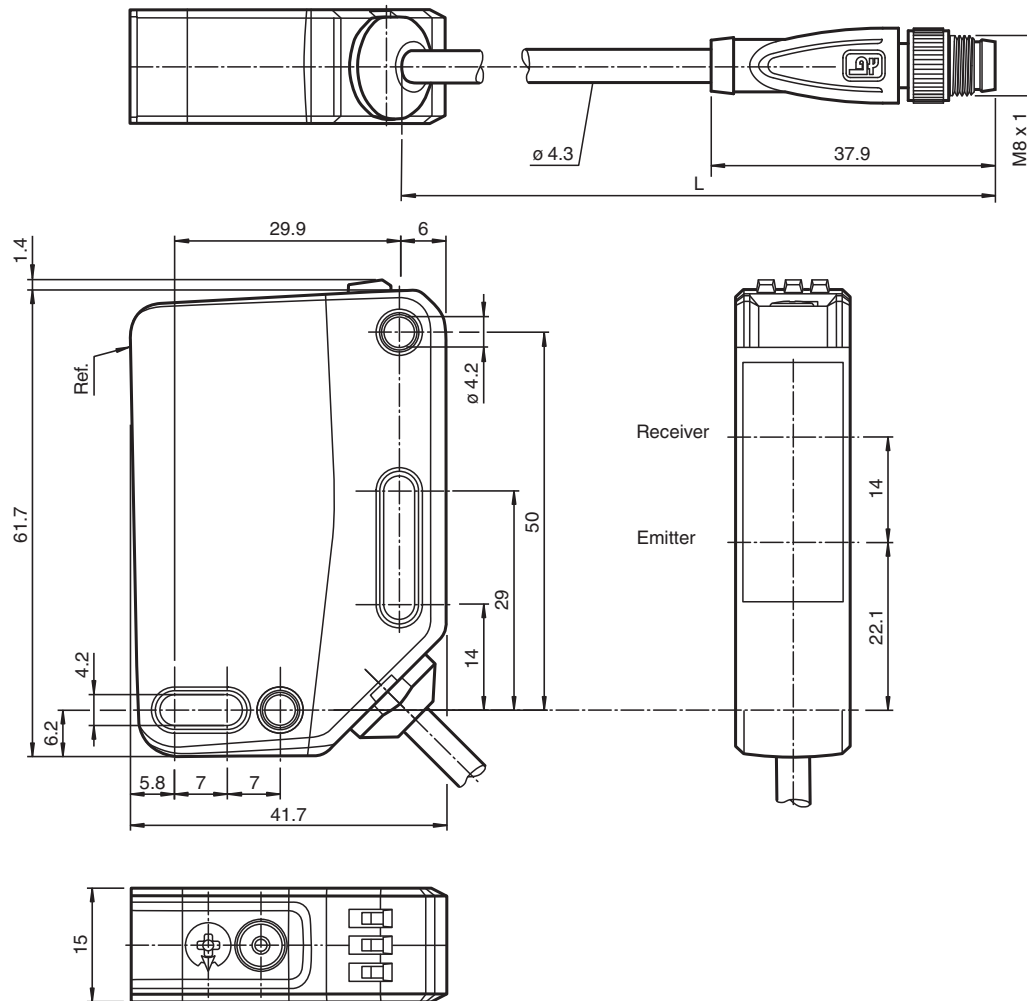

Technical Data

General specifications

| | |
|---|--|
| Effective detection range | 0 ... 25 m |
| Reflector distance | 0.5 ... 25 m |
| Threshold detection range | 33 m |
| Reference target | H85-2 reflector |
| Light source | laser diode |
| Light type | modulated visible red light |
| Polarization filter | yes |
| Laser nominal ratings | |
| Note | LASER LIGHT , DO NOT STARE INTO BEAM |
| Laser class | 1 |
| Wave length | 680 nm |
| Beam divergence | > 5 mrad $d_{63} < 2$ mm in the range of 250 mm ... 750 mm |
| Pulse length | 1.6 μ s |
| Repetition rate | max. 17.6 kHz |
| max. pulse energy | 9.6 nJ |
| Diameter of the light spot | approx. 50 mm at a distance of 25 m |
| Opening angle | approx. 0.1 ° |
| Ambient light limit | EN 60947-5-2 : 60000 Lux |
| Functional safety related parameters | |
| MTTF _d | 672 a |

Technical Data

| | | |
|-----------------------------------|----------------|---|
| Mission Time (T _M) | | 20 a |
| Diagnostic Coverage (DC) | | 0 % |
| Indicators/operating means | | |
| Operation indicator | | LED green: constantly on - power on flashing (4Hz) - short circuit flashing with short break (1 Hz) - IO-Link mode |
| Function indicator | | Yellow LED: Permanently lit - light path clear Permanently off - object detected Flashing (4 Hz) - insufficient operating reserve |
| Control elements | | Light-on/dark-on changeover switch |
| Control elements | | sensitivity adjustment |
| Electrical specifications | | |
| Operating voltage | U _B | 10 ... 30 V DC |
| Ripple | | max. 10 % |
| No-load supply current | I ₀ | < 15 mA at 24 V Operating voltage |
| Protection class | | III |
| Interface | | |
| Interface type | | IO-Link (via C/Q = pin 4) |
| IO-Link revision | | 1.1 |
| Device profile | | Identification and diagnosis Smart Sensor type 2.4 |
| Device ID | | 0x111212 (1118738) |
| Transfer rate | | COM2 (38.4 kBit/s) |
| Min. cycle time | | 2.3 ms |
| Process data width | | Process data input 2 Bit Process data output 2 Bit |
| SIO mode support | | yes |
| Compatible master port type | | A |
| Output | | |
| Switching type | | The switching type of the sensor is adjustable. The default setting is: C/Q - Pin4: NPN normally open / dark-on, PNP normally closed / light-on, IO-Link |
| Signal output | | 1 push-pull (4 in 1) output, short-circuit protected, reverse polarity protected, overvoltage protected |
| Switching voltage | | max. 30 V DC |
| Switching current | | max. 100 mA , resistive load |
| Usage category | | DC-12 and DC-13 |
| Voltage drop | U _d | ≤ 1.5 V DC |
| Switching frequency | f | 2000 Hz |
| Response time | | 250 μs |
| Conformity | | |
| Communication interface | | IEC 61131-9 |
| Product standard | | EN 60947-5-2 |
| Laser safety | | EN 60825-1:2014 |
| Approvals and certificates | | |
| UL approval | | E87056 , cULus Listed , class 2 power supply , type rating 1 |
| CCC approval | | CCC approval / marking not required for products rated ≤36 V |
| FDA approval | | IEC 60825-1:2014 Complies with 21 CFR 1040.10 and 1040.11 except for conformance with IEC 60825-1 Ed. 3 as described in Laser Notice 56, dated May 8, 2019. |
| Ambient conditions | | |
| Ambient temperature | | -40 ... 60 °C (-40 ... 140 °F) , cable, fixed installation -20 ... 60 °C (-4 ... 140 °F) , movable cable not appropriate for conveyor chains |
| Storage temperature | | -40 ... 70 °C (-40 ... 158 °F) |
| Mechanical specifications | | |
| Degree of protection | | IP67 / IP69 / IP69K |
| Connection | | 300 mm fixed cable with M8 x 1, 3-pin connector |

Release date: 2025-01-17 Date of issue: 2025-01-17 Filename: 295670-100084_eng.pdf

Technical Data

| | |
|--------------|--------------------|
| Material | |
| Housing | PC (Polycarbonate) |
| Optical face | PMMA |
| Mass | approx. 51 g |
| Dimensions | |
| Height | 61.7 mm |
| Width | 15 mm |
| Depth | 41.7 mm |
| Cable length | 0.3 m |

Connection

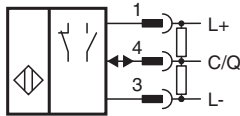

Connection Assignment



Wire colors in accordance with EN 60947-5-2

| | | |
|---|----|---------|
| 1 | BN | (brown) |
| 3 | BU | (blue) |
| 4 | BK | (black) |

Assembly

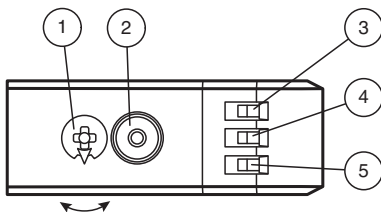

| | | |
|---|--------------------------------------|----|
| 1 | Sensitivity adjustment | |
| 2 | Light-on / dark-on changeover switch | |
| 3 | Operating indicator / dark on | GN |
| 4 | Signal indicator | YE |
| 5 | Operating indicator / light on | GN |

Release date: 2025-01-17 Date of issue: 2025-01-17 Filename: 295670-100084_eng.pdf

Characteristic Curve

Characteristic response curve

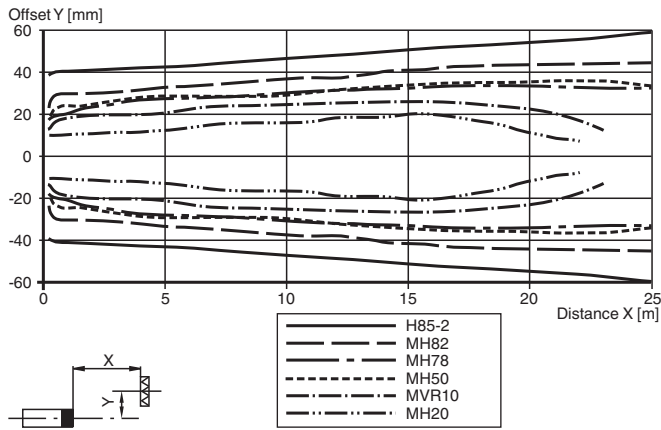

Relative received light strength (typical)

Reflector type:

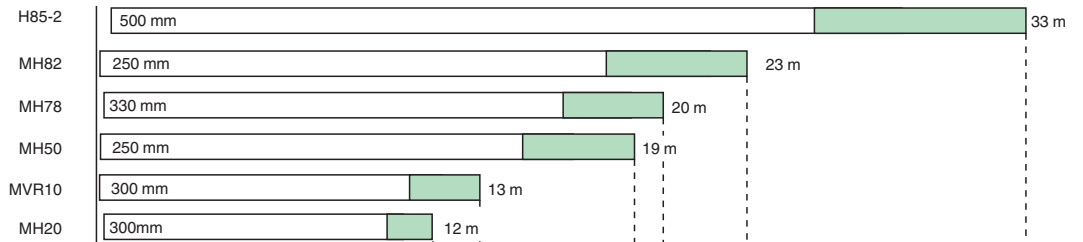

Excess gain > 2
Excess gain < 2

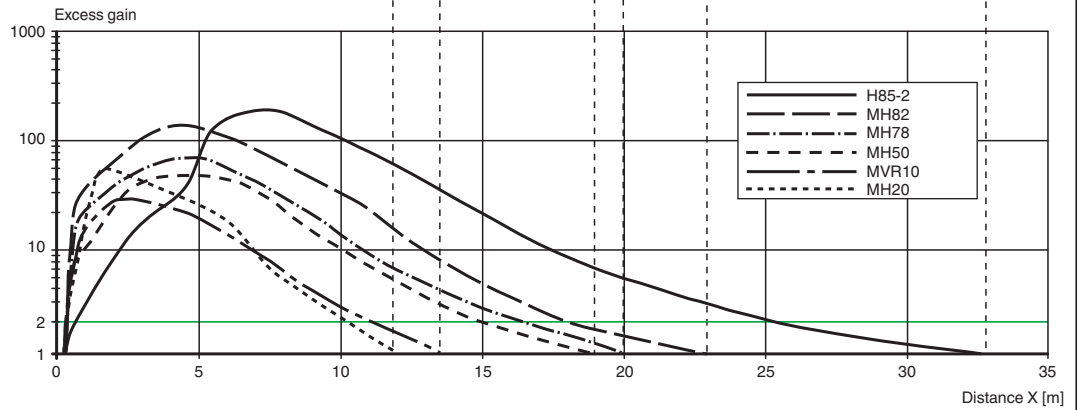

Release date: 2025-01-17 Date of issue: 2025-01-17 Filename: 295670-100084_eng.pdf

Safety Information

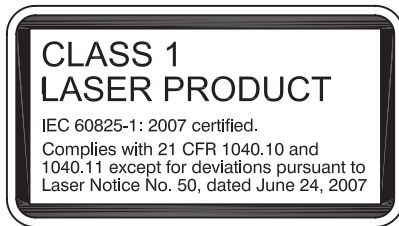
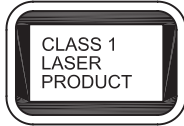

Commissioning

To unlock the adjustment functions turn the sensing range / sensitivity adjuster for more than 180 degrees.

Sensing Range / Sensitivity

Turn sensing range / sensitivity adjuster clockwise to increase sensing range / sensitivity.
Turn sensing range / sensitivity adjuster counter clockwise to decrease sensing range / sensitivity.
If the end of the adjustment range is reached, the signal indicator starts flashing with 8 Hz.

Light-on / Dark-on Configuration

Press the light-on / dark-on changeover switch for more than 1 second (less than 4 seconds). The light-on / dark-on mode changes and the operating indicators are activated accordingly.
If you press the light-on / dark-on changeover switch for more than 4 seconds, the light-on / dark-on mode changes back to the original setting. On release of the light-on / dark-on changeover switch the current state is activated.

Restore Factory Settings

Press the light-on / dark-on changeover switch for more than 10 seconds (less than 30 seconds) until all LEDs turn off. On release of the light-on / dark-on changeover switch the signal indicator turns on. After 5 seconds the sensor resumes operation with factory default settings.
After 5 minutes of inactivity the sensing range / sensitivity adjustment is locked. In order to reactivate the sensing range / sensitivity adjustment, turn the sensing range / sensitivity adjuster for more than 180 degrees.