



Triangulation sensor (BGS) OBT650-R200-2EP-IO-0,3M-V31



- Medium design with versatile mounting options
- Best background suppressor in its class
- Precision object detection, almost irrespective of the color
- Extended temperature range
-40 °C ... 60 °C
- High degree of protection IP69K
- IO-Link interface for service and process data

Triangulation sensor with background suppression



Function

The optical sensors in the series are the first devices to offer an end-to-end solution in a medium-sized standard design – from the thru-beam sensor through to the measuring distance sensor. As a result of this design, the sensors are able to perform practically all standard automation tasks.

The entire series enables sensors to communicate via IO-Link.

The DuraBeam laser sensors are durable and can be used in the same way as a standard sensor.

Multi Pixel Technology (MPT) ensures that the standard sensors are flexible and can be adapted to the application environment.

Dimensions

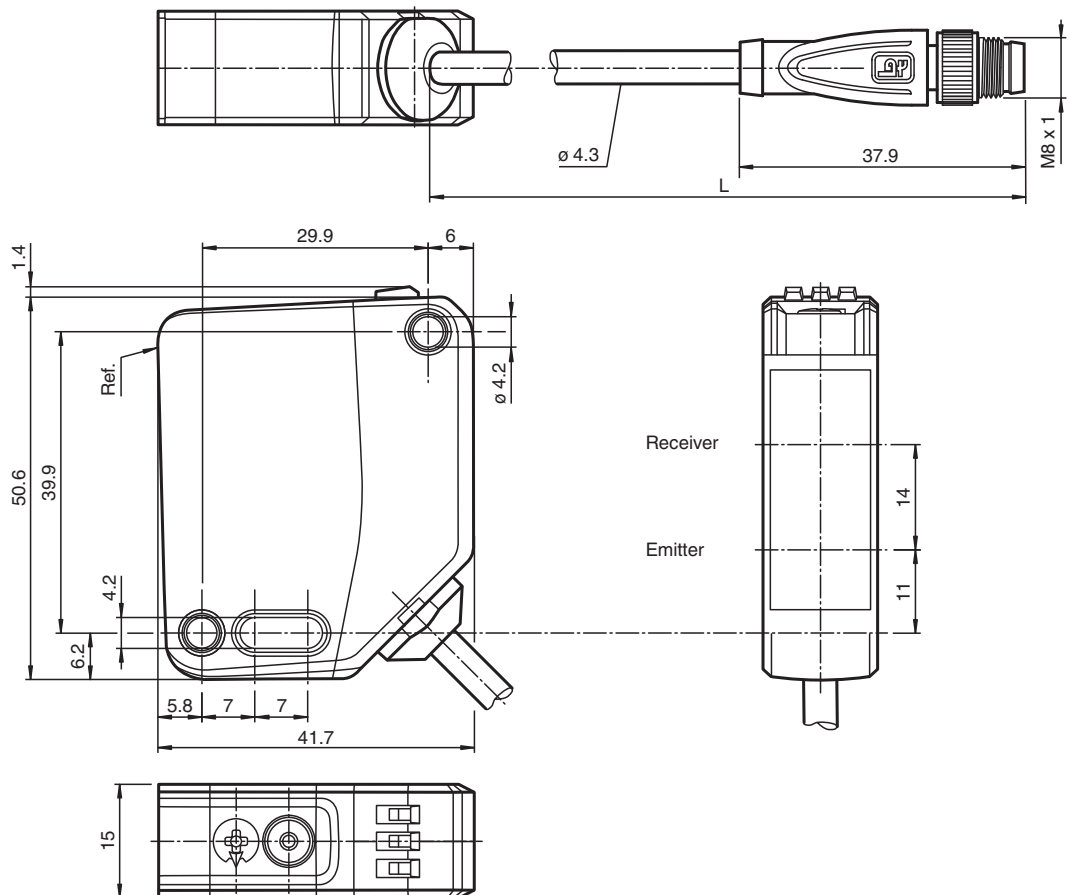

Technical Data

General specifications		
Detection range		10 ... 650 mm
Detection range min.		10 ... 100 mm
Detection range max.		10 ... 650 mm
Adjustment range		100 ... 650 mm
Reference target		standard white, 100 mm x 100 mm
Light source		LED
Light type		modulated visible red light
LED risk group labelling		exempt group
Black-white difference (6%/90%)		< 6 % at 650 mm
Diameter of the light spot		approx. 20 mm x 20 mm at a distance of 650 mm
Opening angle		approx. 2 °
Ambient light limit		EN 60947-5-2 : 70000 Lux
Functional safety related parameters		
MTTF _d		600 a
Mission Time (T _M)		20 a
Diagnostic Coverage (DC)		0 %
Indicators/operating means		
Operation indicator		LED green: constantly on - power on flashing (4Hz) - short circuit flashing with short break (1 Hz) - IO-Link mode
Function indicator		LED yellow: constantly on - object detected constantly off - object not detected
Control elements		Light-on/dark-on changeover switch
Control elements		Sensing range adjuster
Electrical specifications		
Operating voltage	U _B	10 ... 30 V DC
Ripple		max. 10 %
No-load supply current	I ₀	< 25 mA at 24 V supply voltage
Protection class		III
Interface		
Interface type		IO-Link (via C/Q = pin 4)
IO-Link revision		1.1
Device profile		Identification and diagnosis Smart Sensor type 2.4
Device ID		0x111601 (1119745)
Transfer rate		COM2 (38.4 kBit/s)
Min. cycle time		2.3 ms
Process data width		Process data input 1 Bit Process data output 2 Bit
SIO mode support		yes
Compatible master port type		A
Output		
Switching type		The switching type of the sensor is adjustable. The default setting is: C/Q - Pin4: NPN normally open / light-on, PNP normally closed / dark-on, IO-Link /Q - Pin2: NPN normally closed / dark-on, PNP normally open / light-on
Signal output		2 push-pull (4 in 1) outputs, short-circuit protected, reverse polarity protected, overvoltage protected
Switching voltage		max. 30 V DC
Switching current		max. 100 mA , resistive load
Usage category		DC-12 and DC-13
Voltage drop	U _d	≤ 1.5 V DC
Switching frequency	f	500 Hz
Response time		1 ms
Conformity		

Release date: 2023-01-24 Date of issue: 2023-01-24 Filename: 295670-100110_eng.pdf

Technical Data

Communication interface	IEC 61131-9
Product standard	EN 60947-5-2
Approvals and certificates	
UL approval	E87056 , cULus Listed , class 2 power supply , type rating 1
CCC approval	CCC approval / marking not required for products rated ≤36 V
Ambient conditions	
Ambient temperature	-40 ... 60 °C (-40 ... 140 °F) , fixed cable -20 ... 60 °C (-4 ... 140 °F) , movable cable not appropriate for conveyor chains
Storage temperature	-40 ... 70 °C (-40 ... 158 °F)
Mechanical specifications	
Housing width	15 mm
Housing height	50.6 mm
Housing depth	41.7 mm
Degree of protection	IP67 / IP69 / IP69K
Connection	fixed cable 300 mm with M8 x 1 male connector; 4-pin
Material	
Housing	PC (Polycarbonate)
Optical face	PMMA
Mass	approx. 43 g
Cable length	0.3 m

Connection

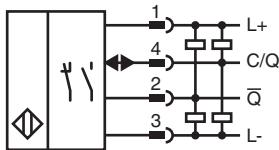

Connection Assignment



Wire colors in accordance with EN 60947-5-2

1	BN	(brown)
2	WH	(white)
3	BU	(blue)
4	BK	(black)

Assembly

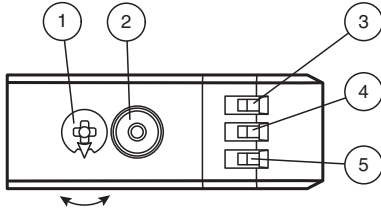





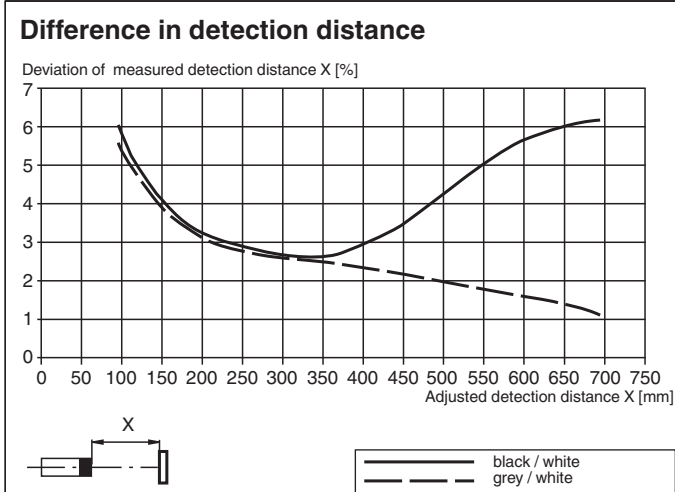
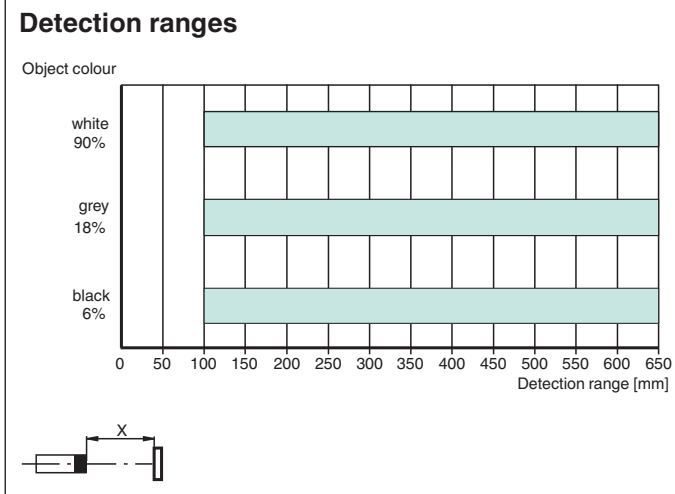
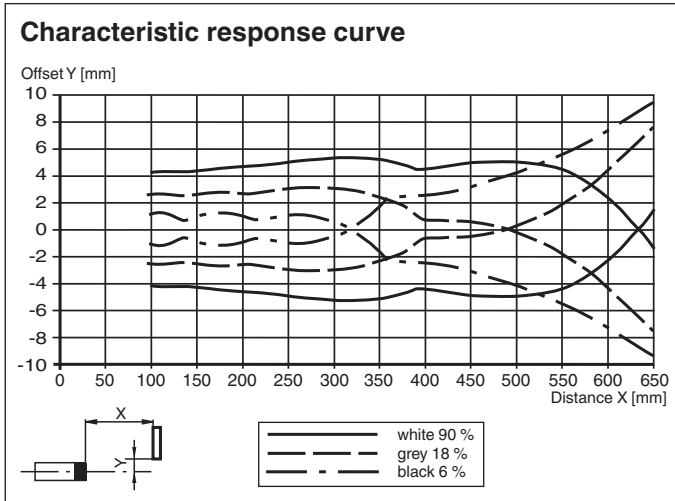









1	Sensitivity adjustment	
2	Light-on / dark-on changeover switch	
3	Operating indicator / dark on	GN
4	Signal indicator	YE
5	Operating indicator / light on	GN

Characteristic Curve



Release date: 2023-01-24 Date of issue: 2023-01-24 Filename: 295670-100110_eng.pdf

Accessories

	OMH-MLV12-HWG	Mounting bracket for series MLV12 sensors
	OMH-R200-01	Mounting aid for round steel ø 12 mm or sheet 1.5 mm ... 3 mm
	OMH-MLV12-HWK	Mounting bracket for series MLV12 sensors
	OMH-R20x-Quick-Mount	Quick mounting accessory
	ICE2-8IOL-G65L-V1D	EtherNet/IP IO-Link master with 8 inputs/outputs
	ICE3-8IOL-G65L-V1D	PROFINET IO IO-Link master with 8 inputs/outputs
	ICE2-8IOL-K45S-RJ45	EtherNet/IP IO-Link master with 8 inputs/outputs, DIN rail, screw terminal
	ICE3-8IOL-K45P-RJ45	PROFINET IO IO-Link master with 8 inputs/outputs, DIN rail, push-in terminals
	ICE3-8IOL-K45S-RJ45	PROFINET IO IO-Link master with 8 inputs/outputs, DIN rail, screw terminal
	IO-Link-Master02-USB	IO-Link master, supply via USB port or separate power supply, LED indicators, M12 plug for sensor connection
	ICE1-8IOL-G30L-V1D	Ethernet IO-Link module with 8 inputs/outputs
	ICE1-8IOL-G60L-V1D	Ethernet IO-Link module with 8 inputs/outputs
	ICE2-8IOL-K45P-RJ45	EtherNet/IP IO-Link master with 8 inputs/outputs, DIN rail, push-in connectors
	V31-GM-2M-PUR	Female cordset single-ended M8 straight A-coded, 4-pin, PUR cable grey
	V31-WM-2M-PUR	Female cordset single-ended M8 angled A-coded, 4-pin, PUR cable grey

Release date: 2023-01-24 Date of issue: 2023-01-24 Filename: 295670-100110_eng.pdf

Configuration

To unlock the adjustment functions, rotate the sensing range/sensitivity adjuster by more than 180°.

Sensing Range/Sensitivity

To increase the sensing range/sensitivity, rotate the sensing range/sensitivity adjuster clockwise.

To reduce the sensing range/sensitivity, rotate the sensing range/sensitivity adjuster counter-clockwise.

As soon as the end of the adjustment range is reached, the signal indicator flashes at 8 Hz.

Configuring Light On/Dark On

Press the light-on/dark-on changeover switch for more than 1 second (but less than 4 seconds). "Light on/dark on" mode changes and the relevant operating indicator lights up.

If you press the light-on/dark-on changeover switch for longer than 4 seconds, the "light on/dark on" mode will switch back to the original setting. The current status is activated when the light-on/dark-on changeover switch is released.

Restoring Factory Settings

Press the light-on/dark-on changeover switch for more than 10 seconds (but less than 30 seconds) until all LEDs go out. When the light-on/dark-on changeover switch is released, the signal indicator lights up. After 5 seconds, the sensor resumes operation with the factory settings.

The adjustment functions are locked after 5 minutes of inactivity. To unlock the adjustment functions, rotate the sensing range/sensitivity adjuster again by more than 180°.