



Distance sensor

OMT300-R201-2EP-IO-0,3M-V31



- Medium design with versatile mounting options
- Space-saving distance sensors in small standardized design
- Multi Pixel Technology (MPT) - exact and precise signal evaluation
- IO-Link interface for service and process data

Distance sensor



Function

The optical sensors in the series are the first devices to offer an end-to-end solution in a medium-sized standard design – from the thru-beam sensor through to the measuring distance sensor. As a result of this design, the sensors are able to perform practically all standard automation tasks.

The entire series enables sensors to communicate via IO-Link.

The DuraBeam laser sensors are durable and can be used in the same way as a standard sensor.

Multi Pixel Technology (MPT) ensures that the standard sensors are flexible and can be adapted to the application environment.

Dimensions

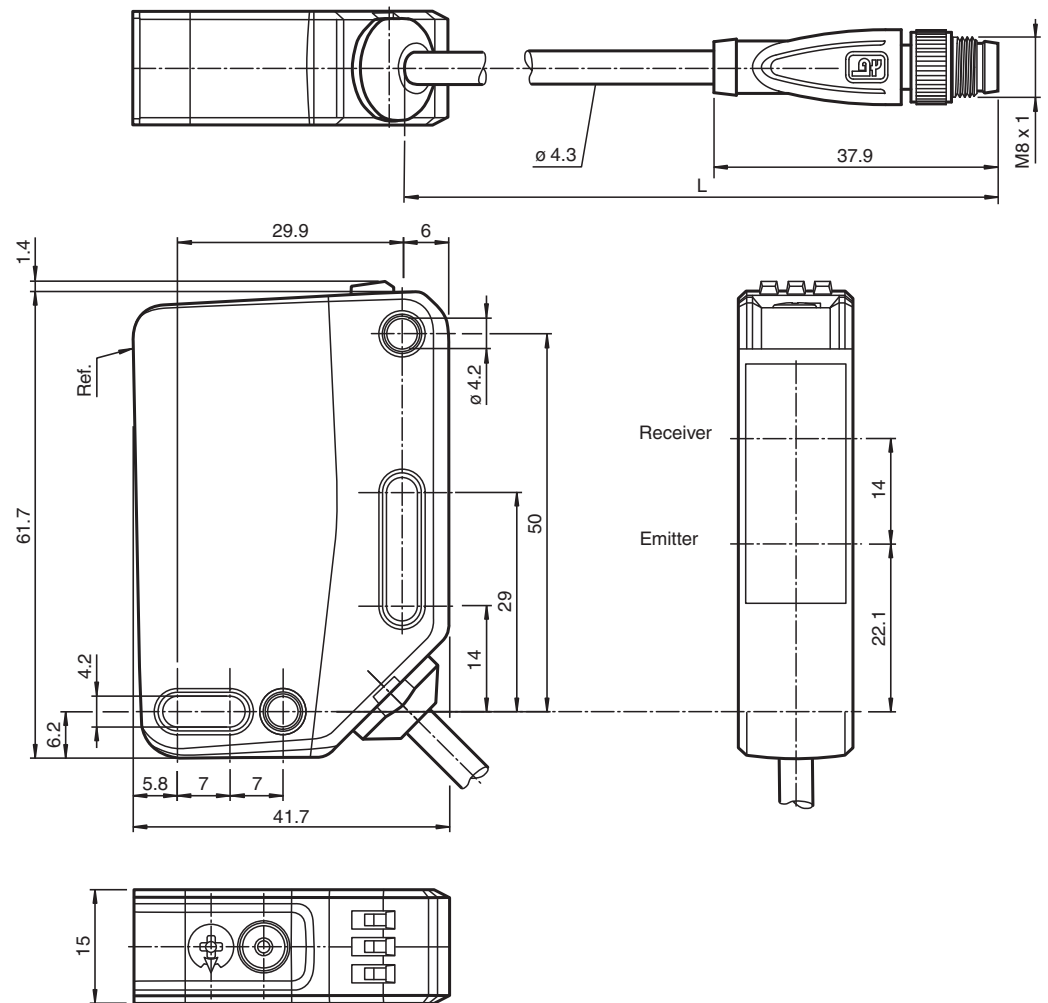

Technical Data

General specifications	
Measurement range	100 ... 300 mm
Reference target	standard white, 100 mm x 100 mm
Light source	LED
Light type	modulated visible red light
LED risk group labelling	exempt group
Angle deviation	max. +/- 1.5 °
Diameter of the light spot	approx. 8 mm at a distance of 300 mm
Opening angle	1.8 °
Ambient light limit	EN 60947-5-2 : 45000 Lux
Resolution	0.1 mm
Functional safety related parameters	
MTTF _d	600 a
Mission Time (T _M)	20 a
Diagnostic Coverage (DC)	0 %
Indicators/operating means	
Operation indicator	LED green: constantly on - power on flashing (4Hz) - short circuit flashing with short break (1 Hz) - IO-Link mode
Function indicator	LED yellow: constantly on - switch output active constantly off - switch output inactive

Technical Data

Control elements		Teach-In key
Control elements		5-step rotary switch for operating modes selection
Electrical specifications		
Operating voltage	U_B	10 ... 30 V DC
Ripple		max. 10 %
No-load supply current	I_0	< 25 mA at 24 V supply voltage
Protection class		III
Interface		
Interface type		IO-Link (via C/Q = pin 4)
IO-Link revision		1.1
Device profile		Identification and diagnosis Smart Sensor type 0/type 3.3
Device ID		0x111914 (1120532)
Transfer rate		COM2 (38.4 kBit/s)
Min. cycle time		3 ms
Process data width		Process data input 4 byte Process data output 2 bits
SIO mode support		yes
Compatible master port type		A
Output		
Switching type		The default setting is: C/Q - Pin4: NPN normally open, PNP normally closed, IO-Link Q2 - Pin2: NPN normally-open, PNP normally-closed
Signal output		2 push-pull (4 in 1) outputs, short-circuit protected, reverse polarity protected, overvoltage protected
Switching voltage		max. 30 V DC
Switching current		max. 100 mA , resistive load
Usage category		DC-12 and DC-13
Voltage drop	U_d	≤ 1.5 V DC
Response time		2 ms , see table 1
Conformity		
Communication interface		IEC 61131-9
Product standard		EN 60947-5-2
Measurement accuracy		
Temperature drift		0.05 %/K
Warm up time		5 min
Repeat accuracy		< 0.5 % , see table 1
Linearity error		0.5 %
Approvals and certificates		
UL approval		E87056 , cULus Listed , class 2 power supply , type rating 1
CCC approval		CCC approval / marking not required for products rated ≤ 36 V
Ambient conditions		
Ambient temperature		10 ... 60 °C (50 ... 140 °F)
Storage temperature		-40 ... 70 °C (-40 ... 158 °F)
Mechanical specifications		
Housing width		15 mm
Housing height		61.7 mm
Housing depth		41.7 mm
Degree of protection		IP67 / IP69 / IP69K
Connection		fixed cable 300 mm with M8 x 1 male connector; 4-pin
Material		
Housing		PC (Polycarbonate)
Optical face		PMMA
Mass		approx. 51 g
Cable length		0.3 m

Connection



Connection Assignment



Wire colors in accordance with EN 60947-5-2

- 1 | BN (brown)
- 2 | WH (white)
- 3 | BU (blue)
- 4 | BK (black)

Assembly

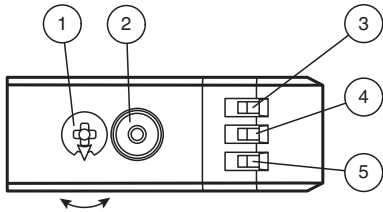

1	Mode rotary switch	
2	Teach-in button	
3	Switching output display Q2	YE
4	Switching output display Q1	YE
5	Operating indicator	GN

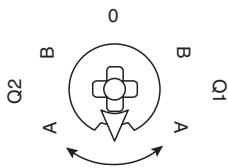













Q1B	Switching output 1/switch point B
Q1A	Switching output 1/switch point A
Q2A	Switching output 2/switch point A
Q2B	Switching output 2/switch point B
0	Keylock

Accessories

	OMH-RL31-02	Mounting bracket narrow
	OMH-RL31-03	Mounting bracket narrow
	OMH-RL31-04	Mounting aid for round steel ø 12 mm or sheet 1.5 mm ... 3 mm

Release date: 2023-01-16 Date of issue: 2023-01-16 Filename: 295670-100182_eng.pdf

Accessories

	OMH-RL31-07	Mounting bracket including adjustment
	OMH-R20x-Quick-Mount	Quick mounting accessory
	ICE2-8IOL-G65L-V1D	EtherNet/IP IO-Link master with 8 inputs/outputs
	ICE3-8IOL-G65L-V1D	PROFINET IO IO-Link master with 8 inputs/outputs
	ICE2-8IOL-K45S-RJ45	EtherNet/IP IO-Link master with 8 inputs/outputs, DIN rail, screw terminal
	ICE3-8IOL-K45P-RJ45	PROFINET IO IO-Link master with 8 inputs/outputs, DIN rail, push-in terminals
	ICE3-8IOL-K45S-RJ45	PROFINET IO IO-Link master with 8 inputs/outputs, DIN rail, screw terminal
	IO-Link-Master02-USB	IO-Link master, supply via USB port or separate power supply, LED indicators, M12 plug for sensor connection
	ICE1-8IOL-G30L-V1D	Ethernet IO-Link module with 8 inputs/outputs
	ICE1-8IOL-G60L-V1D	Ethernet IO-Link module with 8 inputs/outputs
	ICE2-8IOL-K45P-RJ45	EtherNet/IP IO-Link master with 8 inputs/outputs, DIN rail, push-in connectors
	V31-GM-2M-PUR	Female cordset single-ended M8 straight A-coded, 4-pin, PUR cable grey
	V31-WM-2M-PUR	Female cordset single-ended M8 angled A-coded, 4-pin, PUR cable grey

Technical Features

Table 1: Information on Measured Value Filters

Measured value filter	1-way	2-way	4-way	16-way	64-way	256-way
Filter						
Response time (ms)	2	4	8	32	128	512
Repeatability (%)	< 0.5 %					

Commissioning

Teach-In (TI)

Use the rotary switch for switching signal **Q1** or **Q2** to select the relevant switching threshold A and/or B to teach in.

- The yellow LEDs indicate the current state of the selected output.

To teach in a switching threshold, press and hold the "TI" button for approximately 1 s, until the yellow and green LEDs flash in phase. Teach-in starts when the "TI" button is released.

- Teach-in successful: the yellow and green LEDs flash alternately at 2.5 Hz.
- Teach-in unsuccessful: the yellow and green LEDs quickly flash alternately at 8 Hz.

After an unsuccessful Teach-in, the sensor continues to operate with the previous valid setting after the relevant visual fault signal is issued.

Set switching mode: you can define different switching modes by teaching in the relevant distance data for switching thresholds A and B.

1. Single point mode:

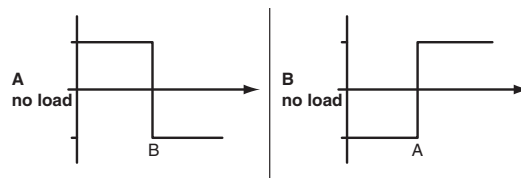

2. Window mode:

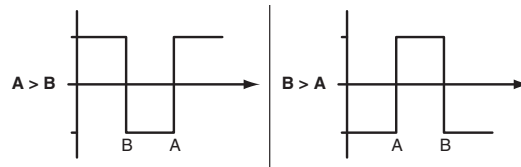

Teach in switching thresholds: you can teach in or overwrite a taught-in switching threshold at any time. To do this, press the "TI" button again.

Reset a value: you can reset a taught-in value. To do this, press the "TI" button for > 4 s, until the yellow and green LEDs go out. The reset process itself starts when the "TI" button is released.

- Reset successful: the yellow and green LEDs flash alternately at 2.5 Hz.

Resetting to Factory Settings

To revert back to factory settings, press the "TI" button for > 10 s with the rotary switch set to position "O," until the yellow and green LEDs go out at the same time. The reset process itself starts when the "TI" button is released.

- Reset to factory settings successful: the yellow and green LEDs light up at the same time. The sensor then continues to operate with factory settings.

OMT

- Factory setting for switching signal Q1: Switching signal is high active, window mode
- Factory setting for switching signal Q2: Switching signal is high active, window mode

Configuration

Setting different operating modes via the IO-Link interface

The devices are equipped with an IO-Link interface as standard for diagnostics and parameterization tasks to ensure optimum

Release date: 2023-01-16 Date of issue: 2023-01-16 Filename: 295670-100182_eng.pdf

adjustment of the sensors to the relevant application.

Single point mode operating mode (one switch point):

- "Detection of objects irrespective of type and color in a defined detection range. Objects in the background are suppressed.
- "The switch point corresponds exactly to the set point.



Window mode operating mode (two switch points):

- Detection of objects irrespective of type and color in a defined detection range. Reliable detection when object leaves the detection range.
- Window mode with two switch points.



Center window mode operating mode (one switch point):

- Detection of objects irrespective of type and color in a defined detection range. Sets a defined window around a given object. Objects outside this window are not detected.
- Window mode with one switch point.



Two point mode operating mode (hysteresis operating mode):

- Detection of objects irrespective of type and color between a defined switch-on and switch-off point.

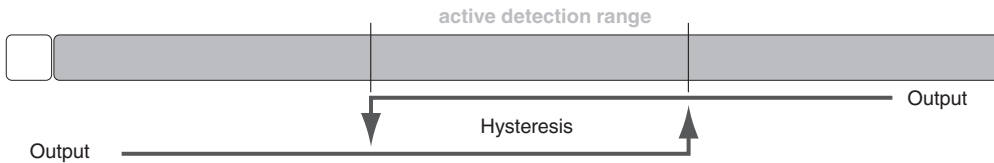

Inactive operating mode:

- Evaluation of switching signals is deactivated.

The associated IODD device description file can be found in the download area at www.pepperl-fuchs.com.