



Triangulation sensor (BGS)

OBT600-R200-2EP-IO-0,3M-V31-L



- Medium design with versatile mounting options
- DuraBeam Laser Sensors - durable and employable like an LED
- Extended temperature range
-40 °C ... 60 °C
- High degree of protection IP69K
- IO-Link interface for service and process data

Laser diffuse mode sensor with adjustable background suppression



Function

The optical sensors in the series are the first devices to offer an end-to-end solution in a medium-sized standard design – from the thru-beam sensor through to the measuring distance sensor. As a result of this design, the sensors are able to perform practically all standard automation tasks.

The entire series enables sensors to communicate via IO-Link.

The DuraBeam laser sensors are durable and can be used in the same way as a standard sensor.

Multi Pixel Technology (MPT) ensures that the standard sensors are flexible and can be adapted to the application environment.

Dimensions

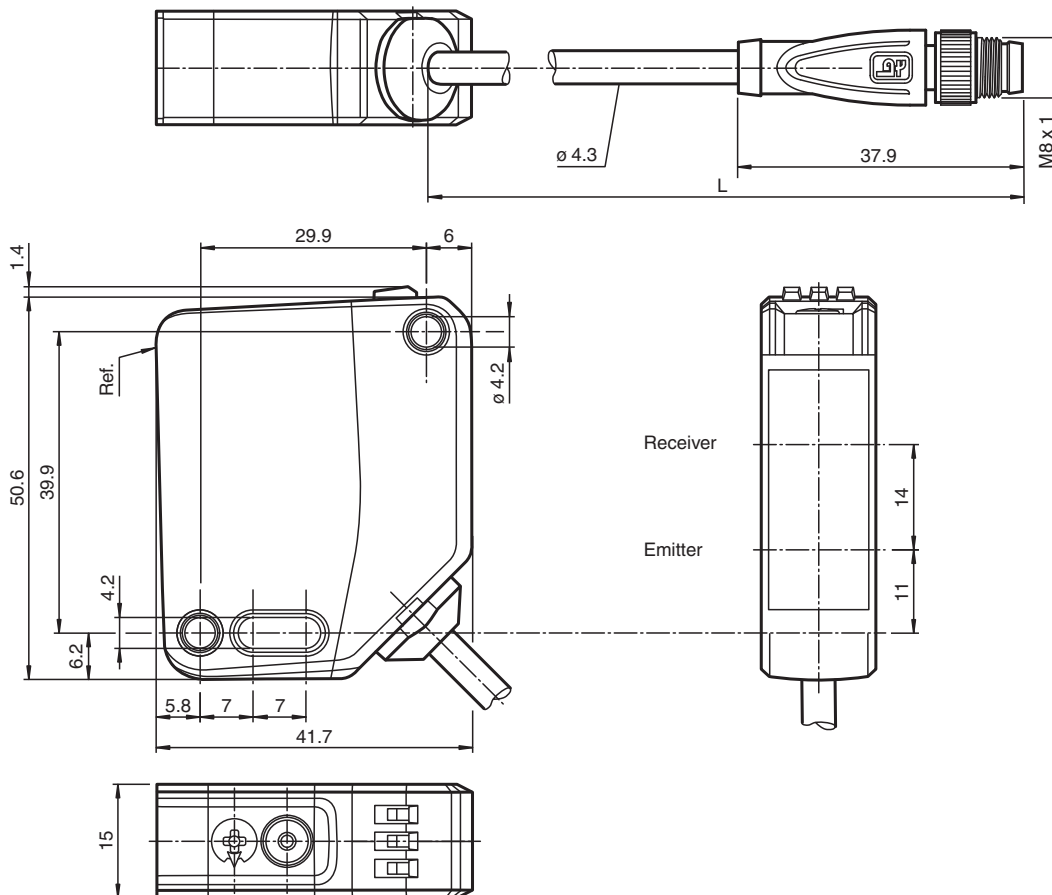

Release date: 2025-01-17 Date of issue: 2025-01-17 Filename: 295670-100226_eng.pdf

Technical Data

General specifications			
Detection range			40 ... 600 mm
Detection range min.			40 ... 90 mm
Detection range max.			40 ... 600 mm
Adjustment range			90 ... 600 mm
Reference target			standard white, 100 mm x 100 mm
Light source			laser diode
Light type			modulated visible red light
Laser nominal ratings			
Note			LASER LIGHT , DO NOT STARE INTO BEAM
Laser class			1
Wave length			680 nm
Beam divergence			> 5 mrad, d63 < 2,8 mm in the range of 350 mm ... 800 mm
Pulse length			3 µs
Repetition rate			approx. 13 kHz
max. pulse energy			10.4 nJ
Black-white difference (6 %/90 %)			< 5 % at 300 mm
Diameter of the light spot			approx. 2.5 mm at a distance of 600 mm
Opening angle			approx. 0.3 °
Ambient light limit			EN 60947-5-2 : 70000 Lux
Functional safety related parameters			
MTTF _d			560 a
Mission Time (T _M)			20 a
Diagnostic Coverage (DC)			0 %
Indicators/operating means			
Operation indicator			LED green: constantly on - power on flashing (4Hz) - short circuit flashing with short break (1 Hz) - IO-Link mode
Function indicator			LED yellow: constantly on - object detected constantly off - object not detected
Control elements			Light-on/dark-on changeover switch
Control elements			Sensing range adjuster
Electrical specifications			
Operating voltage	U _B		10 ... 30 V DC
Ripple			max. 10 %
No-load supply current	I ₀		< 15 mA at 24 V supply voltage
Protection class			III
Interface			
Interface type			IO-Link (via C/Q = pin 4)
IO-Link revision			1.1
Device profile			Identification and diagnosis Smart Sensor type 2.4
Device ID			0x111603 (1119747)
Transfer rate			COM2 (38.4 kBit/s)
Min. cycle time			2.3 ms
Process data width			Process data input 1 Bit Process data output 2 Bit
SIO mode support			yes
Compatible master port type			A
Output			
Switching type			The switching type of the sensor is adjustable. The default setting is: C/Q - Pin4: NPN normally open / light-on, PNP normally closed / dark-on, IO-Link /Q - Pin2: NPN normally closed / dark-on, PNP normally open / light-on
Signal output			2 push-pull (4 in 1) outputs, short-circuit protected, reverse polarity protected, overvoltage protected

Release date: 2025-01-17 Date of issue: 2025-01-17 Filename: 295670-100226_eng.pdf

Technical Data

Switching voltage		max. 30 V DC
Switching current		max. 100 mA , resistive load
Usage category		DC-12 and DC-13
Voltage drop	U_d	≤ 1.5 V DC
Switching frequency	f	1650 Hz
Response time		300 μ s
Conformity		
Communication interface		IEC 61131-9
Product standard		EN 60947-5-2
Laser safety		EN 60825-1:2014
Approvals and certificates		
UL approval		E87056 , cULus Listed , class 2 power supply , type rating 1
CCC approval		CCC approval / marking not required for products rated ≤ 36 V
FDA approval		IEC 60825-1:2014 Complies with 21 CFR 1040.10 and 1040.11 except for conformance with IEC 60825-1 Ed. 3 as described in Laser Notice 56, dated May 8, 2019.
Ambient conditions		
Ambient temperature		-40 ... 60 °C (-40 ... 140 °F) , cable, fixed installation -20 ... 60 °C (-4 ... 140 °F) , movable cable not appropriate for conveyor chains
Storage temperature		-40 ... 70 °C (-40 ... 158 °F)
Mechanical specifications		
Degree of protection		IP67 / IP69 / IP69K
Connection		fixed cable 300 mm with M8 x 1 male connector; 4-pin
Material		
Housing		PC (Polycarbonate)
Optical face		PMMA
Mass		approx. 43 g
Dimensions		
Height		50.6 mm
Width		15 mm
Depth		41.7 mm
Cable length		0.3 m

Connection Assignment

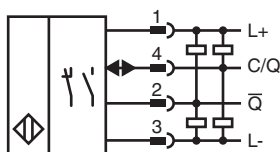

Connection Assignment



Release date: 2025-01-17 Date of issue: 2025-01-17 Filename: 295670-100226_eng.pdf

Connection Assignment

Wire colors in accordance with EN 60947-5-2

1	BN	(brown)
2	WH	(white)
3	BU	(blue)
4	BK	(black)

Assembly

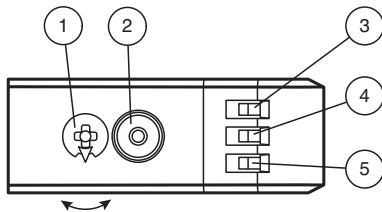

1	Sensitivity adjustment	
2	Light-on / dark-on changeover switch	
3	Operating indicator / dark on	GN
4	Signal indicator	YE
5	Operating indicator / light on	GN

Characteristic Curve

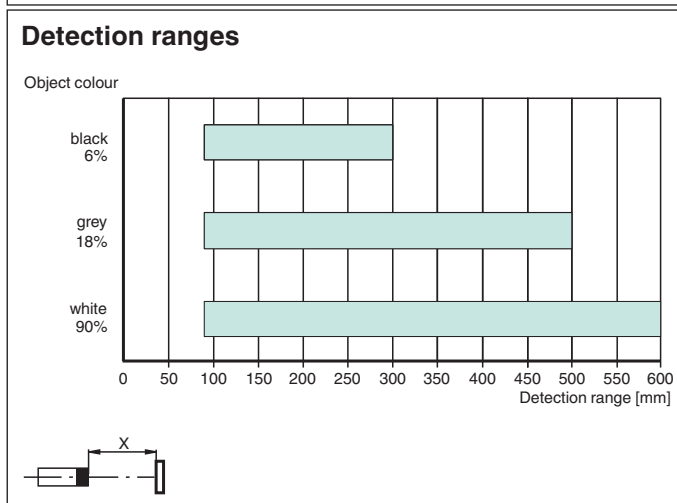
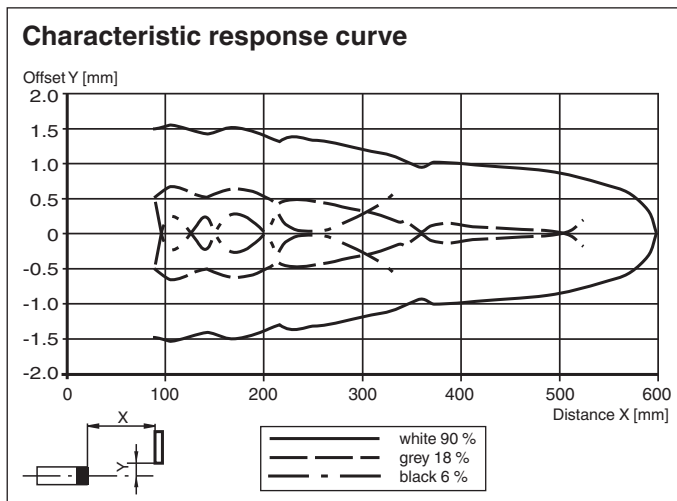

Release date: 2025-01-17 Date of issue: 2025-01-17 Filename: 295670-100226_eng.pdf

Characteristic Curve

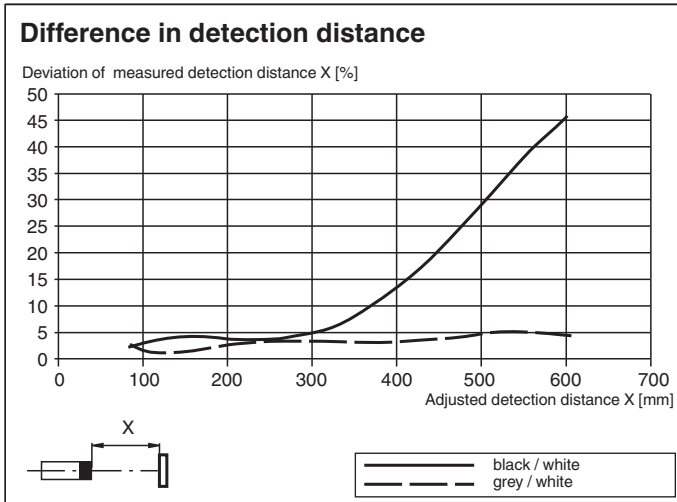

Safety Information

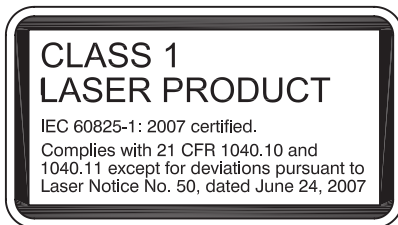

Release date: 2025-01-17 Date of issue: 2025-01-17 Filename: 295670-100226_eng.pdf

Configuration

To unlock the adjustment functions, rotate the sensing range/sensitivity adjuster by more than 180°.

Sensing Range/Sensitivity

To increase the sensing range/sensitivity, rotate the sensing range/sensitivity adjuster clockwise.

To reduce the sensing range/sensitivity, rotate the sensing range/sensitivity adjuster counter-clockwise.

As soon as the end of the adjustment range is reached, the signal indicator flashes at 8 Hz.

Configuring Light On/Dark On

Press the light-on/dark-on changeover switch for more than 1 second (but less than 4 seconds). "Light on/dark on" mode changes and the relevant operating indicator lights up.

If you press the light-on/dark-on changeover switch for longer than 4 seconds, the "light on/dark on" mode will switch back to the original setting. The current status is activated when the light-on/dark-on changeover switch is released.

Restoring Factory Settings

Press the light-on/dark-on changeover switch for more than 10 seconds (but less than 30 seconds) until all LEDs go out. When the light-on/dark-on changeover switch is released, the signal indicator lights up. After 5 seconds, the sensor resumes operation with the factory settings.

The adjustment functions are locked after 5 minutes of inactivity. To unlock the adjustment functions, rotate the sensing range/sensitivity adjuster again by more than 180°.