



Triangulation sensor (BGE) OBT600-R201-2EP-IO-1T-L-Y0250



- Medium design with versatile mounting options
- Secure and gapless detection, even near the surface through background evaluation
- DuraBeam Laser Sensors - durable and employable like an LED
- Extended temperature range
-40 °C ... 60 °C
- High degree of protection IP69K
- IO-Link interface for service and process data

Laser diffuse mode sensor with background evaluation



IO-Link

Function

The optical sensors in the series are the first devices to offer an end-to-end solution in a medium-sized standard design – from the thru-beam sensor through to the measuring distance sensor. As a result of this design, the sensors are able to perform practically all standard automation tasks.

The entire series enables sensors to communicate via IO-Link.

The DuraBeam laser sensors are durable and can be used in the same way as a standard sensor.

Multi Pixel Technology (MPT) ensures that the standard sensors are flexible and can be adapted to the application environment.

Dimensions

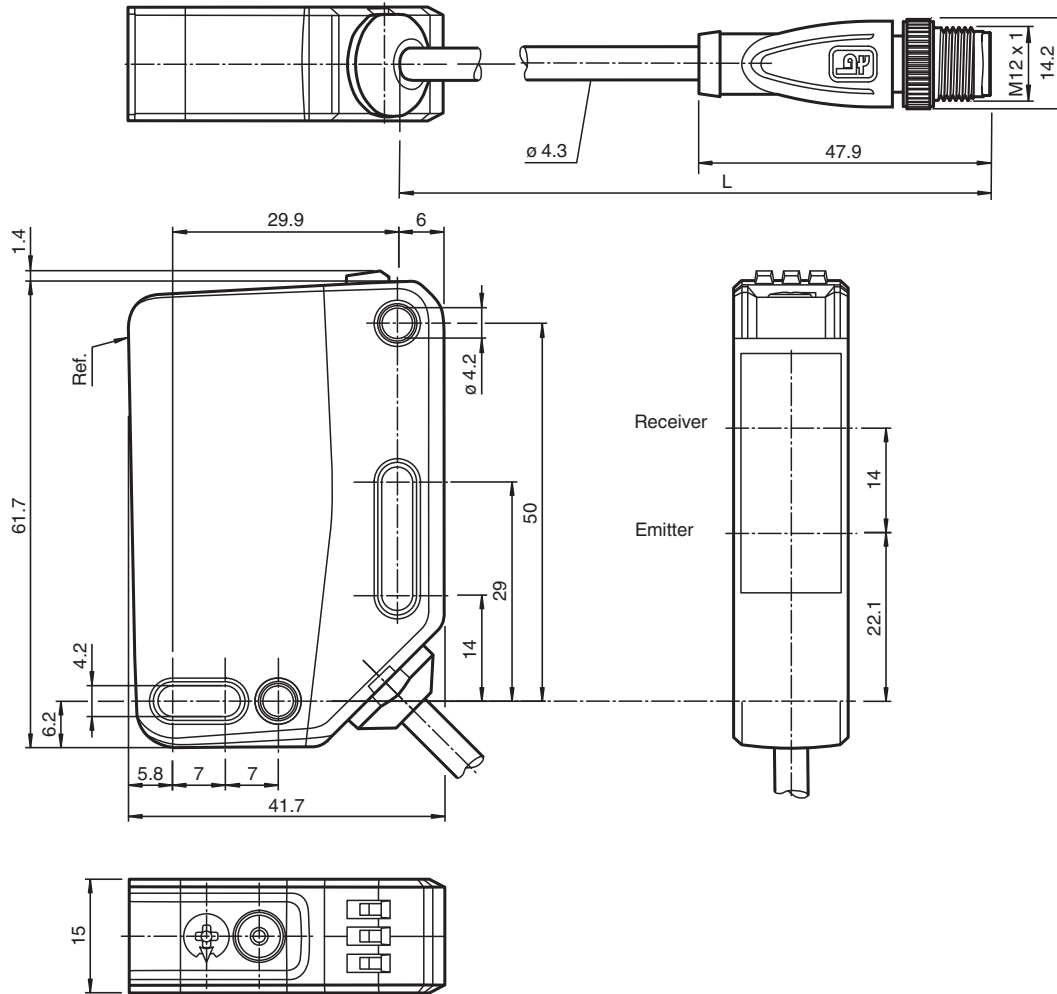

Technical Data

General specifications

Detection range	40 ... 600 mm
Detection range min.	40 ... 90 mm
Detection range max.	40 ... 600 mm
Adjustment range	90 ... 600 mm
Reference target	standard white, 100 mm x 100 mm
Light source	laser diode
Light type	modulated visible red light
Laser nominal ratings	
Note	LASER LIGHT , DO NOT STARE INTO BEAM
Laser class	1
Wave length	680 nm
Beam divergence	> 5 mrad, d63 < 2,8 mm in the range of 350 mm ... 800 mm
Pulse length	3 μs
Repetition rate	approx. 13 kHz
max. pulse energy	10.4 nJ
Black-white difference (6 %/90 %)	< 5 % at 300 mm
Diameter of the light spot	approx. 2.5 mm at a distance of 600 mm
Opening angle	approx. 0.3 °
Ambient light limit	EN 60947-5-2 : 70000 Lux

Functional safety related parameters

Release date: 2025-01-17 Date of issue: 2025-01-17 Filename: 295670-100250_eng.pdf

Technical Data

MTTF _d		560 a
Mission Time (T _M)		20 a
Diagnostic Coverage (DC)		0 %
Indicators/operating means		
Operation indicator		LED green: constantly on - power on flashing (4Hz) - short circuit flashing with short break (1 Hz) - IO-Link mode
Function indicator		LED yellow: constantly on - background detected (object not detected) constantly off - object detected
Control elements		Light-on/dark-on changeover switch
Control elements		Sensing range adjuster
Electrical specifications		
Operating voltage	U _B	10 ... 30 V DC
Ripple		max. 10 %
No-load supply current	I ₀	< 20 mA at 24 V supply voltage
Protection class		III
Interface		
Interface type		IO-Link (via C/Q = pin 4)
IO-Link revision		1.1
Device profile		Identification and diagnosis Smart Sensor type 2.4
Device ID		0x111713 (1120019)
Transfer rate		COM2 (38.4 kBit/s)
Min. cycle time		2.3 ms
Process data width		Process data input 1 Bit Process data output 2 Bit
SIO mode support		yes
Compatible master port type		A
Output		
Switching type		The switching type of the sensor is adjustable. The default setting is: C/Q - Pin4: NPN normally open / dark-on, PNP normally closed / light-on, IO-Link /Q - Pin2: NPN normally closed / light-on, PNP normally open / dark-on
Signal output		2 push-pull (4 in 1) outputs, short-circuit protected, reverse polarity protected, overvoltage protected
Switching voltage		max. 30 V DC
Switching current		max. 100 mA , resistive load
Usage category		DC-12 and DC-13
Voltage drop	U _d	≤ 1.5 V DC
Switching frequency	f	1650 Hz
Response time		300 μs
Conformity		
Communication interface		IEC 61131-9
Product standard		EN 60947-5-2
Laser safety		EN 60825-1:2014
Approvals and certificates		
UL approval		E87056 , cULus Listed , class 2 power supply , type rating 1
CCC approval		CCC approval / marking not required for products rated ≤36 V
FDA approval		IEC 60825-1:2014 Complies with 21 CFR 1040.10 and 1040.11 except for conformance with IEC 60825-1 Ed. 3 as described in Laser Notice 56, dated May 8, 2019.
Ambient conditions		
Ambient temperature		-40 ... 60 °C (-40 ... 140 °F) , cable, fixed installation -20 ... 60 °C (-4 ... 140 °F) , movable cable not appropriate for conveyor chains
Storage temperature		-40 ... 70 °C (-40 ... 158 °F)
Mechanical specifications		
Degree of protection		IP67 / IP69 / IP69K

Technical Data

Connection	300 mm fixed cable with M12 x 1, 4-pin connector
Material	
Housing	PC (Polycarbonate)
Optical face	PMMA
Mass	approx. 55 g
Dimensions	
Height	61.7 mm
Width	15 mm
Depth	41.7 mm
Cable length	0.3 m

Connection Assignment

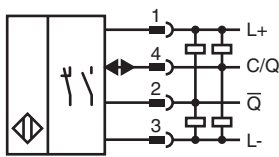

Connection Assignment

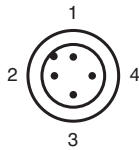

Wire colors in accordance with EN 60947-5-2

- | | | |
|---|----|---------|
| 1 | BN | (brown) |
| 2 | WH | (white) |
| 3 | BU | (blue) |
| 4 | BK | (black) |

Assembly

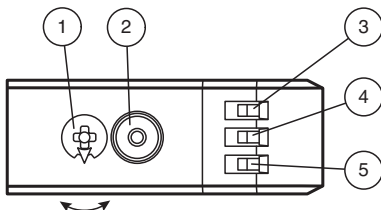

1	Sensitivity adjustment	
2	Light-on / dark-on changeover switch	
3	Operating indicator / dark on	GN
4	Signal indicator	YE
5	Operating indicator / light on	GN

Release date: 2025-01-17 Date of issue: 2025-01-17 Filename: 295670-100250_eng.pdf

Characteristic Curve

Minimum object height (typical)

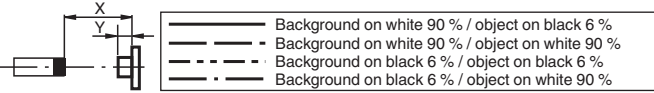
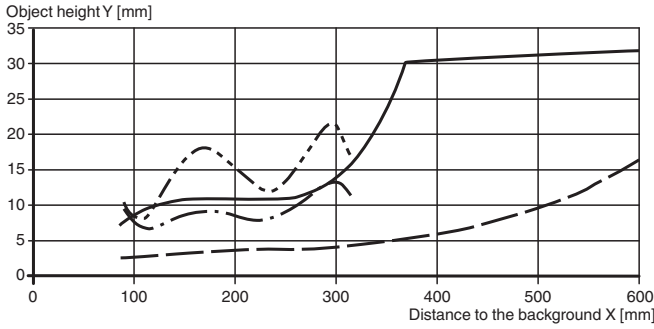

Safety Information

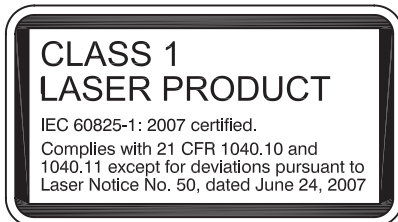

Release date: 2025-01-17 Date of issue: 2025-01-17 Filename: 295670-100250_eng.pdf

Configuration

To unlock the adjustment functions, rotate the sensing range/sensitivity adjuster by more than 180°.

Sensing Range/Sensitivity

To increase the sensing range/sensitivity, rotate the sensing range/sensitivity adjuster clockwise.

To reduce the sensing range/sensitivity, rotate the sensing range/sensitivity adjuster counter-clockwise.

As soon as the end of the adjustment range is reached, the signal indicator flashes at 8 Hz.

Configuring Light On/Dark On

Press the light-on/dark-on changeover switch for more than 1 second (but less than 4 seconds). "Light on/dark on" mode changes and the relevant operating indicator lights up.

If you press the light-on/dark-on changeover switch for longer than 4 seconds, the "light on/dark on" mode will switch back to the original setting. The current status is activated when the light-on/dark-on changeover switch is released.

Restoring Factory Settings

Press the light-on/dark-on changeover switch for more than 10 seconds (but less than 30 seconds) until all LEDs go out. When the light-on/dark-on changeover switch is released, the signal indicator lights up. After 5 seconds, the sensor resumes operation with the factory settings.

The adjustment functions are locked after 5 minutes of inactivity. To unlock the adjustment functions, rotate the sensing range/sensitivity adjuster again by more than 180°.