



Distance sensor

OMT300-R201-IEP-IO-0,3M-V31-L



- Medium design with versatile mounting options
- Space-saving distance sensors in small standardized design
- Multi Pixel Technology (MPT) - exact and precise signal evaluation
- IO-Link interface for service and process data
- Analog output 4 ... 20 mA

Distance sensor



IO-Link

Function

The optical sensors in the series are the first devices to offer an end-to-end solution in a medium-sized standard design – from the thru-beam sensor through to the measuring distance sensor. As a result of this design, the sensors are able to perform practically all standard automation tasks.

The entire series enables sensors to communicate via IO-Link.

The DuraBeam laser sensors are durable and can be used in the same way as a standard sensor.

Multi Pixel Technology (MPT) ensures that the standard sensors are flexible and can be adapted to the application environment.

Dimensions

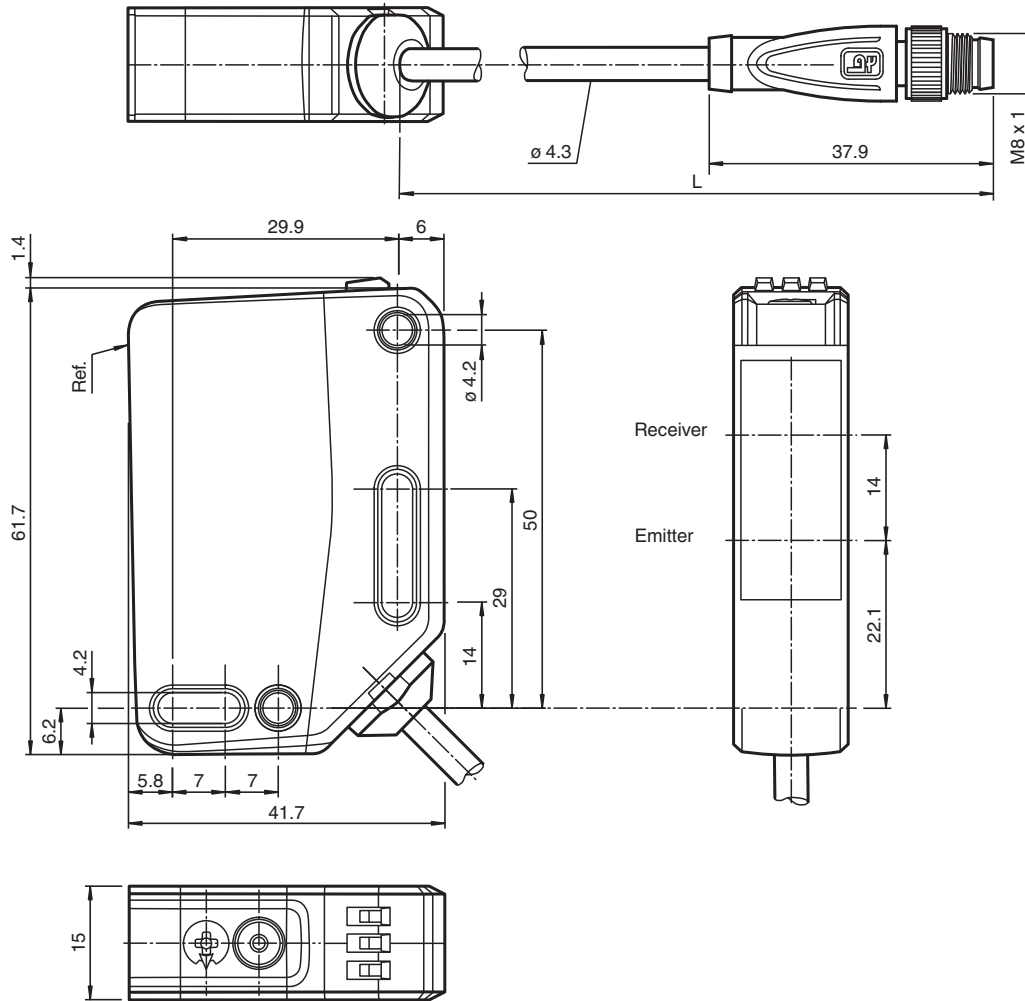

Technical Data

General specifications

Measuring range	100 ... 300 mm
Reference target	standard white, 100 mm x 100 mm
Light source	laser diode
Light type	modulated visible red light
Laser nominal ratings	
Note	LASER LIGHT , DO NOT STARE INTO BEAM
Laser class	1
Wave length	680 nm
Beam divergence	> 5 mrad, $d_{63} < 2,8$ mm in the range of 350 mm ... 800 mm
Pulse length	5.5 μ s
Repetition rate	approx. 2.4 kHz
max. pulse energy	< 40 nJ
Angle deviation	max. +/- 1.5 °
Diameter of the light spot	approx. 3 mm at a distance of 300 mm
Opening angle	approx. 0.3 °
Ambient light limit	EN 60947-5-2 : 45000 Lux
Resolution	0.1 mm

Functional safety related parameters

MTTF _d	470 a
Mission Time (T _M)	20 a

Technical Data

Diagnostic Coverage (DC)		0 %
Indicators/operating means		
Operation indicator		LED green: constantly on - power on flashing (4Hz) - short circuit flashing with short break (1 Hz) - IO-Link mode
Function indicator		LED yellow: constantly on - switch output active constantly off - switch output inactive
Control elements		Teach-In key
Control elements		5-step rotary switch for operating modes selection
Electrical specifications		
Operating voltage	U_B	18 ... 30 V DC
Ripple		max. 10 %
No-load supply current	I_0	< 18 mA at 24 V supply voltage
Protection class		III
Interface		
Interface type		IO-Link (via C/Q = pin 4)
IO-Link revision		1.1
Device profile		Identification and diagnosis Smart Sensor type 0/type 3.3
Device ID		0x11191B (1120539)
Transfer rate		COM2 (38.4 kBit/s)
Min. cycle time		3 ms
Process data width		Process data input 4 byte Process data output 2 bits
SIO mode support		yes
Compatible master port type		A
Output		
Switching type		The default setting is: C/Q - Pin4: NPN normally open, PNP normally closed, IO-Link I—Pin2: analog output 4...20 mA
Signal output		1 push-pull output , 1 analog output , short-circuit-proof, reverse polarity protection, surge-proof
Switching voltage		max. 30 V DC
Switching current		max. 100 mA , resistive load
Usage category		DC-12 and DC-13
Voltage drop	U_d	≤ 1.5 V DC
Response time		2 ms
Analog output		
Output type		1 current output: 4 ... 20 mA
Load resistor		> 1 k Ω voltage output ; $\leq 470 \Omega$ current output
Recovery time		2 ms
Conformity		
Communication interface		IEC 61131-9
Product standard		EN 60947-5-2
Laser safety		EN 60825-1:2014
Measurement accuracy		
Temperature drift		0.05 %/K
Warm up time		5 min
Repeat accuracy		< 0.5 %
Linearity error		0.5 %
Approvals and certificates		
UL approval		E87056 , cULus Listed , class 2 power supply , type rating 1
CCC approval		CCC approval / marking not required for products rated ≤ 36 V

Technical Data

FDA approval	IEC 60825-1:2014 Complies with 21 CFR 1040.10 and 1040.11 except for conformance with IEC 60825-1 Ed. 3 as described in Laser Notice 56, dated May 8, 2019.
Ambient conditions	
Ambient temperature	10 ... 50 °C (50 ... 122 °F)
Storage temperature	-40 ... 70 °C (-40 ... 158 °F)
Mechanical specifications	
Degree of protection	IP67 / IP69 / IP69K
Connection	fixed cable 300 mm with M8 x 1 male connector; 4-pin
Material	
Housing	PC (Polycarbonate)
Optical face	PMMA
Mass	approx. 51 g
Dimensions	
Height	61.7 mm
Width	15 mm
Depth	41.7 mm
Cable length	0.3 m

Connection

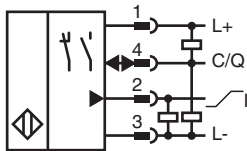

Connection Assignment



Wire colors in accordance with EN 60947-5-2

1	BN	(brown)
2	WH	(white)
3	BU	(blue)
4	BK	(black)

Assembly

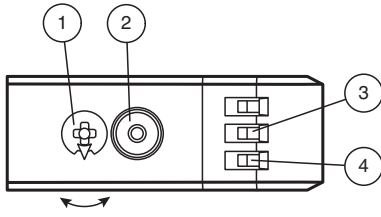

1	Mode rotary switch	
2	Teach-in button	
3	Switching output display Q1	YE
4	Operating indicator	GN

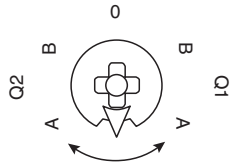

Q1B	Switching output/switch point B
Q1A	Switching output/switch point A
Q2A	Analog output/value A
Q2B	Analog output/value B
0	Keylock

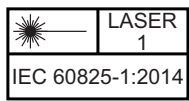

Release date: 2025-01-17 Date of issue: 2025-01-17 Filename: 295670-100356_eng.pdf

Settings

Teach-In (TI)

Use the rotary switch for switching signal **Q1** to select the relevant switching threshold A and/or B to teach in.

- The yellow LEDs indicate the current state of the selected output.

To teach in a switching threshold, press and hold the "TI" button for approximately 1 s, until the yellow and green LEDs flash in phase. Teach-in starts when the "TI" button is released.

- Teach-in successful: the yellow and green LEDs flash alternately at 2.5 Hz.
- Teach-in unsuccessful: the yellow and green LEDs quickly flash alternately at 8 Hz.

After an unsuccessful Teach-in, the sensor continues to operate with the previous valid setting after the relevant visual fault signal is issued.

Set switching mode: you can define different switching modes by teaching in the relevant distance data for switching thresholds A and B.

1. Single point mode:

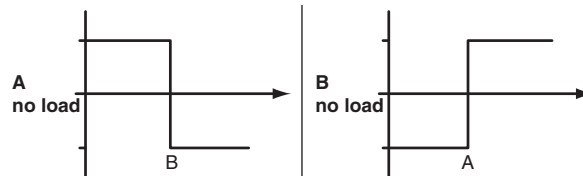

2. Window mode:

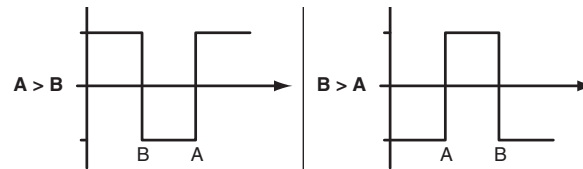

Teach in switching thresholds: you can teach in or overwrite a taught-in switching threshold at any time. To do this, press the "TI" button again.

Reset a value: you can reset a taught-in value. To do this, press the "TI" button for > 4 s, until the yellow and green LEDs go out. The reset process itself starts when the "TI" button is released.

- Reset successful: the yellow and green LEDs flash alternately at 2.5 Hz.

Minimum and maximum values for the analog output Q2 are taught in and deleted in the same way as those for the switching output.

The following applies:

A = Minimum voltage/current

B = Maximum voltage/current

Resetting to Factory Settings

To revert back to factory settings, press the "TI" button for > 10 s with the rotary switch set to position "O," until the yellow and green LEDs go out at the same time. The reset process itself starts when the "TI" button is released.

- Reset to factory settings successful: the yellow and green LEDs light up at the same time. The sensor then continues to operate with factory settings.

OMT-IEP

- Factory setting for switching signal Q1:
Switching signal is high active, window mode
- Analog output: current output, 4 mA ... 20 mA absolute mode

OMT-UEP

- Factory setting for switching signal Q1:
Switching signal is high active, window mode
- Analog output: voltage output, 0 V ... 10 V absolute mode

Analog output

The analog output type can be configured as voltage or current output via IO-Link.

The following output types are available:

- Analog output 0 mA ... 20 mA
- Analog output 4 mA ... 20 mA
- Analog output 0 V ... 10 V

The following operating modes are available:

- Absolute mode (default setting)
- Normalized mode
- Rising slope
- Falling slope

The following substitute values can optionally be configured:

- No substitute values used (default setting)
- Substitute value for "no measured value" used
- Substitute value for "no measured value" and "Measuring overrange" used

The sensor's tolerances are based on the digital process data.

Absolute mode (default setting, A and B = deleted)

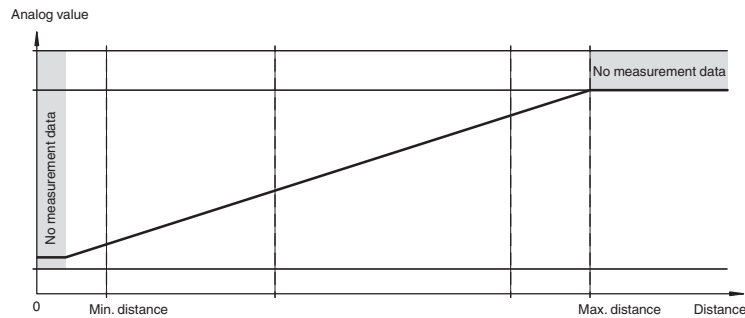

Normal mode (A and B without teach-in / deleted)

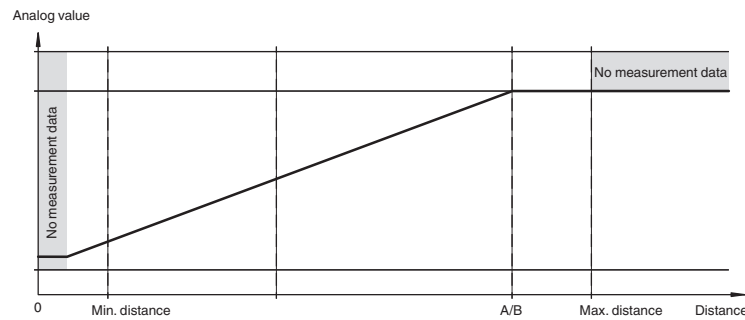

Rising slope (A < B)

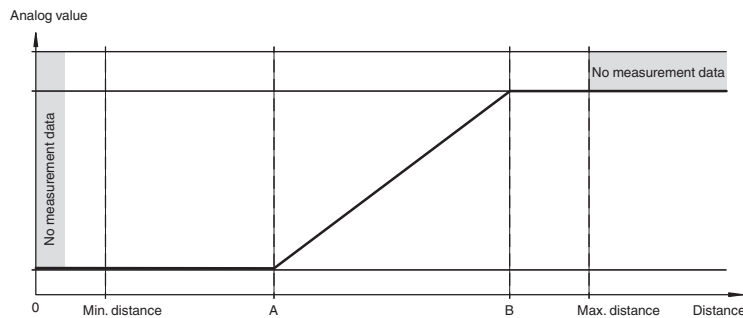

Release date: 2025-01-17 Date of issue: 2025-01-17 Filename: 295670-100356_eng.pdf

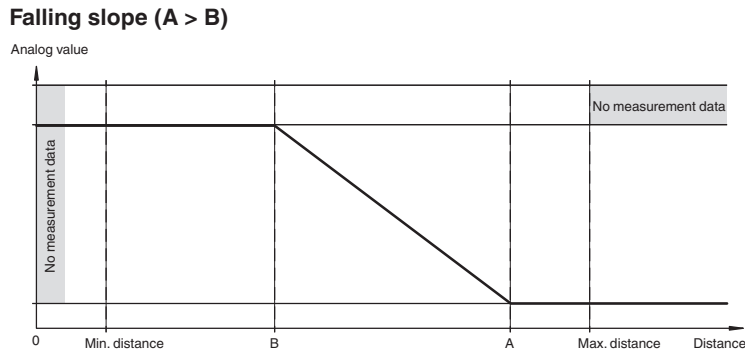

Configuration

Setting different operating modes via the IO-Link interface

The devices are equipped with an IO-Link interface as standard for diagnostics and parameterization tasks to ensure optimum adjustment of the sensors to the relevant application.

Single point mode operating mode (one switch point):

- "Detection of objects irrespective of type and color in a defined detection range. Objects in the background are suppressed.
- "The switch point corresponds exactly to the set point.



Window mode operating mode (two switch points):

- Detection of objects irrespective of type and color in a defined detection range. Reliable detection when object leaves the detection range.
- Window mode with two switch points.



Center window mode operating mode (one switch point):

- Detection of objects irrespective of type and color in a defined detection range. Sets a defined window around a given object. Objects outside this window are not detected.
- Window mode with one switch point.



Two point mode operating mode (hysteresis operating mode):

- Detection of objects irrespective of type and color between a defined switch-on and switch-off point.

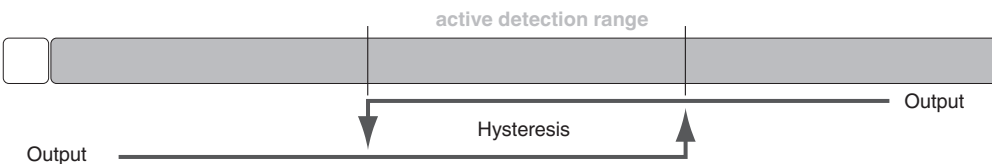

Inactive operating mode:

- Evaluation of switching signals is deactivated.

The associated IODD device description file can be found in the download area at www.pepperl-fuchs.com.

Release date: 2025-01-17 Date of issue: 2025-01-17 Filename: 295670-100356_eng.pdf