



## Distance sensor

### OMD10M-R200-2EP-IO-0,3M-V1-L



- Medium design with versatile mounting options
- Space-saving distance sensors in small standardized design
- Measuring method PRT (Pulse Ranging Technology)
- IO-Link interface for service and process data
- Red laser light, laser class 1

Universal distance sensor, measurement to object, IO-Link interface, measuring method PRT, measuring range up to 10 m, red laser light, laser class 1, push-pull output, fixed cable with M12 plug



**IO-Link**

## Function

The optical sensors in the series are the first devices to offer an end-to-end solution in a medium-sized standard design – from the thru-beam sensor through to the measuring distance sensor. As a result of this design, the sensors are able to perform practically all standard automation tasks.

The entire series enables sensors to communicate via IO-Link.

The distance sensor is based on pulse ranging technology (PRT) by Pepperl+Fuchs.

For small and large ranges, these distance sensors are very precise which makes them ideally suitable for positioning tasks. The red laser diode is clearly visible, allowing direct alignment of the device for reliable operation.

## Application

- Precise positioning of stock feeders
- Precise and rapid positioning of moving carriages
- For use on gantry cranes and lifting equipment

## Dimensions

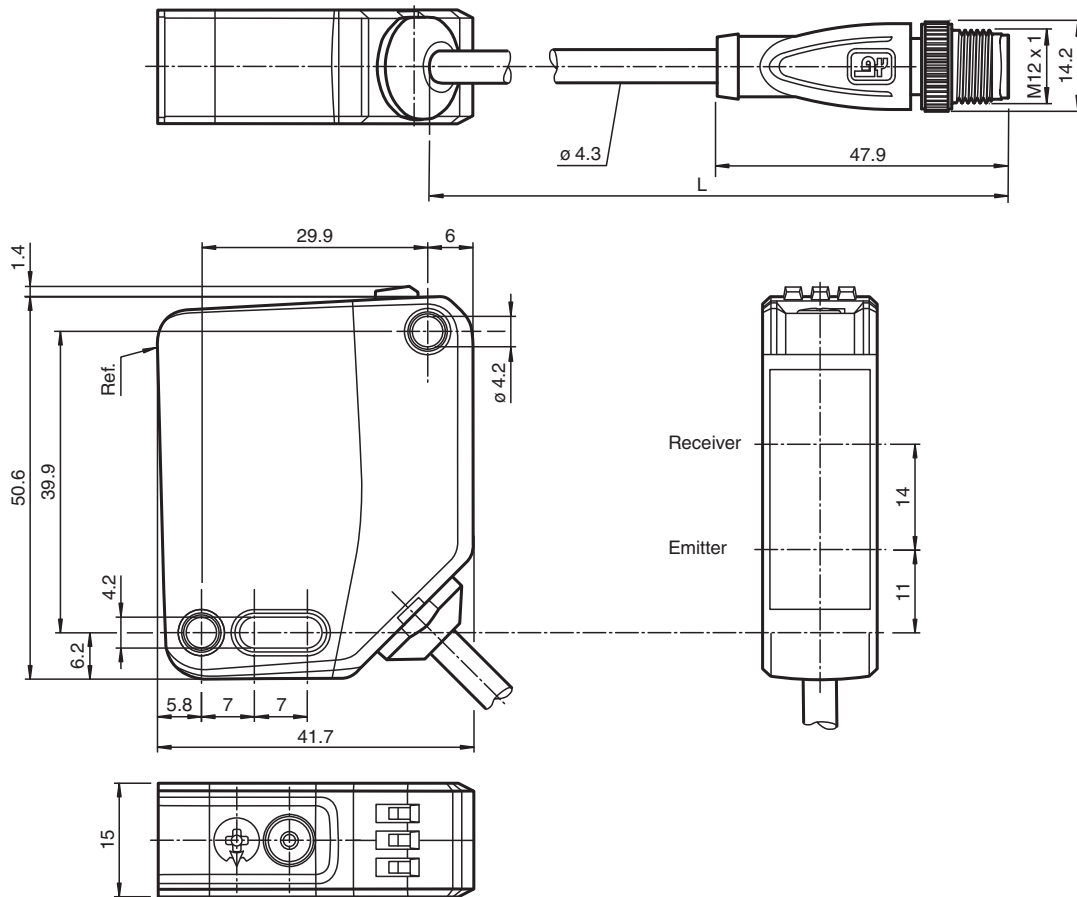

## Technical Data

General specifications	
Measuring range	0.03 ... 10 m
Reference target	standard white 90 %, 100 mm x 100 mm
Light source	laser diode
Light type	modulated visible red light
Laser nominal ratings	
Note	LASER LIGHT , DO NOT STARE INTO BEAM
Laser class	1
Wave length	660 nm
Beam divergence	2 mrad
Pulse length	4 ns
Repetition rate	300 kHz
max. pulse energy	< 1.3 nJ
Measuring method	Pulse Ranging Technology (PRT)
Max. Motion velocity	10 m/s
Diameter of the light spot	< 20 mm at 10 m
Ambient light limit	50000 Lux @ 2.5m standard white 90 % 10000 Lux @ 2.5m black 6 %
Resolution	1 mm
Temperature influence	< 0.25 mm/K
Functional safety related parameters	
MTTF <sub>d</sub>	> 300 a
Mission Time (T <sub>M</sub> )	20 a
Diagnostic Coverage (DC)	0 %

## Technical Data

Indicators/operating means		
Operation indicator		LED green: constantly on - power on flashing (4Hz) - short circuit flashing with short break (1 Hz) - IO-Link mode
Function indicator		LED yellow: constantly on - switch output active constantly off - switch output inactive
Teach-in indicator		Teach-In : LED yellow/green; equiphase flashing; 2,5 Hz Teach Error:LED green/yellow non equiphase flashing; 8.0 Hz
Control elements		Teach-In key
Control elements		5-step rotary switch for operating modes selection
Electrical specifications		
Operating voltage	$U_B$	10 ... 30 V DC 18 ... 30 V from IO-Link
Ripple		10 % within the supply tolerance
No-load supply current	$I_0$	< 25 mA at 24 V Operating voltage
Protection class		III
Time delay before availability	$t_v$	< 900 ms
Interface		
Interface type		IO-Link ( via C/Q = pin 4 )
IO-Link revision		1.1
Device profile		Identification and Diagnosis - I&D Smart Sensor - SSP 4.2.1
Process data		Input 6 Byte - measurement value 4 Byte - scaling factor 8 Bit - signal quality 2 Bit - switching signal 1 1 Bit - switching signal 2 1 Bit - diagnosis signals n Bit - additional signals n Bit Output 2 Bit - sensor control function 1 Bit - evaluation freeze 1 Bit
Vendor ID		1 (0x0001)
Device ID		1121025 (0x111B01)
Transfer rate		COM2 (38.4 kBit/s)
Min. cycle time		4 ms
SIO mode support		yes
Output		
Switching type		The default setting is: C/Q - Pin4: push-pull output, IO-Link Q2 - Pin2: push-pull output
Signal output		2x push-pull outputs, reverse polarity protected, surge-proof
Switching voltage		max. 30 V DC
Switching current		max. 100 mA , resistive load
Usage category		DC-12 and DC-13
Voltage drop	$U_d$	≤ 1.5 V DC
Conformity		
Communication interface		IEC 61131-9 / IO-Link V1.1.3
Laser safety		EN 60825-1:2014
Measurement accuracy		
Warm up time		5 min
Measured value output		1 ms
Average data age		3 ms (default), 6 ms , 12 ms , 25 ms , 50 ms , 100 ms , adjustable
Absolute accuracy		typ. ± 20 mm (including influence of temperature)
Repeat accuracy		< 3 mm
Approvals and certificates		
UL approval		E87056 , cULus Listed , class 2 power supply , type rating 1
CCC approval		CCC approval / marking not required for products rated ≤36 V

Release date: 2025-02-10 Date of issue: 2025-02-10 Filename: 295670-100400\_eng.pdf

## Technical Data

FDA approval	IEC 60825-1:2014 Complies with 21 CFR 1040.10 and 1040.11 except for conformance with IEC 60825-1 Ed. 3 as described in Laser Notice 56, dated May 8, 2019.
<b>Ambient conditions</b>	
Ambient temperature	-30 ... 60 °C (-22 ... 140 °F)
Storage temperature	-40 ... 70 °C (-40 ... 158 °F)
<b>Mechanical specifications</b>	
Degree of protection	IP67 / IP69 / IP69K
Connection	300 mm fixed cable with M12 x 1, 4-pin connector
<b>Material</b>	
Housing	PC (Polycarbonate)
Optical face	PMMA
Mass	approx. 37 g
<b>Dimensions</b>	
Height	50.6 mm
Width	15 mm
Depth	41.7 mm
<b>Factory settings</b>	
Switching output 1	Q1: switching signal high-active , Window mode 6000 ... 9000 mm
Switching output 2	Q2: switching signal high-active , Window mode 4000 ... 8000 mm

## Connection Assignment

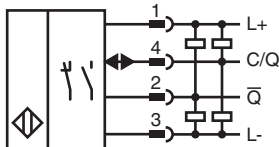

## Connection Assignment

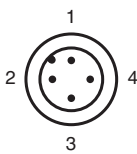

Wire colors in accordance with EN 60947-5-2

1	BN	(brown)
2	WH	(white)
3	BU	(blue)
4	BK	(black)

**Assembly**

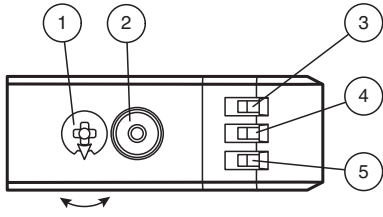

1	Mode rotary switch	
2	Teach-in button	
3	Switching output display Q2	YE
4	Switching output display Q1	YE
5	Operating indicator	GN

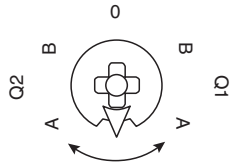

Q1B	Switching output 1/switch point B
Q1A	Switching output 1/switch point A
Q2A	Switching output 2/switch point A
Q2B	Switching output 2/switch point B
0	Keylock

**Characteristic Curve**

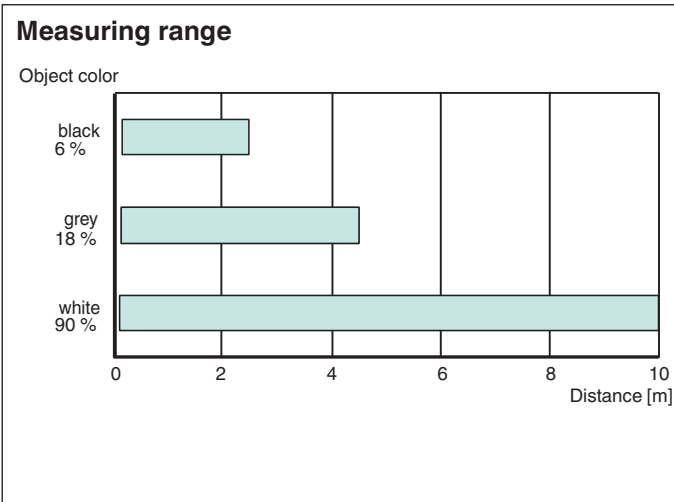

**Safety Information**

**Laser Class 1 Information**

The irradiation can lead to irritation especially in a dark environment. Do not point at people!

Maintenance and repairs should only be carried out by authorized service personnel!

Attach the device so that the warning is clearly visible and readable.

Caution – Use of controls or adjustments or performance of procedures other than those specified herein may result in hazardous radiation exposure.

Release date: 2025-02-10 Date of issue: 2025-02-10 Filename: 295670-100400\_eng.pdf

## Commissioning

### Teach-In (TI)

Use the rotary switch for switching signal **Q1** or **Q2** to select the relevant switching threshold A and/or B to teach in.

- The yellow LEDs indicate the current state of the selected output.

To teach in a switching threshold, press and hold the "TI" button for approximately 1 s, until the yellow and green LEDs flash in phase. Teach-in starts when the "TI" button is released.

- Teach-in successful: the yellow and green LEDs flash alternately at 2.5 Hz.
- Teach-in unsuccessful: the yellow and green LEDs quickly flash alternately at 8 Hz.

After an unsuccessful Teach-in, the sensor continues to operate with the previous valid setting after the relevant visual fault signal is issued.

Set switching mode: you can define different switching modes by teaching in the relevant distance data for switching thresholds A and B.

#### 1. Single point mode:

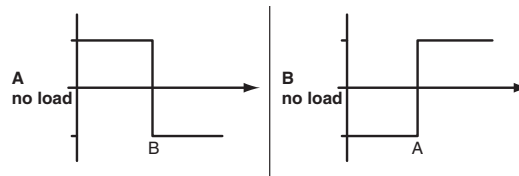

#### 2. Window mode:

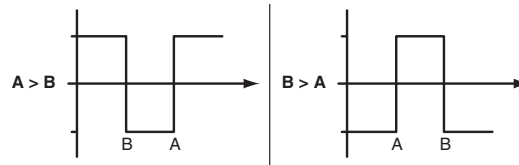

Teach in switching thresholds: you can teach in or overwrite a taught-in switching threshold at any time. To do this, press the "TI" button again.

Reset a value: you can reset a taught-in value. To do this, press the "TI" button for > 4 s, until the yellow and green LEDs go out. The reset process itself starts when the "TI" button is released.

- Reset successful: the yellow and green LEDs flash alternately at 2.5 Hz.

### Resetting to Factory Settings

To revert back to factory settings, press the "TI" button for > 10 s with the rotary switch set to position "O," until the yellow and green LEDs go out at the same time. The reset process itself starts when the "TI" button is released.

- Reset to factory settings successful: the yellow and green LEDs light up at the same time. The sensor then continues to operate with factory settings.

## Configuration

### Setting different operating modes via the IO-Link interface

The devices are equipped with an IO-Link interface as standard for diagnostics and parameterization tasks to ensure optimum adjustment of the sensors to the relevant application.

#### Single point mode operating mode (one switch point):

- "Detection of objects irrespective of type and color in a defined detection range. Objects in the background are suppressed.
- "The switch point corresponds exactly to the set point.



#### Window mode operating mode (two switch points):

- Detection of objects irrespective of type and color in a defined detection range. Reliable detection when object leaves the detection range.
- Window mode with two switch points.



**Center window mode operating mode (one switch point):**

- Detection of objects irrespective of type and color in a defined detection range. Sets a defined window around a given object. Objects outside this window are not detected.
- Window mode with one switch point.

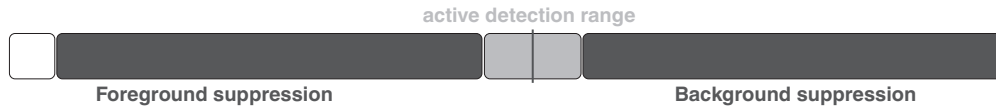

**Two point mode operating mode (hysteresis operating mode):**

- Detection of objects irrespective of type and color between a defined switch-on and switch-off point.

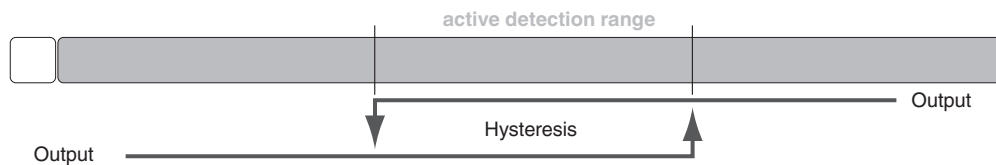

**Inactive operating mode:**

- Evaluation of switching signals is deactivated.

The associated IODD device description file can be found in the download area at [www.pepperl-fuchs.com](http://www.pepperl-fuchs.com).