

# Inductive sensor

## NBB15-U1-A2-T

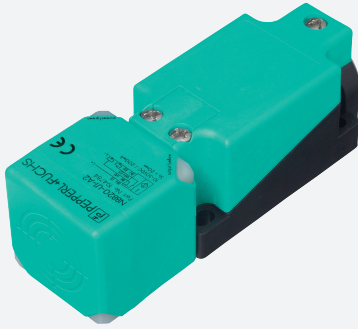

- Sensor head bidirectional and rotatable
- 15 mm flush
- 4 LEDs indicator for 360° visibility
- Temperature range  
-25 ... 100 °C (-13 ... 212 °F)



### Dimensions

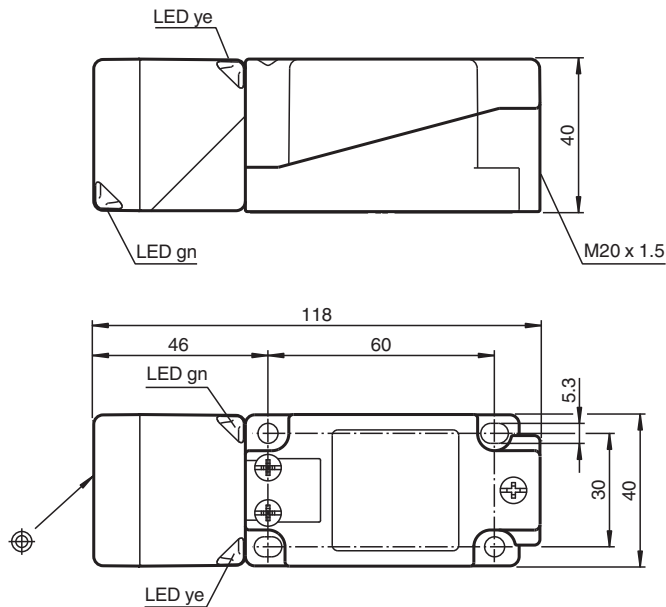

### Technical Data

#### General specifications

Rated operating distance	$s_n$	15 mm
Installation		flush
Output polarity		DC
Assured operating distance	$s_a$	0 ... 12.15 mm
Reduction factor $r_{Al}$		0.33
Reduction factor $r_{Cu}$		0.3
Reduction factor $r_{304}$		0.74
Reduction factor $r_{Brass}$		0.41
Output type		4-wire

#### Nominal ratings

Operating voltage	$U_B$	10 ... 30 V
Switching frequency	$f$	0 ... 560 Hz

## Technical Data

Hysteresis	H	typ. 5 %
Reverse polarity protection		reverse polarity protected
Short-circuit protection		pulsing
Voltage drop	$U_d$	$\leq 2$ V
Operating current	$I_L$	0 ... 200 mA
Off-state current	$I_r$	0 ... 0.5 mA
No-load supply current	$I_0$	$\leq 20$ mA
Time delay before availability	$t_v$	80 ms
Operating voltage indicator		LED, green
Switching state indicator		LED, yellow
<b>Functional safety related parameters</b>		
MTTF <sub>d</sub>		1230 a
Mission Time (T <sub>M</sub> )		20 a
Diagnostic Coverage (DC)		0 %
<b>Compliance with standards and directives</b>		
Standard conformity		
Standards		EN IEC 60947-5-2
<b>Approvals and certificates</b>		
UL approval		cULus Listed, General Purpose
CCC approval		CCC approval / marking not required for products rated $\leq 36$ V
<b>Ambient conditions</b>		
Ambient temperature		-25 ... 100 °C (-13 ... 212 °F)
<b>Mechanical specifications</b>		
Connection type		screw terminals
Core cross section		max. 2.5 mm <sup>2</sup>
Housing material		PA/metal with epoxy powder coating
Sensing face		PA
Housing base		plastic
Degree of protection		IP68 / IP69K
Mass		225 g
Dimensions		
Height		40 mm
Width		40 mm
Length		118 mm
Note		Tightening torque: 1.8 Nm (housing) Tightening torque: 1.0 Nm (Screw terminal)

## Connection

