

Control Unit Ex e, Panel Mount, Emergency Stop

PMP.E5.C.02

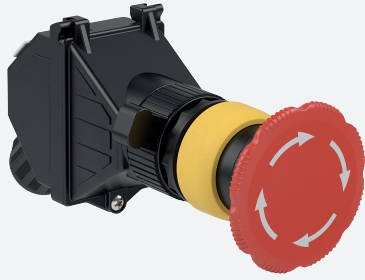

- Emergency stop mushroom button 55 mm, red, twist-to-release - 2x NC
- Ex de and Ex tb certified
- Full equipment certified
- Polyamide housing for panel mount
- Installation in Zone 1, Zone 2, Zone 21 and Zone 22
- Cable Gland M20 integrated in protective cover
- Degree of protection IP66



Connection

	11	23
0	X	X
I		
	12	24

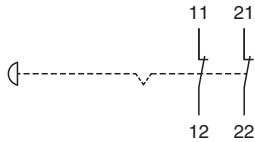

Dimensions

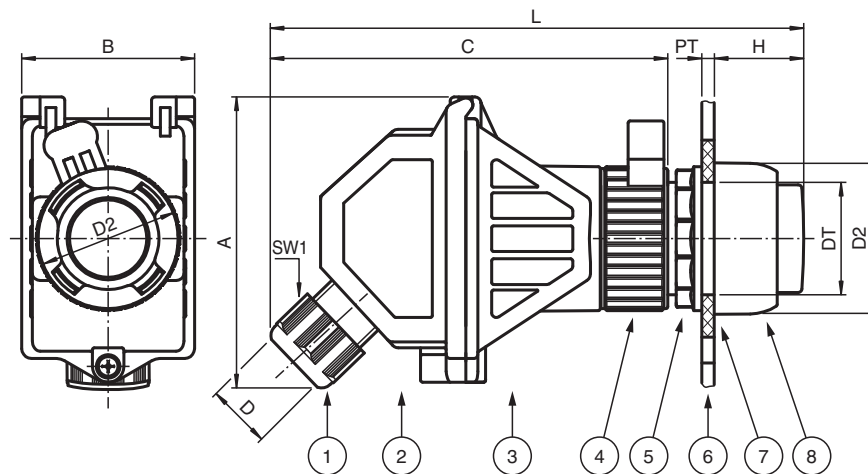

Release date: 2023-04-17 Date of issue: 2023-04-17 Filename: 297345_eng.pdf

Dimensions

Details see data table

Legend	
1	Cable gland
2	Protective cover
3	Contact module
4	Bayonet catch
5	Locknut
6	Panel / enclosure wall
7	Flat gasket
8	Actuator head
A	Height
B	Width
C	Depth
D	Clamping range, cable sheath diameter
DT	Diameter thru-hole
D2	Outer diameter actuator head
H	Length outside enclosure
L	Total length
PT	Panel / enclosure wall thickness

Technical Data

Electrical specifications

Operating voltage	250 V max.
Operating current	16 A max.
Terminal capacity	2x 2.5 mm ²
Terminal torque	0.8 Nm
Function	mushroom button 55 mm
Color	red
Contact configuration	2x NC all NC contacts have a direct opening action for emergency stop functions
Usage category	AC12 - 12 ... 250 V AC - 16 A AC15 - 12 ... 250 V AC - 10 A DC13 - 12 ... 110 V DC - 1 A DC13 - 12 ... 24 V DC - 1A
Number of poles	2
Operator action	latching , twist to release

Mechanical specifications

Cable type	non-armored cables
Clamping range (D)	5.5 ... 13 mm (D)
Covering	Protective cover fully detachable
Cover fixing	Phillips head screw
Degree of protection	IP66
Cable entry	
Number of cable entries	1x M20 cable gland in protective cover
Material	
Housing	Polyamide (PA)
Finish	inherent color black
Seal	silicone
Washer gasket	silicone
Mass	150 g max.

Release date: 2023-04-17 Date of issue: 2023-04-17 Filename: 297345_eng.pdf

Technical Data

Dimensions		
Height (A)		77 mm (A)
Width (B)		44 mm (B)
Depth (C)		105 mm (C)
Actuator head diameter (D2)		55 mm (D2)
Panel wall thickness (PT)		1 ... 6 mm (PT)
Diameter thru-hole (DT)		30.6 mm (DT)
Length outside enclosure (H)		41.8 mm (H)
Width across flats (SW1)		24 mm (SW1)
Total length (L)		153.7 mm (L)
Tightening torque		
Nut torque at enclosure (SW1)		2 Nm (SW1)
Mounting		via actuator head
Ambient conditions		
Ambient temperature		-40 ... 50 °C (-40 ... 122 °F)
Data for application in connection with hazardous areas		
EU-type examination certificate		CML 16 ATEX 3106X
Marking		Ⓜ II 2 GD Ex de IIC T6 Gb Ex tb IIIC T80 °C Db
International approvals		
IECEX approval		IECEX CML 16.0046X
UKCA approval		CML 21 UKEX 21275X
Conformity		
Degree of protection		EN 60529
Usage category		IEC / EN 60947
CE marking		0080 or 0102, see type label
General information		
Supplementary information		EC-Type Examination Certificate, Statement of Conformity, Declaration of Conformity, Attestation of Conformity and instructions have to be observed where applicable. For information see www.pepperl-fuchs.com .