

# Active infrared scanner

## DoorScan-DS-2P-1200

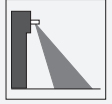

- Moving presence sensor for automatic doors
- SIL 2, certified in accordance with DIN 18650/EN 16005
- Exceptional detection reliability
- Reliable operation with all floor coverings
- Complete protection up to the wall without sensor shutoff
- Additional protection of the main and secondary closing edges
- Tool-free module mounting using snap-in mechanism
- Switchable NPN or PNP outputs

Light curtain for individual protection for automatic doors in accordance with DIN 18650/EN 16005, complete system for a door measuring up to 1200 mm wide, NPN output



### Function

DoorScan is a presence sensor for automatic revolving doors. It uses active infrared technology to perform background evaluation. The sensor is suitable for mobile or stationary mounting. Because the emitter and receiver module can be repositioned freely, the field of view can also be adjusted to fit the door width. An interface controls both sides of the door and establishes the link to the door controller. DoorScan meets the requirements of DIN 18650 and is a safety system fulfilling PL d in accordance with DIN EN ISO 13849-1 used in conjunction with a secure door controller that generates and evaluates the test signals.

### Application

- Protection mechanism for closing edges on automatic doors
- Anti-collision protection for people/objects in the vicinity of revolving or carousel doors

## Dimensions

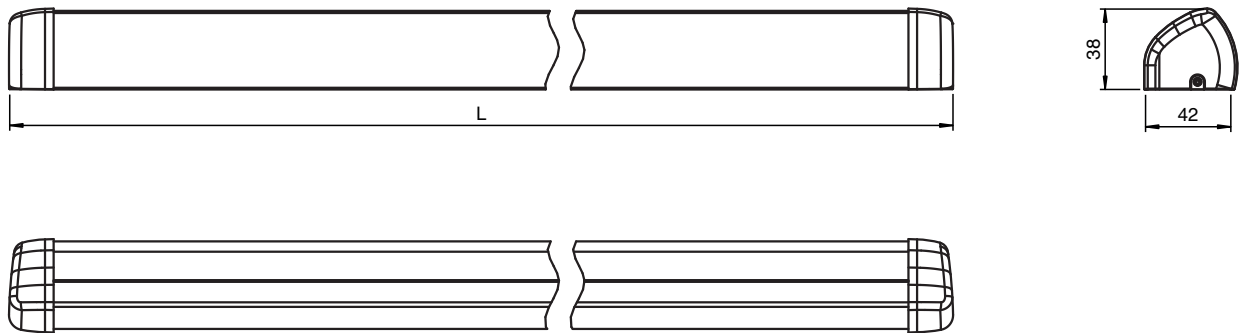

## Technical Data

### General specifications

Detection range min.	0 ... 1500 mm
Detection range max.	0 ... 3500 mm (Upright CA test body)
Sensing range	1000 mm at installation height of 2100 mm
Light source	IRED 850 nm
Black-white difference (6 %/90 %)	< 2 % at 2000 mm sensor range
Number of beams	10
Operating mode	Background evaluation
Diameter of the light spot	8 cm at 2000 mm sensor range

### Functional safety related parameters

Safety Integrity Level (SIL)	SIL 2
Performance level (PL)	PL d
Category	Cat. 2
MTTF <sub>d</sub>	112.7 a
Mission Time (T <sub>M</sub> )	10 a

### Indicators/operating means

Function indicator	Receiver: Red LED: detection, excess gain, fault code Interface: Red LED: detection, excess gain, fault code Yellow LED: teach status Green LED: blank status Green LED: DIP switch status
Control elements	Teach-In key , DIP switch for selection of operating modes

### Electrical specifications

Operating voltage	U <sub>B</sub>	24 V DC +/- 20 %
-------------------	----------------	------------------

## Technical Data

No-load supply current	$I_0$	max. 200 mA
Power consumption	$P_0$	4.8 W
<b>Input</b>		
Test input		high level $\geq 15$ V low level $\leq 2$ V
Control input		Standby active at $U = 11$ V DC at 30 V DC
<b>Output</b>		
Switching type		light-on
Signal output		switchable NPN or PNP , short-circuit protected
Switching voltage		max. 30 V DC
Switching current		max. 100 mA
Response time		$\leq 52$ ms $\leq 200$ ms in boost operating mode
<b>Conformity</b>		
Functional safety		ISO 13849-1 ; EN 61508 part1-4
Product standard		EN 12978
<b>Approvals and certificates</b>		
CCC approval		CCC approval / marking not required for products rated $\leq 36$ V
<b>Ambient conditions</b>		
Ambient temperature		$-30 \dots 60$ °C ( $-22 \dots 140$ °F)
<b>Mechanical specifications</b>		
Housing length L		1200 mm
Mounting height		max. 3500 mm
Degree of protection		IP54 (when mounted)
Connection		Plug-in terminal with 6-wire connection cable
<b>Material</b>		
Housing		Aluminum / PA
Optical face		PC (Polycarbonate)
Mass		approx. 2100 g
Dimensions		(W x H x D) : 42 mm x 1200 mm x 37 mm
<b>General information</b>		
Scope of delivery		Sensor system for hinge side and leading edge side (2 emitter and receiver modules each, 1 interface module, connecting cable, 2 housing profiles and optical covers each, 4 end caps)

## Connection Assignment

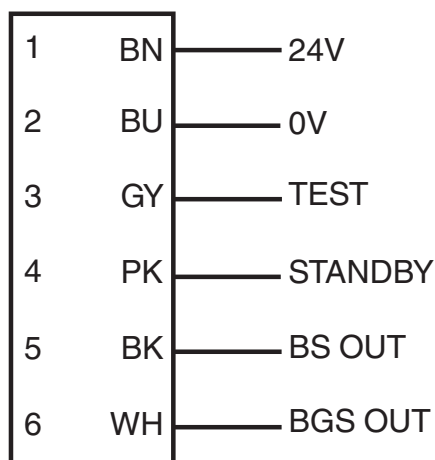





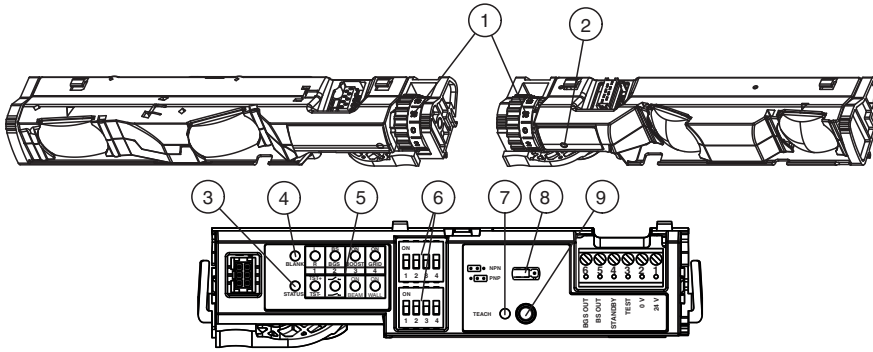





Release date: 2022-07-15 Date of issue: 2022-07-15 Filename: 299664\_eng.pdf

## Assembly



- |   |                             |
|---|-----------------------------|
| 1 Adjusting wheel for inclination angle | 6 DIP switch - rows 1 and 2 |
| 2 Receiver indicator LED, red           | 7 Teach LED, yellow         |
| 3 Status LED, red                       | 8 Jumper                    |
| 4 Blank LED, green                      | 9 Teach button              |
| 5 DIP LEDs, green                       |                             |

## Accessories

	<b>DoorScan Weather Cap L1200</b>	All-weather hood for DoorScan® and TopScan series sensing strips
	<b>DoorScan Transfer Loop</b>	Door transition cable to door controller for DoorScan® sensor, including cable sheathing and strain relief
	<b>DoorScan Connection Cable 5p</b>	Connecting cable with 5 plug-in connections for DoorScan®-I/-T/-R modules
	<b>DoorScan Cable BS/BGS</b>	Connecting cable for transition from hinge side to leading edge side
	<b>DoorScan End Caps</b>	End cap set for DoorScan® sensor profile
	<b>TopScan-S Profile L1400</b>	Housing profile TopScan-S
	<b>TopScan-S Cover L1400</b>	Housing cover TopScan-S
	<b>DoorScan Relay Module</b>	Replacement/extension sensor module for installation in the DoorScan® and TopScan sensor profile, multifunction interface module
	<b>DoorScan Adapter</b>	Adapter module for installation in the DoorScan® and TopScan sensor profile, multifunction interface module
	<b>DoorScan Cable Adapter</b>	Adapter module for installation in the DoorScan® sensor profile, multifunction interface module

**Additional Information**

**Layout of the sensor system for a door (door hinge side/hinge opposite side)**

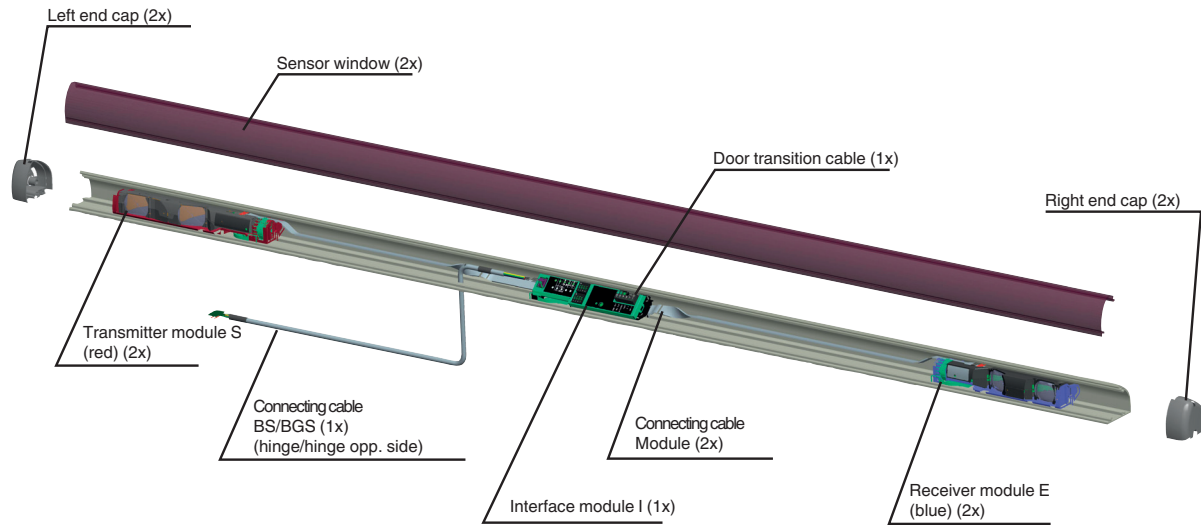

**Standby**

When the supply voltage is applied, the sensor is put into standby; the energy consumption is reduced to less than 80 % in this state. Once the signal is deactivated, the sensor is immediately ready for operation and enables the signal outputs within 52 ms and/or 200 ms (in boost operating mode) if the detection field is free.

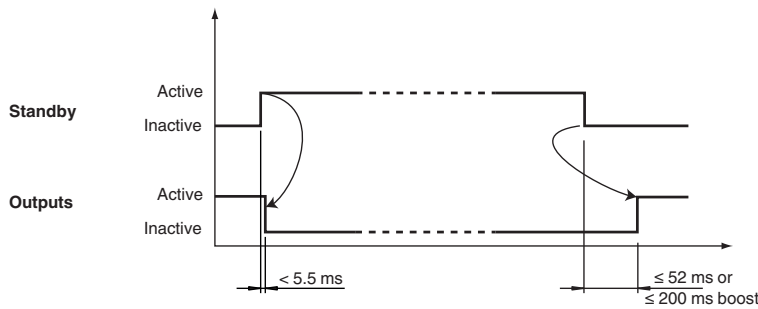

**Test input circuit**

DoorScan test input circuit

Test Function	Test inactive	Test active	Interface, bottom row, Dip switch 1 and 2
High active			
Low active			
High inactive			
Low inactive			

**Test signal**

The signal outputs enable crossed circuit detection. To do so, the outputs carry out a delayed shutoff from each other (see signal curve).

Release date: 2022-07-15 Date of issue: 2022-07-15 Filename: 299664\_eng.pdf

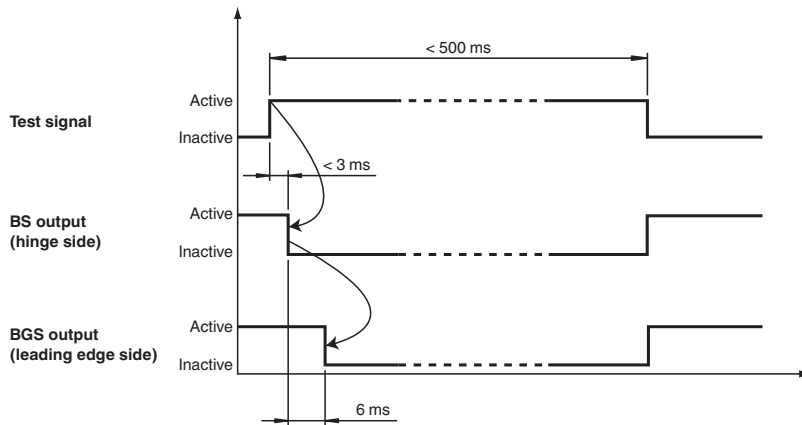
**Note!**

The test signal must be in contact with the test input for at least 9 ms!  
The duration of the test signal must not exceed 0.5 s, otherwise this will deactivate the sensor.

**Operating modes****Boost operating mode**

Activation with dark floors, even at high installation heights (increased sensitivity). In these cases, the response time of the sensor is increased from 50 ms to 200 ms. If necessary, the speed of the door must be adjusted to the response time.

**Grid operating mode**

Activation in the event of faults due to metal grating on the ground. Used where metal grating and shafts are present in the detection field.

**BEAM**

Off: outer beams normal

On: outer beams at an angle (factory setting)

You can switch off the beams extending beyond the emitter modules manually to avoid detection of deep door jambs.

**WALL**

Off: automatic wall suppression not active

On: automatic wall suppression active (factory setting)

If the door panel does not open against a wall, you can switch off wall suppression to accelerate the commissioning process.

Metal grating mode is improved if receiver modules are used from device version V.03 onward.

## Function Principle

DoorScan is an active infrared triangulation sensor with background analysis.

The ground is taught in as a reference and the sensor can learn flat walls on the hinge side and door posts on the leading edge side when the door is opened. This means that person detection can be ensured throughout the entire movement of the door.

**Characteristics**

The DoorScan housing comprises an aluminum profile system with a plastic cover, which can be adapted to a door width of up to 1200 mm. A minimum of one and a maximum of three emitter and receiver modules must be fitted on each side of the door. The interface must be installed on one side.

The modules should be arranged approx. 10 cm away from the edge of the door. If more than one emitter/receiver module is installed on each side, the modules must be overlapped (S1, S2, E1, E2).