

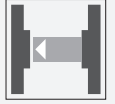

Thru-beam sensor (pair)

OBE40M-R200-S2EP-IO-0,3M-V1-L



- Medium design with versatile mounting options
- DuraBeam Laser Sensors - durable and employable like an LED
- IO-Link interface for service and process data
- Various frequencies for avoiding mutual interference (cross-talk immunity)
- Extended temperature range
-40 °C ... 60 °C
- High degree of protection IP69K

Laser thru-beam sensor



IO-Link

Function

The optical sensors in the series are the first devices to offer an end-to-end solution in a medium-sized standard design – from the thru-beam sensor through to the measuring distance sensor. As a result of this design, the sensors are able to perform practically all standard automation tasks.

The entire series enables sensors to communicate via IO-Link.

The DuraBeam laser sensors are durable and can be used in the same way as a standard sensor.

Multi Pixel Technology (MPT) ensures that the standard sensors are flexible and can be adapted to the application environment.

Dimensions

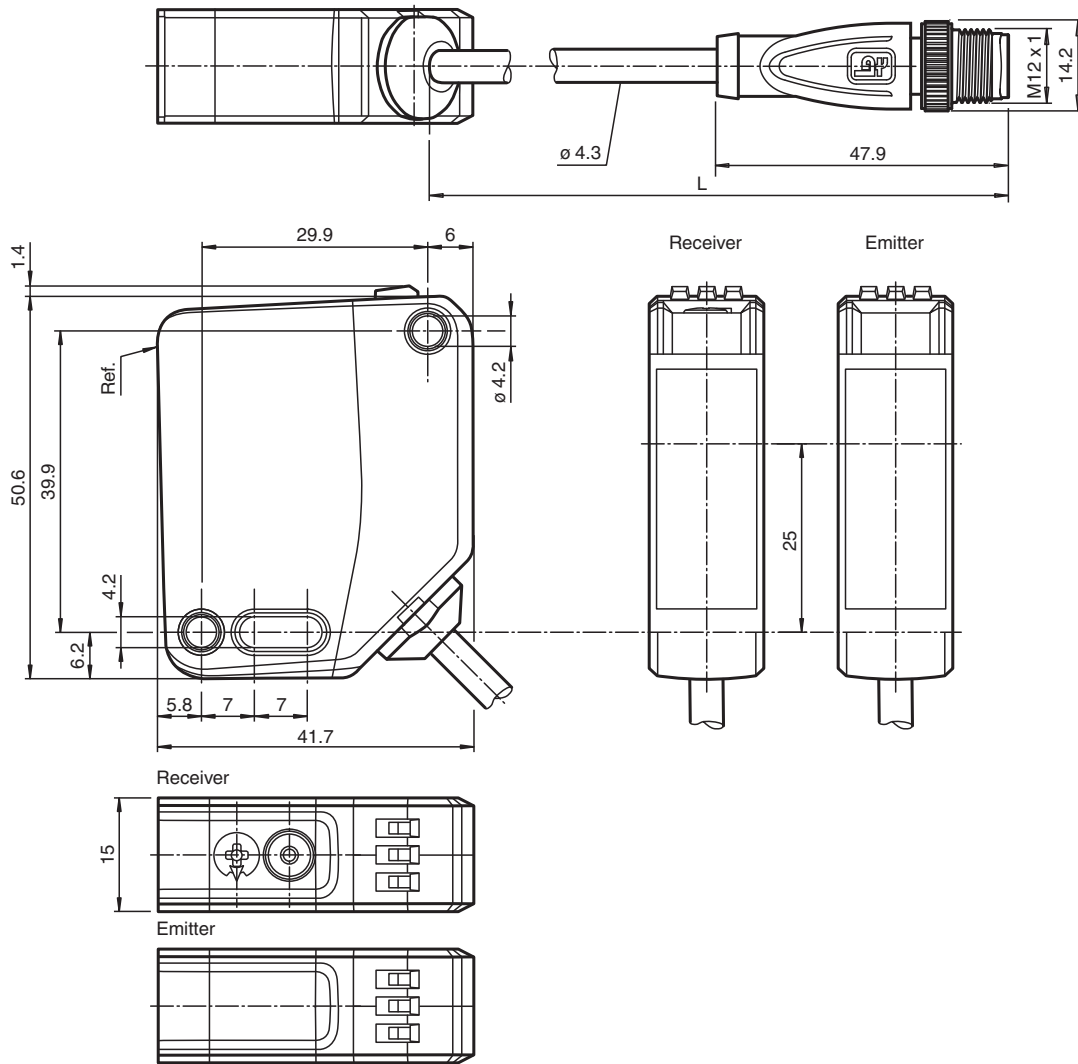

Technical Data

System components	
Emitter	OBE40M-R200-S-IO-0,3M-V1-L
Receiver	OBE40M-R200-2EP-IO-0,3M-V1-L
General specifications	
Effective detection range	0 ... 40 m
Threshold detection range	50 m
Light source	laser diode
Light type	modulated visible red light
Laser nominal ratings	
Note	LASER LIGHT , DO NOT STARE INTO BEAM
Laser class	1
Wave length	680 nm
Beam divergence	> 5 mrad ; d63 < 2 mm in the range of 250 mm ... 750 mm
Pulse length	1.6 μs
Repetition rate	max. 17.6 kHz
max. pulse energy	9.6 nJ
Alignment aid	LED red (in receiver lens) illuminated constantly: beam is interrupted, flashes: reaching switching point, off: sufficient operating reserve
Diameter of the light spot	approx. 80 mm at a distance of 40 m

Release date: 2025-01-17 Date of issue: 2025-01-17 Filename: 301065_eng.pdf

Technical Data

Opening angle		approx. 0.12 °
Ambient light limit		EN 60947-5-2 : 40000 Lux
Functional safety related parameters		
MTTF _d		440 a
Mission Time (T _M)		20 a
Diagnostic Coverage (DC)		60 %
Indicators/operating means		
Operation indicator		LED green: constantly on - power on flashing (4Hz) - short circuit flashing with short break (1 Hz) - IO-Link mode
Function indicator		Yellow LED: Permanently lit - light path clear Permanently off - object detected Flashing (4 Hz) - insufficient operating reserve
Control elements		Receiver: light/dark switch
Control elements		Receiver: sensitivity adjustment
Electrical specifications		
Operating voltage	U _B	10 ... 30 V DC
Ripple		max. 10 %
No-load supply current	I ₀	Emitter: ≤ 13 mA Receiver: ≤ 15 mA at 24 V Operating voltage
Protection class		III
Interface		
Interface type		IO-Link (via C/Q = pin 4)
IO-Link revision		1.1
Device profile		Identification and diagnosis Smart Sensor: Receiver: type 2.4 Emitter: -
Device ID		Emitter: 0x111402 (1119234) Receiver: 0x111302 (1118978)
Transfer rate		COM2 (38.4 kBit/s)
Min. cycle time		2.3 ms
Process data width		Emitter: Process data input: 0 bit Process data output: 1 bit Receiver: Process data input: 2 bit Process data output: 2 bit
SIO mode support		yes
Compatible master port type		A
Input		
Test input		emitter deactivation at +U _B
Output		
Switching type		The switching type of the sensor is adjustable. The default setting is: C/Q - Pin4: NPN normally open / dark-on, PNP normally closed / light-on, IO-Link /Q - Pin2: NPN normally closed / light-on, PNP normally open / dark-on
Signal output		2 push-pull (4 in 1) outputs, short-circuit protected, reverse polarity protected, overvoltage protected
Switching voltage		max. 30 V DC
Switching current		max. 100 mA , resistive load
Usage category		DC-12 and DC-13
Voltage drop	U _d	≤ 1.5 V DC
Switching frequency	f	1250 Hz
Response time		0.4 ms
Conformity		
Communication interface		IEC 61131-9
Product standard		EN 60947-5-2
Laser safety		EN 60825-1:2014

Technical Data

Approvals and certificates

UL approval	E87056 , cULus Listed , class 2 power supply , type rating 1
CCC approval	CCC approval / marking not required for products rated ≤36 V
FDA approval	IEC 60825-1:2014 Complies with 21 CFR 1040.10 and 1040.11 except for conformance with IEC 60825-1 Ed. 3 as described in Laser Notice 56, dated May 8, 2019.

Ambient conditions

Ambient temperature	-40 ... 60 °C (-40 ... 140 °F) , cable, fixed installation -20 ... 60 °C (-4 ... 140 °F) , movable cable not appropriate for conveyor chains
Storage temperature	-40 ... 70 °C (-40 ... 158 °F)

Mechanical specifications

Degree of protection	IP67 / IP69 / IP69K
Connection	300 mm fixed cable with M12 x 1, 4-pin connector
Material	
Housing	PC (Polycarbonate)
Optical face	PMMA
Mass	Emitter: approx. 45 g receiver: approx. 45 g
Dimensions	
Height	50.6 mm
Width	15 mm
Depth	41.7 mm
Cable length	0.3 m

Connection Assignment

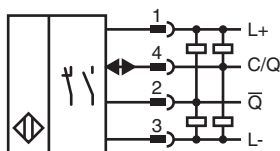
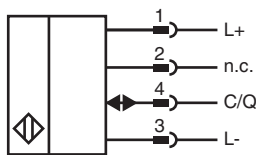

Connection Assignment

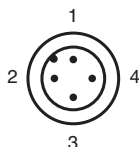

Connection Assignment

Wire colors in accordance with EN 60947-5-2

- | | | |
|---|----|---------|
| 1 | BN | (brown) |
| 2 | WH | (white) |
| 3 | BU | (blue) |
| 4 | BK | (black) |

Assembly

Emitter

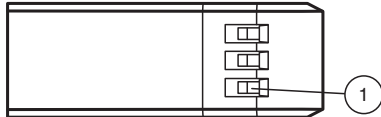

1	Operating indicator
---	---------------------

Receiver

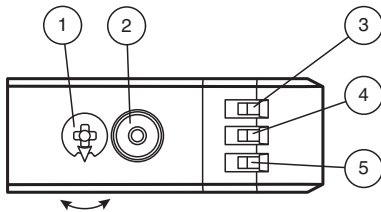

1	Sensitivity adjustment	
2	Light-on / dark-on changeover switch	
3	Operating indicator / dark on	GN
4	Signal indicator	YE
5	Operating indicator / light on	GN

Characteristic Curve

Characteristic response curve

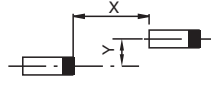
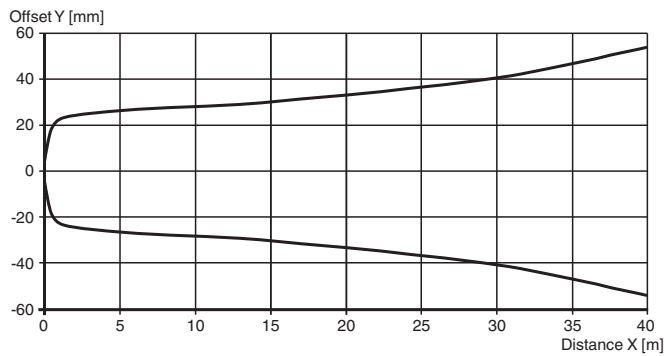

Release date: 2025-01-17 Date of issue: 2025-01-17 Filename: 301065_eng.pdf

Characteristic Curve

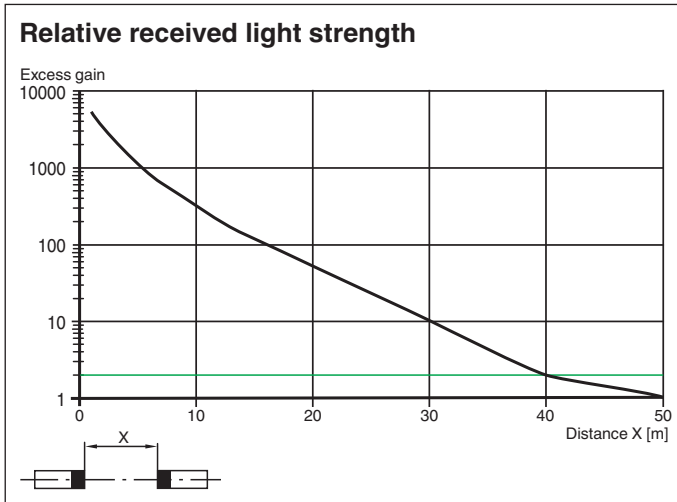

Safety Information

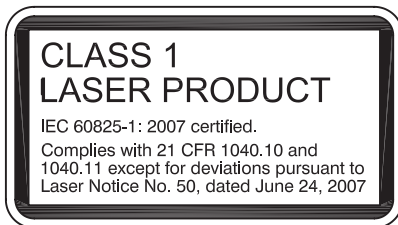

Commissioning

To unlock the adjustment functions turn the sensing range / sensitivity adjuster for more than 180 degrees.

Sensing Range / Sensitivity

Turn sensing range / sensitivity adjuster clockwise to increase sensing range / sensitivity.
 Turn sensing range / sensitivity adjuster counter clockwise to decrease sensing range / sensitivity.
 If the end of the adjustment range is reached, the signal indicator starts flashing with 8 Hz.

Light-on / Dark-on Configuration

Press the light-on / dark-on changeover switch for more than 1 second (less than 4 seconds). The light-on / dark-on mode changes and the operating indicators are activated accordingly.
 If you press the light-on / dark-on changeover switch for more than 4 seconds, the light-on / dark-on mode changes back to the original setting. On release of the light-on / dark-on changeover switch the current state is activated.

Restore Factory Settings

Press the light-on / dark-on changeover switch for more than 10 seconds (less than 30 seconds) until all LEDs turn off. On release of the light-on / dark-on changeover switch the signal indicator turns on. After 5 seconds the sensor resumes operation with factory default settings.

After 5 minutes of inactivity the sensing range / sensitivity adjustment is locked. In order to reactivate the sensing range / sensitivity adjustment, turn the sensing range / sensitivity adjuster for more than 180 degrees.