

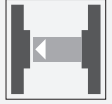

Thru-beam sensor (pair) OBE25M-R201-S2EP-IO-0,3M-V1



- Medium design with versatile mounting options
- IO-Link interface for service and process data
- Various frequencies for avoiding mutual interference (cross-talk immunity)
- Extended temperature range
-40 °C ... 60 °C
- High degree of protection IP69K



IO-Link

Function

The optical sensors in the series are the first devices to offer an end-to-end solution in a medium-sized standard design – from the thru-beam sensor through to the measuring distance sensor. As a result of this design, the sensors are able to perform practically all standard automation tasks.

The entire series enables sensors to communicate via IO-Link.

The DuraBeam laser sensors are durable and can be used in the same way as a standard sensor.

Multi Pixel Technology (MPT) ensures that the standard sensors are flexible and can be adapted to the application environment.

Dimensions

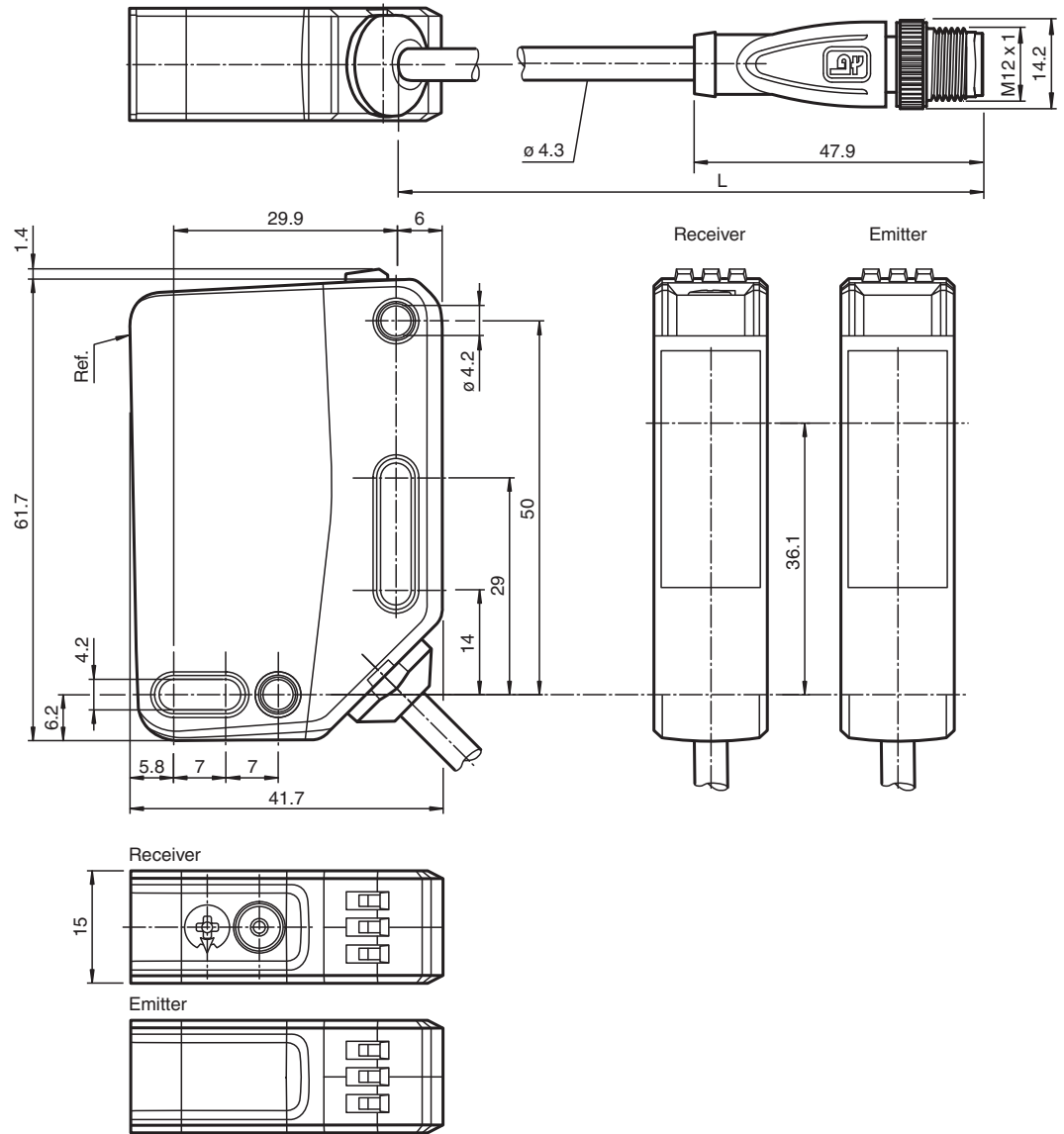

Technical Data

| | |
|---|---|
| System components | |
| Emitter | OBE25M-R201-S-IO-0,3M-V1 |
| Receiver | OBE25M-R201-2EP-IO-0,3M-V1 |
| General specifications | |
| Effective detection range | 0 ... 25 m |
| Threshold detection range | 33 m |
| Light source | LED |
| Light type | modulated visible red light |
| LED risk group labelling | exempt group |
| Alignment aid | LED red (in receiver lens) illuminated constantly: beam is interrupted, flashes: reaching switching point, off: sufficient stability control |
| Diameter of the light spot | approx. 850 mm at a distance of 25 m |
| Opening angle | approx. 2 ° |
| Ambient light limit | EN 60947-5-2 : 40000 Lux |
| Functional safety related parameters | |
| MTTF _d | 462 a |

Release date: 2023-01-16 Date of issue: 2023-01-16 Filename: 301109_eng.pdf

Technical Data

| | | |
|-----------------------------------|----------------|---|
| Mission Time (T _M) | | 20 a |
| Diagnostic Coverage (DC) | | 60 % |
| Indicators/operating means | | |
| Operation indicator | | LED green: constantly on - power on flashing (4Hz) - short circuit flashing with short break (1 Hz) - IO-Link mode |
| Function indicator | | Yellow LED: Permanently lit - light path clear Permanently off - object detected Flashing (4 Hz) - insufficient operating reserve |
| Control elements | | Receiver: light/dark switch |
| Control elements | | Receiver: sensitivity adjustment |
| Electrical specifications | | |
| Operating voltage | U _B | 10 ... 30 V DC |
| Ripple | | max. 10 % |
| No-load supply current | I ₀ | Emitter: ≤ 15 mA Receiver: ≤ 15 mA at 24 V Operating voltage |
| Protection class | | III |
| Interface | | |
| Interface type | | IO-Link (via C/Q = pin 4) |
| IO-Link revision | | 1.1 |
| Device profile | | Identification and diagnosis Smart Sensor: Receiver: type 2.4 Emitter: - |
| Device ID | | Emitter: 0x111411 (1119249) Receiver: 0x111311 (1118993) |
| Transfer rate | | COM2 (38.4 kBit/s) |
| Min. cycle time | | 2.3 ms |
| Process data width | | Emitter: Process data input: 0 bit Process data output: 1 bit Receiver: Process data input: 2 bit Process data output: 2 bit |
| SIO mode support | | yes |
| Compatible master port type | | A |
| Input | | |
| Test input | | emitter deactivation at +U _B |
| Output | | |
| Switching type | | The switching type of the sensor is adjustable. The default setting is: C/Q - Pin4: NPN normally open / dark-on, PNP normally closed / light-on, IO-Link /Q - Pin2: NPN normally closed / light-on, PNP normally open / dark-on |
| Signal output | | 2 push-pull (4 in 1) outputs, short-circuit protected, reverse polarity protected, overvoltage protected |
| Switching voltage | | max. 30 V DC |
| Switching current | | max. 100 mA , resistive load |
| Usage category | | DC-12 and DC-13 |
| Voltage drop | U _d | ≤ 1.5 V DC |
| Switching frequency | f | 1000 Hz |
| Response time | | 0.5 ms |
| Conformity | | |
| Communication interface | | IEC 61131-9 |
| Product standard | | EN 60947-5-2 |
| Approvals and certificates | | |
| UL approval | | E87056 , cULus Listed , class 2 power supply , type rating 1 |
| CCC approval | | CCC approval / marking not required for products rated ≤36 V |
| Ambient conditions | | |
| Ambient temperature | | -40 ... 60 °C (-40 ... 140 °F) , fixed cable -20 ... 60 °C (-4 ... 140 °F) , movable cable not appropriate for conveyor chains |

Technical Data

| | |
|----------------------------------|--|
| Storage temperature | -40 ... 70 °C (-40 ... 158 °F) |
| Mechanical specifications | |
| Housing width | 15 mm |
| Housing height | 61.7 mm |
| Housing depth | 41.7 mm |
| Degree of protection | IP67 / IP69 / IP69K |
| Connection | 300 mm fixed cable with M12 x 1, 4-pin connector |
| Material | |
| Housing | PC (Polycarbonate) |
| Optical face | PMMA |
| Mass | Emitter: approx. 55 g receiver: approx. 55 g |
| Cable length | 0.3 m |

Connection

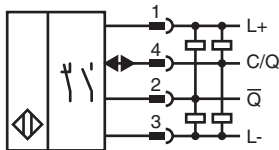
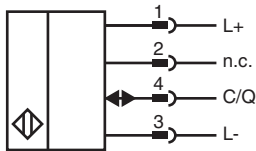

Connection Assignment

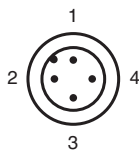

Wire colors in accordance with EN 60947-5-2

| | | |
|---|----|---------|
| 1 | BN | (brown) |
| 2 | WH | (white) |
| 3 | BU | (blue) |
| 4 | BK | (black) |

Assembly

Emitter

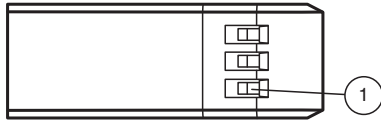

| | |
|---|---------------------|
| 1 | Operating indicator |
|---|---------------------|

Receiver

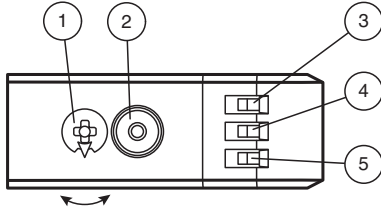

| | | |
|---|--------------------------------------|----|
| 1 | Sensitivity adjustment | |
| 2 | Light-on / dark-on changeover switch | |
| 3 | Operating indicator / dark on | GN |
| 4 | Signal indicator | YE |
| 5 | Operating indicator / light on | GN |

Characteristic Curve

Characteristic response curve

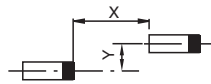
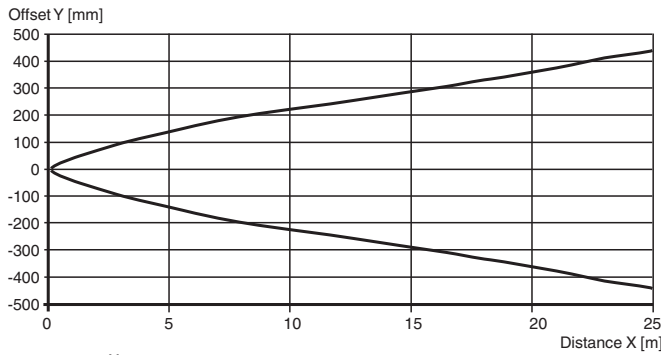

Relative received light strength

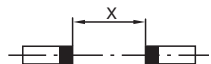
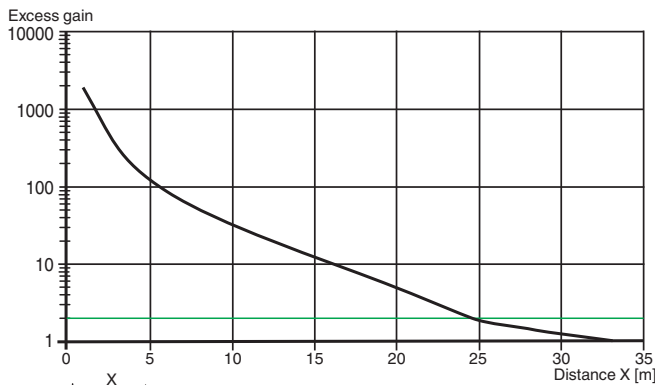

Commissioning

To unlock the adjustment functions turn the sensing range / sensitivity adjuster for more than 180 degrees.

Sensing Range / Sensitivity

Turn sensing range / sensitivity adjuster clockwise to increase sensing range / sensitivity.

Turn sensing range / sensitivity adjuster counter clockwise to decrease sensing range / sensitivity.

If the end of the adjustment range is reached, the signal indicator starts flashing with 8 Hz.

Light-on / Dark-on Configuration

Press the light-on / dark-on changeover switch for more than 1 second (less than 4 seconds). The light-on / dark-on mode changes and the operating indicators are activated accordingly.

Commissioning

















If you press the light-on / dark-on changeover switch for more than 4 seconds, the light-on / dark-on mode changes back to the original setting. On release of the light-on / dark-on changeover switch the current state is activated.

Restore Factory Settings

Press the light-on / dark-on changeover switch for more than 10 seconds (less than 30 seconds) until all LEDs turn off. On release of the light-on / dark-on changeover switch the signal indicator turns on. After 5 seconds the sensor resumes operation with factory default settings.

After 5 minutes of inactivity the sensing range / sensitivity adjustment is locked. In order to reactivate the sensing range / sensitivity adjustment, turn the sensing range / sensitivity adjuster for more than 180 degrees.

Accessories

| | | |
|---|-----------------------------|--|
|  | OMH-RL31-02 | Mounting bracket narrow |
|  | OMH-RL31-03 | Mounting bracket narrow |
|  | OMH-RL31-04 | Mounting aid for round steel \varnothing 12 mm or sheet 1.5 mm ... 3 mm |
|  | OMH-RL31-07 | Mounting bracket including adjustment |
|  | OMH-RL31-08 | Mounting aid for round steel \varnothing 12 mm or sheet 1.5 mm ... 3 mm |
|  | OMH-R20x-Quick-Mount | Quick mounting accessory |
|  | ICE2-8IOL-G65L-V1D | EtherNet/IP IO-Link master with 8 inputs/outputs |
|  | ICE3-8IOL-G65L-V1D | PROFINET IO IO-Link master with 8 inputs/outputs |
|  | ICE2-8IOL-K45S-RJ45 | EtherNet/IP IO-Link master with 8 inputs/outputs, DIN rail, screw terminal |
|  | ICE3-8IOL-K45P-RJ45 | PROFINET IO IO-Link master with 8 inputs/outputs, DIN rail, push-in terminals |
|  | ICE3-8IOL-K45S-RJ45 | PROFINET IO IO-Link master with 8 inputs/outputs, DIN rail, screw terminal |
|  | IO-Link-Master02-USB | IO-Link master, supply via USB port or separate power supply, LED indicators, M12 plug for sensor connection |
|  | ICE1-8IOL-G30L-V1D | Ethernet IO-Link module with 8 inputs/outputs |
|  | ICE1-8IOL-G60L-V1D | Ethernet IO-Link module with 8 inputs/outputs |
|  | ICE2-8IOL-K45P-RJ45 | EtherNet/IP IO-Link master with 8 inputs/outputs, DIN rail, push-in connectors |
|  | V1-G-2M-PUR | Female cordset single-ended M12 straight A-coded, 4-pin, PUR cable grey |
|  | V1-W-2M-PUR | Female cordset single-ended M12 angled A-coded, 4-pin, PUR cable grey |