



Thru-beam sensor (pair) OBE40M-R201-SEP-IO-V3-L



- Medium design with versatile mounting options
- DuraBeam Laser Sensors - durable and employable like an LED
- IO-Link interface for service and process data
- Various frequencies for avoiding mutual interference (cross-talk immunity)
- Extended temperature range
-40 °C ... 60 °C
- High degree of protection IP69K

Laser thru-beam sensor



IO-Link

Function

The optical sensors in the series are the first devices to offer an end-to-end solution in a medium-sized standard design – from the thru-beam sensor through to the measuring distance sensor. As a result of this design, the sensors are able to perform practically all standard automation tasks.

The entire series enables sensors to communicate via IO-Link.

The DuraBeam laser sensors are durable and can be used in the same way as a standard sensor.

Multi Pixel Technology (MPT) ensures that the standard sensors are flexible and can be adapted to the application environment.

Dimensions

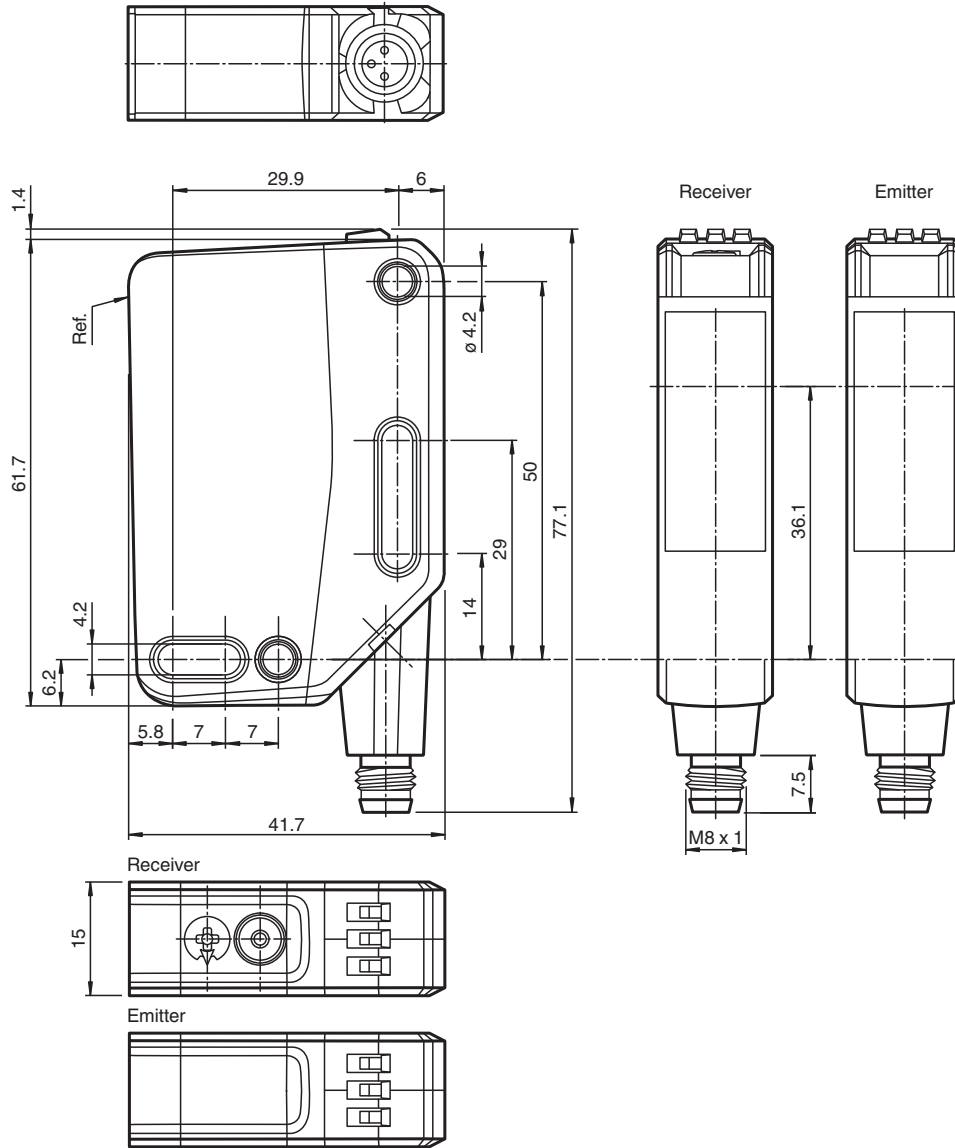

Technical Data

System components	
Emitter	OBE40M-R201-S-IO-V3-L
Receiver	OBE40M-R201-EP-IO-V3-L
General specifications	
Effective detection range	0 ... 40 m
Threshold detection range	50 m
Light source	laser diode
Light type	modulated visible red light
Laser nominal ratings	
Note	LASER LIGHT , DO NOT STARE INTO BEAM
Laser class	1
Wave length	680 nm
Beam divergence	> 5 mrad ; d63 < 2 mm in the range of 250 mm ... 750 mm
Pulse length	1.6 μs
Repetition rate	max. 17.6 kHz
max. pulse energy	9.6 nJ

Release date: 2025-01-17 Date of issue: 2025-01-17 Filename: 301128_eng.pdf

Technical Data

Alignment aid		LED red (in receiver lens) illuminated constantly: beam is interrupted, flashes: reaching switching point, off: sufficient operating reserve
Diameter of the light spot		approx. 80 mm at a distance of 40 m
Opening angle		approx. 0.12 °
Ambient light limit		EN 60947-5-2 : 40000 Lux
Functional safety related parameters		
MTTF _d		440 a
Mission Time (T _M)		20 a
Diagnostic Coverage (DC)		60 %
Indicators/operating means		
Operation indicator		LED green: constantly on - power on flashing (4Hz) - short circuit flashing with short break (1 Hz) - IO-Link mode
Function indicator		Yellow LED: Permanently lit - light path clear Permanently off - object detected Flashing (4 Hz) - insufficient operating reserve
Control elements		Receiver: light/dark switch
Control elements		Receiver: sensitivity adjustment
Electrical specifications		
Operating voltage	U _B	10 ... 30 V DC
Ripple		max. 10 %
No-load supply current	I ₀	Emitter: ≤ 13 mA Receiver: ≤ 15 mA at 24 V Operating voltage
Protection class		III
Interface		
Interface type		IO-Link (via C/Q = pin 4)
IO-Link revision		1.1
Device profile		Identification and diagnosis Smart Sensor: Receiver: type 2.4 Emitter: -
Device ID		Emitter: 0x111412 (1119250) Receiver: 0x111312 (1118994)
Transfer rate		COM2 (38.4 kBit/s)
Min. cycle time		2.3 ms
Process data width		Emitter: Process data input: 0 bit Process data output: 1 bit Receiver: Process data input: 2 bit Process data output: 2 bit
SIO mode support		yes
Compatible master port type		A
Input		
Test input		emitter deactivation at +U _B
Output		
Switching type		The switching type of the sensor is adjustable. The default setting is: C/Q - Pin4: NPN normally open / dark-on, PNP normally closed / light-on, IO-Link
Signal output		1 push-pull (4 in 1) output, short-circuit protected, reverse polarity protected, overvoltage protected
Switching voltage		max. 30 V DC
Switching current		max. 100 mA , resistive load
Usage category		DC-12 and DC-13
Voltage drop	U _d	≤ 1.5 V DC
Switching frequency	f	1250 Hz
Response time		0.4 ms
Conformity		

Technical Data

Communication interface	IEC 61131-9
Product standard	EN 60947-5-2
Laser safety	EN 60825-1:2014
Approvals and certificates	
UL approval	E87056 , cULus Listed , class 2 power supply , type rating 1
CCC approval	CCC approval / marking not required for products rated ≤36 V
FDA approval	IEC 60825-1:2014 Complies with 21 CFR 1040.10 and 1040.11 except for conformance with IEC 60825-1 Ed. 3 as described in Laser Notice 56, dated May 8, 2019.
Ambient conditions	
Ambient temperature	-40 ... 60 °C (-40 ... 140 °F)
Storage temperature	-40 ... 70 °C (-40 ... 158 °F)
Mechanical specifications	
Degree of protection	IP67 / IP69 / IP69K
Connection	Connector plug, M8 x 1, 3 pin, rotatable by 90°
Material	
Housing	PC (Polycarbonate)
Optical face	PMMA
Mass	Emitter: approx. 44 g receiver: approx. 44 g
Dimensions	
Height	61.7 mm
Width	15 mm
Depth	41.7 mm

Connection

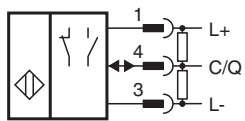
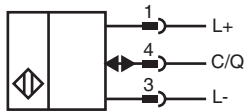

Connection Assignment



Connection Assignment

Wire colors in accordance with EN 60947-5-2

- | | | |
|---|----|---------|
| 1 | BN | (brown) |
| 3 | BU | (blue) |
| 4 | BK | (black) |

Assembly

Emitter

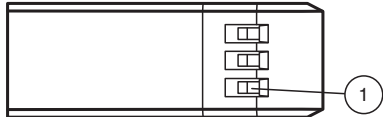

1	Operating indicator
---	---------------------

Receiver

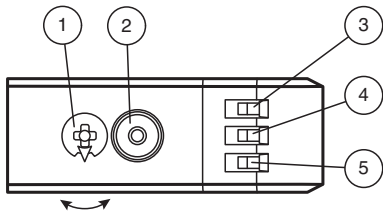

1	Sensitivity adjustment	
2	Light-on / dark-on changeover switch	
3	Operating indicator / dark on	GN
4	Signal indicator	YE
5	Operating indicator / light on	GN

Characteristic Curve

Characteristic response curve

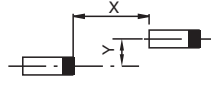
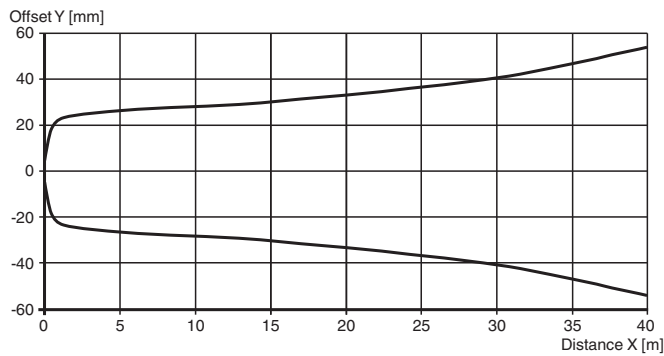

Release date: 2025-01-17 Date of issue: 2025-01-17 Filename: 301128_eng.pdf

Characteristic Curve

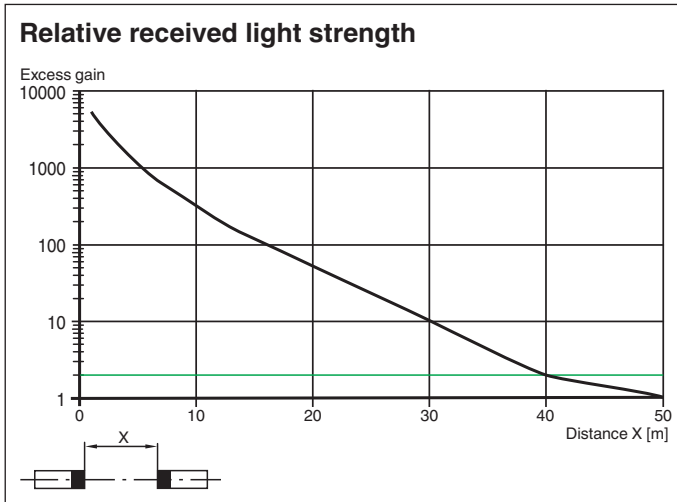

Safety Information

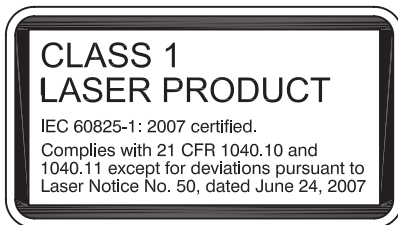

Commissioning

To unlock the adjustment functions turn the sensing range / sensitivity adjuster for more than 180 degrees.

Sensing Range / Sensitivity

Turn sensing range / sensitivity adjuster clockwise to increase sensing range / sensitivity.
 Turn sensing range / sensitivity adjuster counter clockwise to decrease sensing range / sensitivity.
 If the end of the adjustment range is reached, the signal indicator starts flashing with 8 Hz.

Light-on / Dark-on Configuration

Press the light-on / dark-on changeover switch for more than 1 second (less than 4 seconds). The light-on / dark-on mode changes and the operating indicators are activated accordingly.
 If you press the light-on / dark-on changeover switch for more than 4 seconds, the light-on / dark-on mode changes back to the original setting. On release of the light-on / dark-on changeover switch the current state is activated.

Restore Factory Settings

Press the light-on / dark-on changeover switch for more than 10 seconds (less than 30 seconds) until all LEDs turn off. On release of the light-on / dark-on changeover switch the signal indicator turns on. After 5 seconds the sensor resumes operation with factory default settings.

After 5 minutes of inactivity the sensing range / sensitivity adjustment is locked. In order to reactivate the sensing range / sensitivity adjustment, turn the sensing range / sensitivity adjuster for more than 180 degrees.