

AS-Interface splitter box

VAZ-T1-FK-G10-3M-PUR-V1-GV4A



- One piece housing
- Simple and fast mounting
- Stainless steel version, especially suitable for applications in the food industry
- Gold-plated and machined contacts
- Oil- and abrasion-resistant PUR cable
- Immunity to vibration
- Degree of protection IP68 / IP69K
- Halogen-free

G10 junction block, AS-Interface to 1x M12 round plug connector with stainless steel cap nut



Dimensions

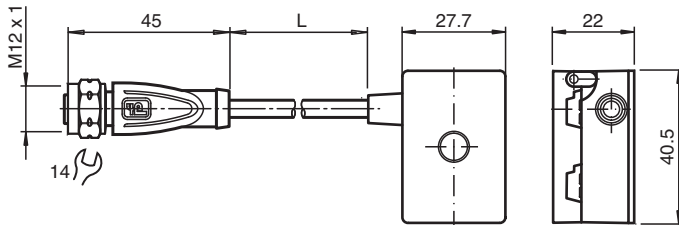

Technical Data

General specifications	
Construction type	Socket, straight Flat cable terminal AS-Interface
Electrical specifications	
Rated operating voltage	$U_e \leq 60 \text{ V PELV}$
Rated operating current	$I_e \leq 4 \text{ A}$
Protection class	III
Surge protection	overvoltage category III
Compliance with standards and directives	
Standard conformity	
Degree of protection	EN 60529:2000
Approvals and certificates	
UL approval	cULus Listed, Type 1 enclosure
Application	for use in NFPA 79 applications
Maximum permissible operating voltage	max. 32 V
Maximum permissible operating current	max. 3 A
Maximum permissible ambient temperature	max. 55 °C (max. 131 °F)
UL File Number	E223772
Ambient conditions	
Ambient temperature	-25 ... 75 °C (-13 ... 167 °F)
Storage temperature	-25 ... 85 °C (-13 ... 185 °F)
Pollution degree	3
Mechanical specifications	
Degree of protection	IP67 IP67 / IP68 / IP69K with flat cable VAZ-FK-S*

Release date: 2024-12-12 Date of issue: 2024-12-12 Filename: 301178_eng.pdf

Technical Data

Connection	Flat cable AS-Interface: cable piercing method Plug connection: M12 x 1 socket (V1)	
Material		
Contacts	CuSn / Au	
Housing	PBT PC	
Body	PUR, black	
Cable	PUR	
Slotted nut	Stainless steel 1.4404 / AISI 316L	
Mounting screw	Stainless steel 1.4305 / AISI 303	
Cable		
Sheath diameter	Ø4,3 mm	
Color	black	
Cores	2 x 0.5 mm ²	
Length	L	3 m
Mass	75 g	
Tightening torque, fastening screws	1.65 Nm	
Dimensions		
Height	22 mm	
Width	27.7 mm	
Length	40.5 mm	
Note	The unused flat cable connector is closed with a seal.	

Connection

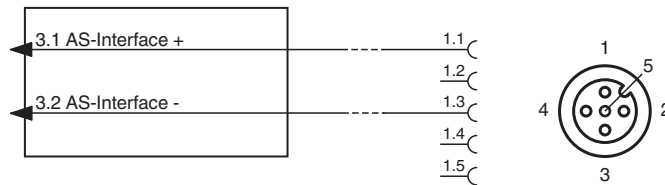

Mounting

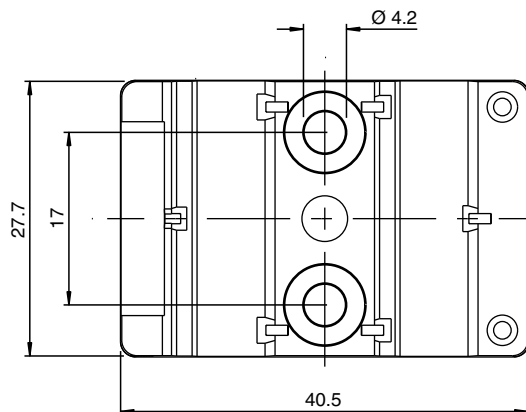

You may screw the device onto a level mounting surface using two M4 attachment screws. The attachment screws are not included.