



## Retroreflective area sensor

RLG28-55-7462



- Retro-reflective area sensor with 6 light beams in standard photoelectric-sensor enclosure
- Connection compatibly replaces single beam photoelectric sensor
- Reliable detection of the front edge of the object irrespective of its shape and position
- Constant object detection from 12 mm within the entire detection area
- Reliable detection of all surfaces irrespective of the object texture
- Switches when contrast difference 10%
- Bright, highly visible transmitter beams guarantee convenient alignment of the sensor

Retroreflective area sensor with 6 beams in a widely used standard photoelectric housing, red light, 4 m detection range, light/dark on switchable, push-pull output, M12 plug



### Function

The RLG28 retro-reflective area sensor contains several transmitters and receivers in one housing and with a reflector positioned opposite forms a 60 mm detection area over a sensing range of 4 m.

When the light beams are interrupted by an object, the switching function is triggered. The smallest detectable object size is 12 mm. The RLG28 switches at a 10% contrast difference with a response time of 1 ms.

**Dimensions**

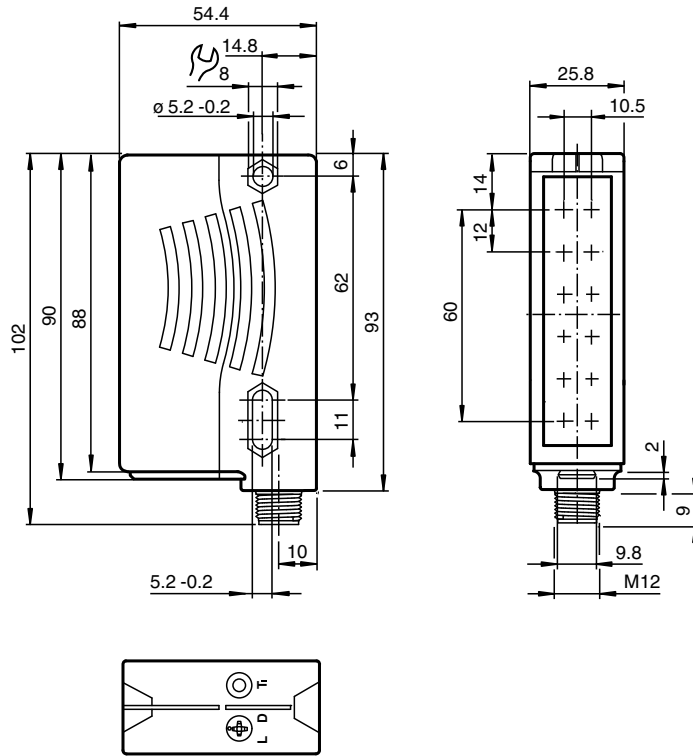

**Technical Data**

General specifications	
Effective detection range	0 ... 4 m
Reflector distance	Reflector A80: 0.4 ... 4 m , H85-2 reflector: 0.2 ... 4 m , Foil reflector OFR-100/100: 0.4 ... 3 m
Threshold detection range	5.6 m
Sensing range	typical 60 mm , Object has to cover the reflector completely in one dimension
Reference target	Reflector A80 H85-2 reflector Foil reflector OFR-100/100
Light source	LED
Light type	modulated visible red light , 625 nm
Polarization filter	yes
Number of beams	6
Diameter of the light spot	approx. 220 mm at detection range 4 m
Opening angle	+/- 2.5 °
Ambient light limit	5000 Lux
Resolution	12 mm
Readjustment	Receiver readjustment active after &t; 30 seconds
Functional safety related parameters	
MTTF <sub>d</sub>	310 a
Mission Time (T <sub>M</sub> )	20 a
Diagnostic Coverage (DC)	0 %
Indicators/operating means	

Release date: 2023-04-04 Date of issue: 2023-04-04 Filename: 302418\_eng.pdf

## Technical Data

Operation indicator		LED green, statically lit Power on Undervoltage indicator: Green LED, pulsing (approx. 0.8 Hz) short-circuit : LED green flashing (approx. 4 Hz)
Function indicator		2 LEDs yellow, light up when light beam is free, flash when falling short of the stability control, off when light beam is interrupted Teach-In : LED yellow/green; equiphase flashing; 2,5 Hz
Control elements		rotary switch for light/dark , Teach-In key
<b>Electrical specifications</b>		
Operating voltage	$U_B$	12 ... 30 V DC
Ripple		max. 10 %
No-load supply current	$I_0$	max. 50 mA
<b>Output</b>		
Stability alarm output		1 Push-pull output, active when there is sufficient operating reserve, inactive when there insufficient operating reserve, alternates for at least 10 s when the signal quality is poor (to check alignment and perform teach-in)
Switching type		light/dark on, switchable
Signal output		1 push-pull (4 in 1) output, short-circuit protected, reverse polarity protected
Switching voltage		max. 30 V DC
Switching current		max. 100 mA
Voltage drop	$U_d$	$\leq 2.5$ V DC
Switching frequency	$f$	230 Hz
Response time		1 ms
<b>Conformity</b>		
Product standard		EN 60947-5-2
<b>Approvals and certificates</b>		
UL approval		E87056 , cULus Listed , class 2 power supply , type rating 1
CCC approval		CCC approval / marking not required for products rated $\leq 36$ V
<b>Ambient conditions</b>		
Ambient temperature		-10 ... 40 °C (14 ... 104 °F)
Storage temperature		-40 ... 70 °C (-40 ... 158 °F)
<b>Mechanical specifications</b>		
Housing width		25.8 mm
Housing height		88 mm
Housing depth		54.3 mm
Degree of protection		IP67
Connection		4-pin, M12 x 1 connector
Material		
Housing		Plastic ABS
Optical face		Plastic pane
Mass		100 g

## Connection Assignment

Option:

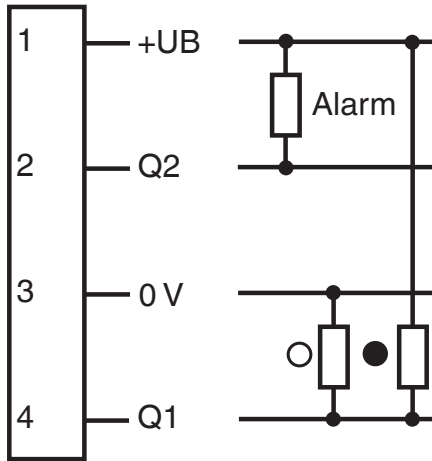

- = Light on
- = Dark on

## Connection Assignment

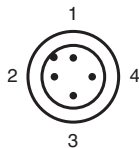

Wire colors in accordance with EN 60947-5-2

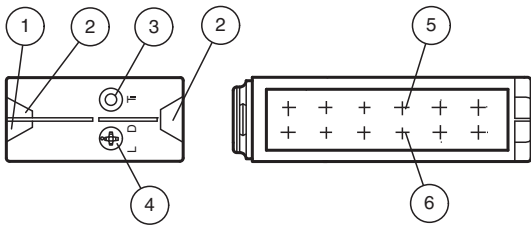

- |   |  |    |         |
|---|--|----|---------|
| 1 |  | BN | (brown) |
| 2 |  | WH | (white) |
| 3 |  | BU | (blue)  |
| 4 |  | BK | (black) |

## Assembly











1	Operating display	green
2	Signal display	yellow
3	TEACH-IN button	
4	Light/dark switch	
5	Emitter	
6	Receiver	

## Accessories

	<b>OMH-05</b>	Mounting aid for round steel ø 12 mm or sheet 1.5 mm ... 3 mm
	<b>OMH-21</b>	Mounting bracket: mounting aid for sensors in the RL* series

Release date: 2023-04-04 Date of issue: 2023-04-04 Filename: 302418\_eng.pdf

## Accessories

	<b>OMH-RLK29-HW</b>	Mounting bracket for rear wall mounting
	<b>OMH-K01</b>	dove tail mounting clamp
	<b>REF-H85-2</b>	Reflector, rectangular 84.5 mm x 84.5 mm, mounting holes
	<b>V1-G-2M-PVC</b>	Female cordset single-ended M12 straight A-coded, 4-pin, PVC cable grey
	<b>V1-G-2M-PUR</b>	Female cordset single-ended M12 straight A-coded, 4-pin, PUR cable grey
	<b>V1-W-2M-PUR</b>	Female cordset single-ended M12 angled A-coded, 4-pin, PUR cable grey
	<b>REF-A80</b>	Reflector, rectangular 80 mm x 50 mm, self-adhesive
	<b>OFR-100/100</b>	Reflective tape 100 mm x 100 mm

**Additional Information**

**Mounting:**

Ensure that the red light transmitted by the sensor fully illuminates the reflector.  
 To ensure optimal detection, the entire 60 mm detection field must appear on the reflector.  
 To check this illumination, look at the reflector from over the top of the sensor housing.



**Teach-in:**

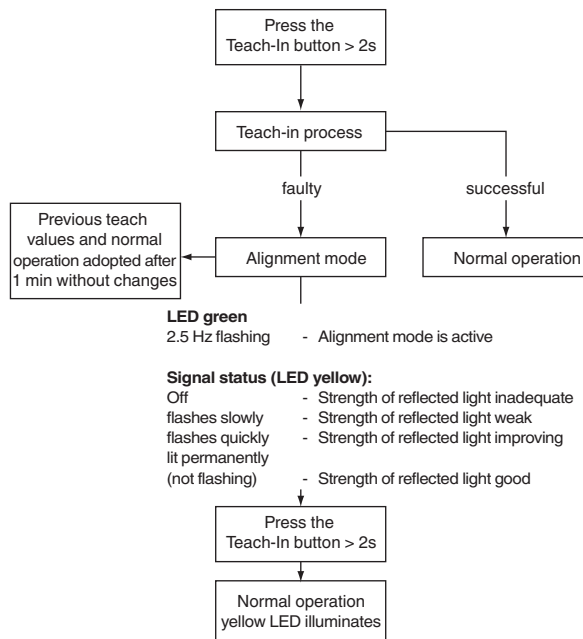

More stringent adjustment requirements: Ensure that the device is correctly aligned in the near range of 0.2 m ... 0.6 m.

**Object detection after successful Teach-in:**

The target should be large enough so that the reflector is always completely covered in one dimension!

