

Thru-beam sensor

BB10-P/25/33/76b/103/115a



- Single-beam miniature photoelectric sensor, ideal for installing in frames or contours
- Integrated circuit
- Plug-in style housing for 13 mm hole
- Narrow opening angle, suitable for mounting in pairs
- Light on version
- Version with test input

Miniature photoelectric sensor with plug-in style housing for mounting in 13 mm hole



Function

There is no simpler way of installing a sensor: drill the hole, clip in the sensor and you're done. What's more, the BB10 plug-in sensors for doors and turnstiles offer top performance at an extremely attractive price. The switching mechanism is integrated in the compact, self-contained and temperature-stable housing, making the BB10 suitable even for extremely cold regions with temperatures as low as -40°C .

Application

- Monitoring function for turnstiles
- Activation function for restarting escalators
- Monitoring of industrial gates
- Person detection for automatic doors and gates

Dimensions

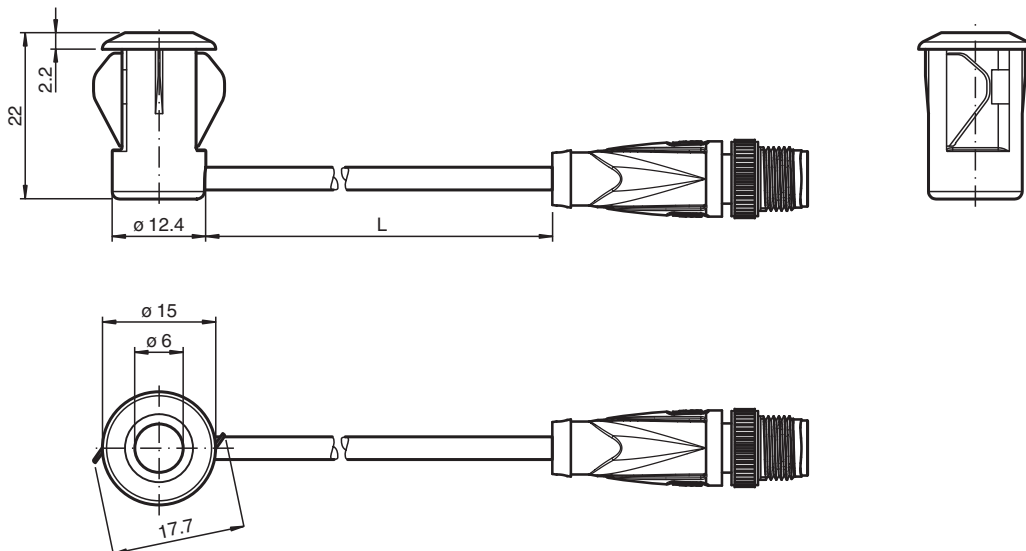

Release date: 2023-05-09 Date of issue: 2023-05-09 Filename: 305982_eng.pdf

Technical Data

System components		
Emitter		BB10-T/33/76b/115e
Receiver		BB10-R/25/33/103/115e
General specifications		
Effective detection range		0 ... 6 m
Threshold detection range		8 m
Light source		IRED
Light type		modulated infrared light , 880 nm
Diameter of the light spot		approx. 1300 mm at a distance of 6 m
Opening angle		Emitter: +/- 8 ° Receiver: +/- 10 °
Optical face		frontal
Ambient light limit		halogen light 100000 Lux ; according to EN 60947-5-2:2007
Accessories provided		7 m PVC cable with 3-pin JST connector
Functional safety related parameters		
MTTF _d		795 a
Mission Time (T _M)		20 a
Diagnostic Coverage (DC)		0 %
Indicators/operating means		
Function indicator		LED red: lights up when receiving the light beam ; flashes when falling short of the operating reserve; OFF when light beam is interrupted
Electrical specifications		
Operating voltage	U _B	10 ... 30 V DC
No-load supply current	I ₀	Emitter: ≤ 20 mA Receiver: ≤ 10 mA
Input		
Test input		emitter deactivation at 0 V
Output		
Switching type		light-on
Signal output		1 PNP output, short-circuit protected, reverse polarity protected, open collector
Switching voltage		max. 30 V DC
Switching current		max. 100 mA
Voltage drop	U _d	≤ 1.5 V DC
Switching frequency	f	62.5 Hz
Response time		8 ms
Conformity		
Product standard		EN 60947-5-2
Approvals and certificates		
CCC approval		CCC approval / marking not required for products rated ≤36 V
Ambient conditions		
Ambient temperature		-40 ... 60 °C (-40 ... 140 °F) , fixed -20 ... 60 °C (-4 ... 140 °F) , movable
Storage temperature		-40 ... 70 °C (-40 ... 158 °F)
Relative humidity		90 % , noncondensing
Mechanical specifications		
Degree of protection		IP67
Connection		with 250 mm fixed cable and M8 connector, 3-pin
Material		
Housing		PC , black
Optical face		Plastic pane
Mass		approx. 100 g per device

Connection Assignment

Option: 103

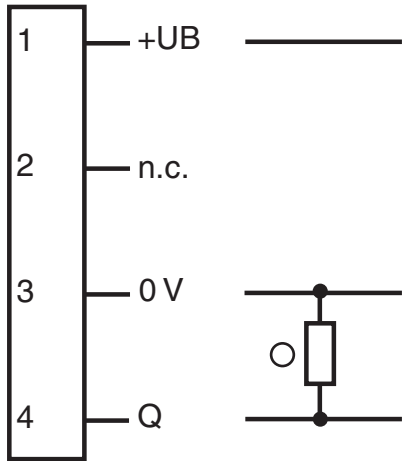

○ = Light on
● = Dark on

Connection Assignment

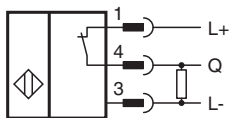
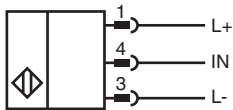

Assembly

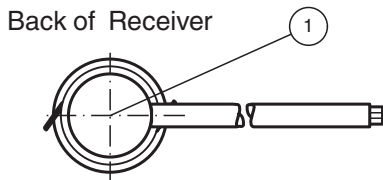

1	Signal display	red
---	----------------	-----

Release date: 2023-05-09 Date of issue: 2023-05-09 Filename: 305982_eng.pdf

Characteristic Curve

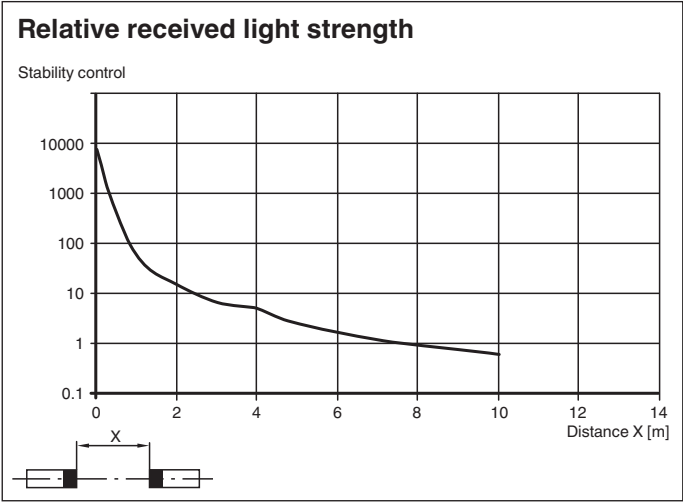
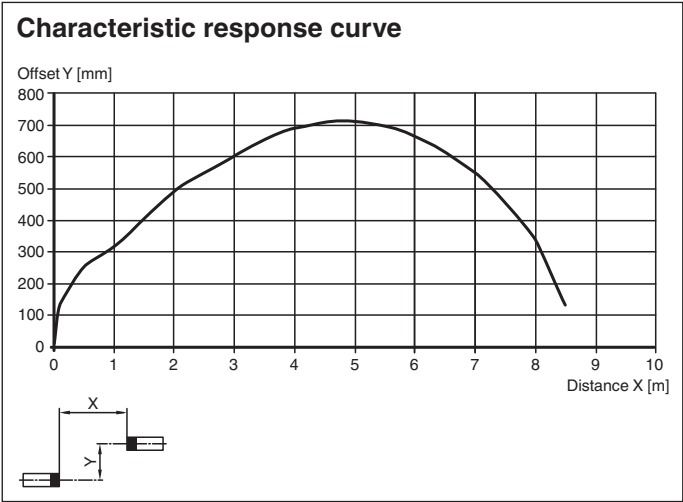

Function Principle

The thru-beam sensor requires two devices for operation; an emitter and a receiver. The emitter and receiver must be optically aligned with one another in a single line. The infrared light emitted from the emitter is recorded by the receiver and evaluated. The sensor detects both people and objects for as long as an object interrupts the detection beam, regardless of movement and surface structure.

Additional Information

Function:

The Series BB10 thru-beam sensor requires a pair of devices for operation, comprising a light transmitter and a light receiver. The transmitter and receiver must be arranged in optical alignment with each other. The infrared light from the transmitter is detected by the receiver and evaluated.

Static detection:

The thru-beam sensor detects persons and objects independently of movement and surface structure for as long as the object breaks the detection beam.

		Electronic output
Light detection /25	Person in the beam	Inactive
	No person in the beam	Active
Dark detection /59	Person in the beam	Active
	No person in the beam	Inactive

Installation:

Thanks to its small dimensions, the light beam can be fitted in a U-profile or behind a face panel.

Sheet thickness [mm]	Hole diameter [mm]	
	13	13.5
1	OK	X
2	OK	OK
3	OK	OK

X = Mounting not possible

OK = Mounting possible

Installation of twin-beam arrangement:

A twin-beam version requires 2 transmitters and receivers.

When using thru-beam sensors with the same transmission frequency:

Ensure that the minimum beam distance is 20 cm and that the light source and receiver are arranged in a cross formation.

