

Inductive sensor

NRB15-30GS50-E2-IO-V1



- 15 mm flush
- Reduction factor = 1
- Magnetic field resistant
- IO-Link interface for service and process data
- Switch point mode or window mode can be set
- Switching function, stability alarm and pulse extension can be set



Function

Reduction factor 1 sensors reliably detect different metals with the same switch state. The integrated IO-Link interface enables clear identification of the sensor and diagnosis of the sensor condition. When using the sensor, parameters and operating modes can be optimally configured specifically for the intended application. In addition to setting the switching function and a pulse extension, the user can select either switch point mode or window mode in combination with a stability alarm. In switch point mode, the stability alarm signals the detection of an object in the area between the assured operating distance and operating distance s_n . In window mode, it signals the detection of an object below the window between operating distance s_n and the nearest operating distance. A stability alarm is displayed to the user via a flashing LED and process data.

Dimensions

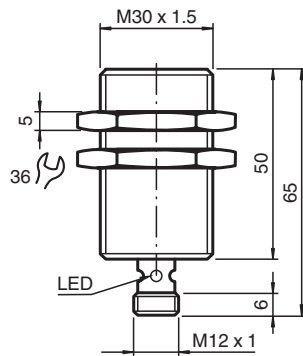

Technical Data

General specifications		
Switching function		Normally open/closed (NO/NC) programmable
Output type		PNP
Rated operating distance	s_n	15 mm (factory setting)
Near operating distance		10 mm (can be activated by software)
Installation		flush
Output polarity		DC
Assured operating distance	s_a	0 ... 12.15 mm
Reduction factor r_{Al}		1
Reduction factor r_{Cu}		1

Release date: 2025-06-10 Date of issue: 2025-06-10 Filename: 306533-0021_eng.pdf

Technical Data

Reduction factor r_{304}		1
Reduction factor r_{317}		1
Output type		3-wire
Nominal ratings		
Operating voltage	U_B	10 ... 30 V DC
Switching frequency	f	0 ... 600 Hz (switch point mode) 0 ... 25 Hz (window mode, switch point mode with stability alarm)
Hysteresis	H	typ. 3 %
Reverse polarity protection		reverse polarity protected
Short-circuit protection		pulsing
Voltage drop	U_d	≤ 0.5 V
Operating current	I_L	0 ... 200 mA
Off-state current	I_r	0 ... 0.5 mA typ. 60 μ A at 25 °C
No-load supply current	I_0	≤ 15 mA
Time delay before availability	t_v	max. 150 ms
Constant magnetic field	B	200 mT
Alternating magnetic field	B	200 mT
Status indicator		Multihole-LED, yellow
Functional safety related parameters		
MTTF _d		362 a
Mission Time (T_M)		20 a
Diagnostic Coverage (DC)		0 %
Interface		
Interface type		IO-Link (via C/Q = pin 4)
IO-Link revision		1.1
Device ID		0x201003 (2101251)
Transfer rate		COM2 (38.4 kBit/s)
Min. cycle time		2.3 ms
Process data width		Process data input (control system side): 2 Bit Process data output (control system side): none
SIO mode support		yes
Compatible master port type		A
Compliance with standards and directives		
Standard conformity		
Standards		EN IEC 60947-5-2
Approvals and certificates		
Protection class		II
Rated insulation voltage	U_i	60 V
Rated impulse withstand voltage	U_{imp}	800 V
UL approval		cULus Listed Load Type: General Purpose Circuitry: Class 2 Power Source Enclosure Type Rating: Type 1 Supply/Switching Voltage: 30 V DC Output Switching Current: 200 mA
CCC approval		CCC approval / marking not required for products rated ≤ 36 V
Ambient conditions		
Ambient temperature		-25 ... 70 °C (-13 ... 158 °F)
Storage temperature		-40 ... 85 °C (-40 ... 185 °F)
Mechanical specifications		
Connection type		Connector plug
Housing material		Stainless steel 1.4305 / AISI 303
Sensing face		PBT
Degree of protection		IP67
Connector		
Threading		M12 x 1

Release date: 2025-06-10 Date of issue: 2025-06-10 Filename: 306533-0021_eng.pdf

Technical Data

Number of pins	3
Mass	153 g
Dimensions	
Length	65 mm
Diameter	30 mm
Factory settings	
Default setting	operating mode = switch point mode with stability alarm switching function = Normally open (NO) switching distance = 15 mm
General information	
Scope of delivery	2 self locking nuts in scope of delivery

Connection

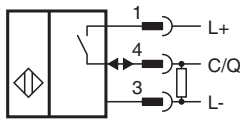

Connection Assignment

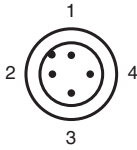

Wire colors in accordance with EN 60947-5-2

1	BN	(brown)
2	WH	(white)
3	BU	(blue)
4	BK	(black)

Function Principle

Switching output modes

Switch point mode at rated operating distance s_n

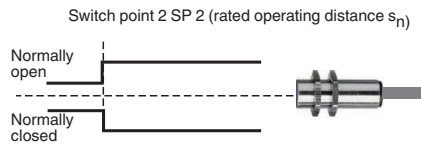

Switch point mode with near operating distance

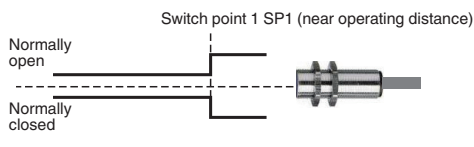

Window mode

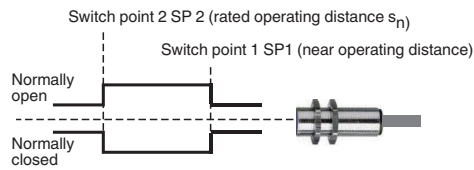

Stability alarm

Switch point mode with stability alarm (factory default)

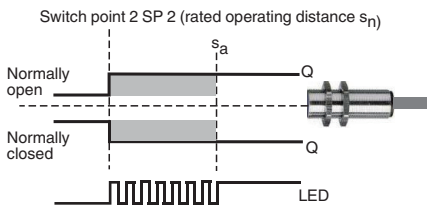

Window mode with stability alarm

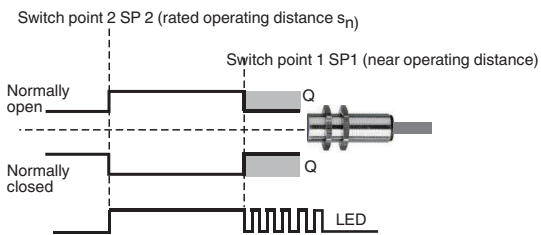

Release date: 2025-06-10 Date of issue: 2025-06-10 Filename: 306533-0021_eng.pdf