

## Inductive sensor NRN40-L3K-E2-IO-C-V1

- 40 mm non-flush
- Reduction factor = 1
- Magnetic field resistant
- Weld Immune
- IO-Link interface for service and process data
- Switch point mode or window mode can be set
- Switching function, stability alarm and pulse extension can be set
- 4-way LED indicator
- Quick mounting bracket



### Function

Reduction factor 1 sensors reliably detect different metals with the same switch state. The integrated IO-Link interface enables clear identification of the sensor and diagnosis of the sensor condition. When using the sensor, parameters and operating modes can be optimally configured specifically for the intended application. In addition to setting the switching function and a pulse extension, the user can select either switch point mode or window mode in combination with a stability alarm. In switch point mode, the stability alarm signals the detection of an object in the area between the assured operating distance and operating distance sn. In window mode, it signals the detection of an object below the window between operating distance sn and the nearest operating distance. A stability alarm is displayed to the user via a flashing LED and process data.

### Dimensions

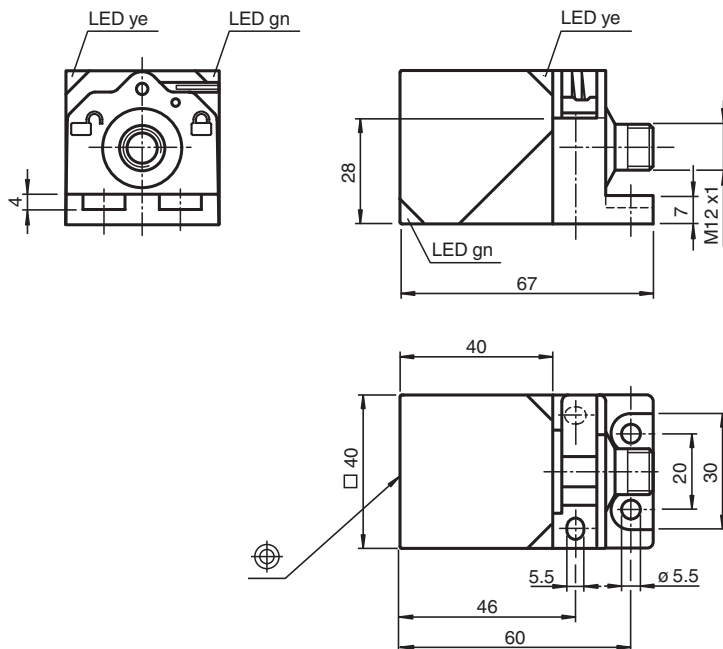

### Technical Data

#### General specifications

Switching function	Normally open/closed (NO/NC) programmable
Output type	PNP

## Technical Data

Rated operating distance	$s_n$	40 mm (factory setting)
Near operating distance		35 mm (can be activated by software)
Installation		non-flush
Output polarity		DC
Assured operating distance	$s_a$	0 ... 32.4 mm
Reduction factor $r_{Al}$		1
Reduction factor $r_{Cu}$		1
Reduction factor $r_{304}$		1
Reduction factor $r_{Si37}$		1
Output type		3-wire
<b>Nominal ratings</b>		
Operating voltage	$U_B$	10 ... 30 V DC
Switching frequency	$f$	0 ... 180 Hz (switch point mode) 0 ... 30 Hz (window mode, switch point mode with stability alarm)
Hysteresis	$H$	typ. 3 %
Reverse polarity protection		reverse polarity protected
Short-circuit protection		pulsing
Voltage drop	$U_d$	$\leq 0.5$ V
Operating current	$I_L$	0 ... 200 mA
Off-state current	$I_r$	0 ... 0.5 mA typ. 60 $\mu$ A at 25 °C
No-load supply current	$I_o$	$\leq 20$ mA
Time delay before availability	$t_v$	max. 150 ms
Constant magnetic field	$B$	200 mT
Alternating magnetic field	$B$	200 mT
Operating voltage indicator		LED, green
Status indicator		LED, yellow
<b>Functional safety related parameters</b>		
MTTF <sub>d</sub>		701 a
Mission Time ( $T_M$ )		20 a
Diagnostic Coverage (DC)		0 %
<b>Interface</b>		
Interface type		IO-Link ( via C/Q = pin 4 )
IO-Link revision		1.1
Device ID		0x201004 (2101252)
Transfer rate		COM2 (38.4 kBit/s)
Min. cycle time		2.3 ms
Process data width		Process data input (control system side): 2 Bit Process data output (control system side): none
SIO mode support		yes
Compatible master port type		A
<b>Compliance with standards and directives</b>		
Standard conformity		
Standards		EN IEC 60947-5-2
<b>Approvals and certificates</b>		
Protection class		II
Rated insulation voltage	$U_i$	60 V
Rated impulse withstand voltage	$U_{imp}$	800 V
UL approval		cULus Listed Load Type: General Purpose Circuitry: Class 2 Power Source Enclosure Type Rating: Type 1 Supply/Switching Voltage: 30 V DC Output Switching Current: 200 mA
CCC approval		CCC approval / marking not required for products rated $\leq 36$ V
<b>Ambient conditions</b>		
Ambient temperature		-25 ... 70 °C (-13 ... 158 °F)

Release date: 2025-06-11 Date of issue: 2025-06-11 Filename: 306534-0002\_eng.pdf

## Technical Data

Storage temperature	-40 ... 85 °C (-40 ... 185 °F)
<b>Mechanical specifications</b>	
Connection type	Connector plug
Housing material	GD-ZnAl4Cu1, coated mounting flange PA6-GF35
Sensing face	PA 6 Grivory GVN-35H
Degree of protection	IP67
Connector	
Threading	M12 x 1
Number of pins	4
Mass	190 g
Dimensions	
Height	40 mm
Width	40 mm
Length	67 mm
<b>Factory settings</b>	
Default setting	operating mode = switch point mode with stability alarm switching function = Normally open (NO) switching distance = 40 mm

## Connection

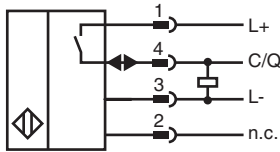

## Connection Assignment

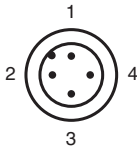

Wire colors in accordance with EN 60947-5-2

1	BN	(brown)
2	WH	(white)
3	BU	(blue)
4	BK	(black)

**Function Principle**

**Switching output modes**

**Switch point mode at rated operating distance  $s_n$**

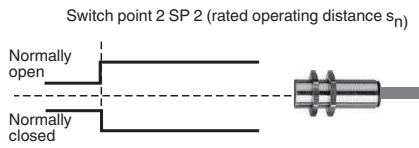

**Switch point mode with near operating distance**

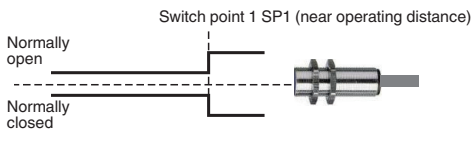

**Window mode**

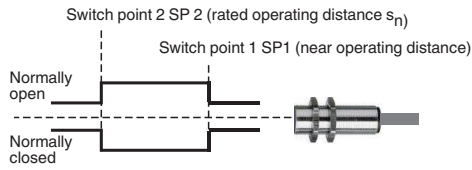

**Stability alarm**

**Switch point mode with stability alarm (factory default)**

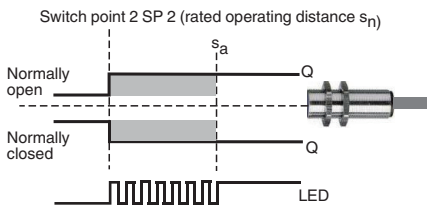

**Window mode with stability alarm**

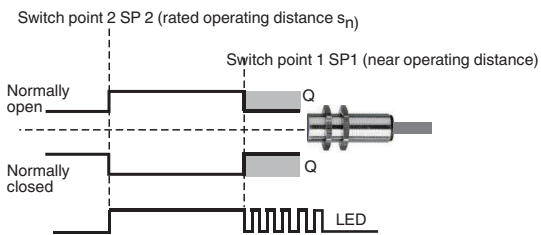

Release date: 2025-06-11 Date of issue: 2025-06-11 Filename: 306534-0002\_eng.pdf