

## Cable gland

### CP-CGL-SLT-1/4-M16 5pcs

- Suitable for 1/4" flexible coated conduit



Cable gland M16 for cable diameter 1 ... 5.2 mm and 1/4" flexible coated conduit

## Function

The cable gland is used in conjunction with a suitable flexible conduit and a suitable sensor adapter to form a cable protection system for sensors. The purpose of this system is to protect the sensor wiring in harsh environments.

## Dimensions

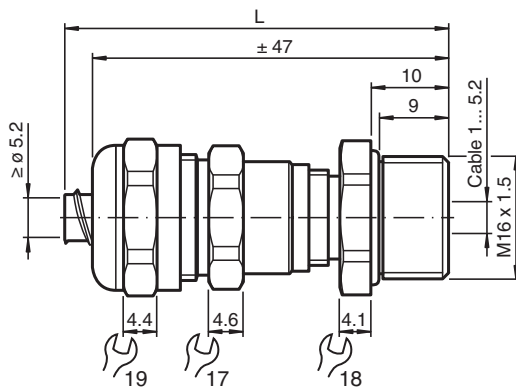

## Technical Data

### Mechanical specifications

Clamping range (D)







Seal insert

outer seal: for cable diameter 4 ... 5.2 mm  
outer seal + inner seal: for cable diameter 1 ... 4 mm

## Technical Data

Thread type	metric
Thread size	M16 x 1.5
Degree of protection	IP65
Material	
Cable gland	brass, nickel-plated
Seal	Seal two-piece , synthetic rubber EDPM V0
Clamping ring	PVC
O-Ring	NBR
Mass	46 g
<b>General information</b>	
Supplementary information	observe mounting instructions

## Matching system components

	<b>CP-CDT-SLT-1/4-10M</b>	1/4" flexible coated conduit 10 m
	<b>CP-ADP-SLT-1/4-M8 5pcs</b>	Sensor adapter for M8 sensors and 1/4" flexible coated conduit
	<b>CP-ADP-SLT-1/4-M12 5pcs</b>	Sensor adapter for M12 sensors and 1/4" flexible coated conduit
	<b>CP-ADP-SLT-1/4-M14 5pcs</b>	Sensor adapter for M14 sensors and 1/4" flexible coated conduit
	<b>LOCKNUT M16 NICKEL BRASS</b>	Nut, nickel-plated brass
	<b>LOCKNUT M8 NICKEL BRASS</b>	Nut, nickel-plated brass