



Multitrans absolute encoder DVM58N-011AGR0BY-1213

- Industrial standard housing $\varnothing 58$ mm
- 25-bit multitrans
- Galvanically isolated DeviceNet interface
- Clamping flange
- Auto-saving function



Function

Absolute encoders deliver an absolute step value for each angle setting. All these values are represented by code samples on one or more code disks. The code disks are screened by an infrared LED and the bit obtained sample is detected by an optical array. Its signals are electronically amplified and are forwarded on to the interface for processing. The bus electronics module is integrated into the removable housing cover. This makes it possible to mount or replace the new rotary encoders and the matching bus electronics separately during installation or service.

Dimensions

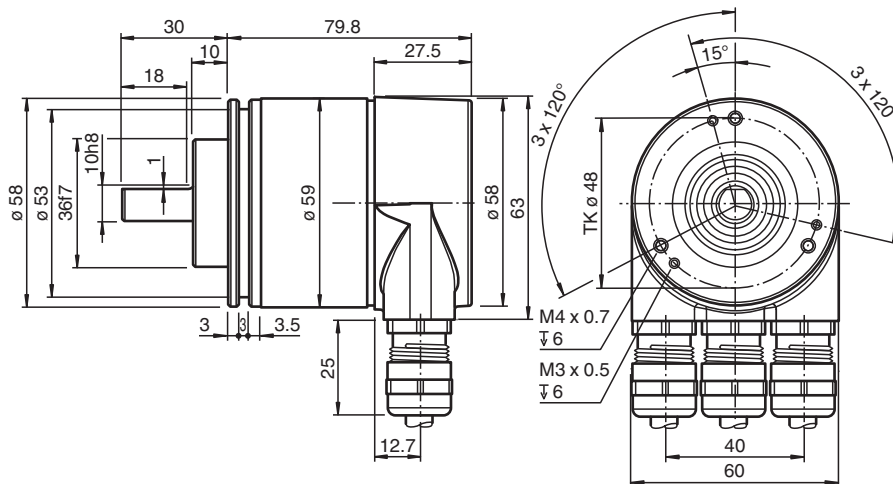

Technical Data

General specifications

Detection type	photoelectric sampling
Device type	Multitrans absolute encoder

Functional safety related parameters

MTTF _d	480 a at 40 °C
Mission Time (T _M)	20 a
L ₁₀	4.3 E-10 at 6000 rpm and 20/40 N axial/radial shaft load
Diagnostic Coverage (DC)	0 %

Electrical specifications

Operating voltage	U _B	10 ... 30 V DC
No-load supply current	I ₀	max. 230 mA at 10 V DC max. 100 mA at 24 V DC

Release date: 2022-12-12 Date of issue: 2022-12-12 Filename: 308150_eng.pdf

Technical Data

Linearity	± 2 LSB at 16 Bit, ± 1 LSB at 13 Bit, $\pm 0,5$ LSB at 12 Bit
Output code	binary code
Code course (counting direction)	cw ascending (clockwise rotation, code course ascending) cw descending (clockwise rotation, code course descending)
Interface	
Interface type	DeviceNet
Resolution	
Single turn	13 Bit
Multiturn	12 Bit
Overall resolution	25 Bit
Transfer rate	max. 0.5 MBit/s
Connection	
Terminal compartment	in removable housing cover
Standard conformity	
Degree of protection	DIN EN 60529, IP65
Climatic testing	DIN EN 60068-2-30 , no moisture condensation
Emitted interference	DIN EN 61000-6-4
Noise immunity	DIN EN 61000-6-2
Shock resistance	DIN EN 60068-2-27, 100 g, 6 ms
Vibration resistance	DIN EN 60068-2-6, 20 g, 10 ... 2000 Hz
Approvals and certificates	
UL approval	cULus Listed, General Purpose, Class 2 Power Source
Ambient conditions	
Operating temperature	-40 ... 85 °C (-40 ... 185 °F)
Storage temperature	-40 ... 85 °C (-40 ... 185 °F)
Mechanical specifications	
Material	housing: powder coated aluminum flange: aluminum shaft: stainless steel
Mass	approx. 700 g
Rotational speed	max. 12000 min ⁻¹
Moment of inertia	30 gcm ²
Starting torque	≤ 3 Ncm
Shaft load	
Axial	40 N
Radial	110 N

Connection

Terminal	Explanation
⊥	Ground connection for power supply
(+)	Power supply
(-)	Power supply
CG	CAN ground
CL	CAN low
CH	CAN high
CG	CAN ground
CL	CAN low
CH	CAN high

Configuration

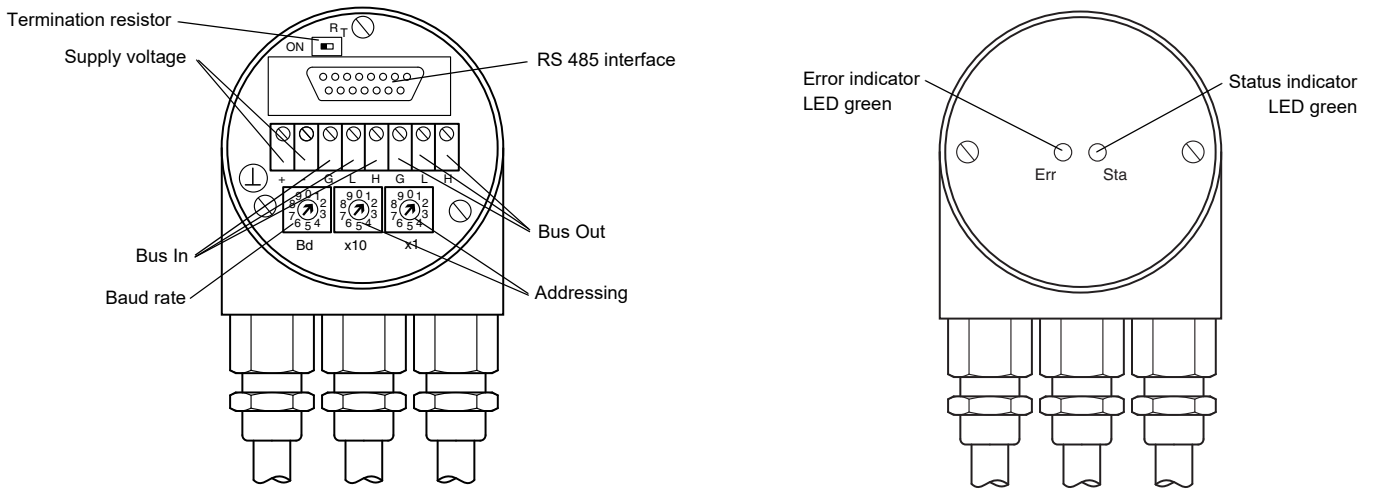

Adjusting the participant address

The participant address can be adjusted with the rotary switches. The address can be defined between 1 and 63, and may only be assigned once.

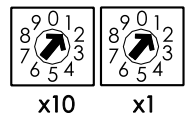

Adjusting the termination resistor

The terminating resistor R_T (121 Ω) can be connected to the circuit by means of the switch:

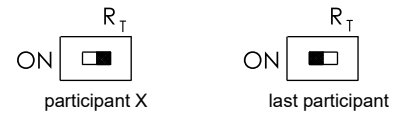

Baud rate adjustment

Baud rate [kBit/s]	Switch position
125	0
250	1
500	2
125	3
reserved	4 ... 9

LED-indicators

LED red	LED green	Meaning
off	off	No voltage supply
off	on	Encoder ready, boot-up message not transmitted, yet. Possible reasons: - no further participant present - wrong baud rate - encoder in prepared status
flashing	on	Boot-up message transmitted, Device configuration possible.
on	on	Normal operation mode, encoder in operational status.

Release date: 2022-12-12 Date of issue: 2022-12-12 Filename: 308150_eng.pdf

Parameterization

CAN operating mode

The operating mode of this encoder is set to „Polled mode“. The connected host requests the current actual position value via a telegram. The absolute encoder reads in the current position, calculates all parameters that may have been set and then sends back the actual process value.

Programmable rotary encoder parameters

Parameter	Explanation
Operating parameter	The direction of rotation (complement) can be specified by parameter as the operating parameter. This parameter determines the direction of rotation in which the output code will be rising or descending.
Resolution per revolution	The "Resolution" parameter is used to program the rotary encoder so that a desired number of steps can be implemented in reference to a revolution.
Overall resolution	This parameter indicates the desired number of measurement units of the entire travel length. This value must not exceed the overall resolution of the absolute encoder. If the absolute encoder is used in infinite mode, the overall resolution parameter can only take on values that are powers of 2 (2x).
Preset value	The preset value is the desired position value that must be achieved for a specific physical setting of the axis. The preset value parameter is used to set the actual position value to the desired actual process value.

Device specific encoder parameters

Class code: 66 Hex

Instance: 01 Hex

Auto-saving function

Attribute ID	Access	Name	Data type	Description
92 hex	Get/Set	Code sequence	Boolean	Controls the code sequence clockwise or counterclockwise
93 hex	Get/Set	Resolution per revolution	INT	Resolution for one revolution
94 hex	Get/Set	Total resolution	DINT	Total measurable resolution
95 hex	Get/Set	Preset value	DINT	Setting a defined position value
96 hex	Get	Position value	DINT	Current position

This encoder saves the programmed parameters directly from the configuration tool into the non-volatile memory. No additional command is required.

Type Code

Order code

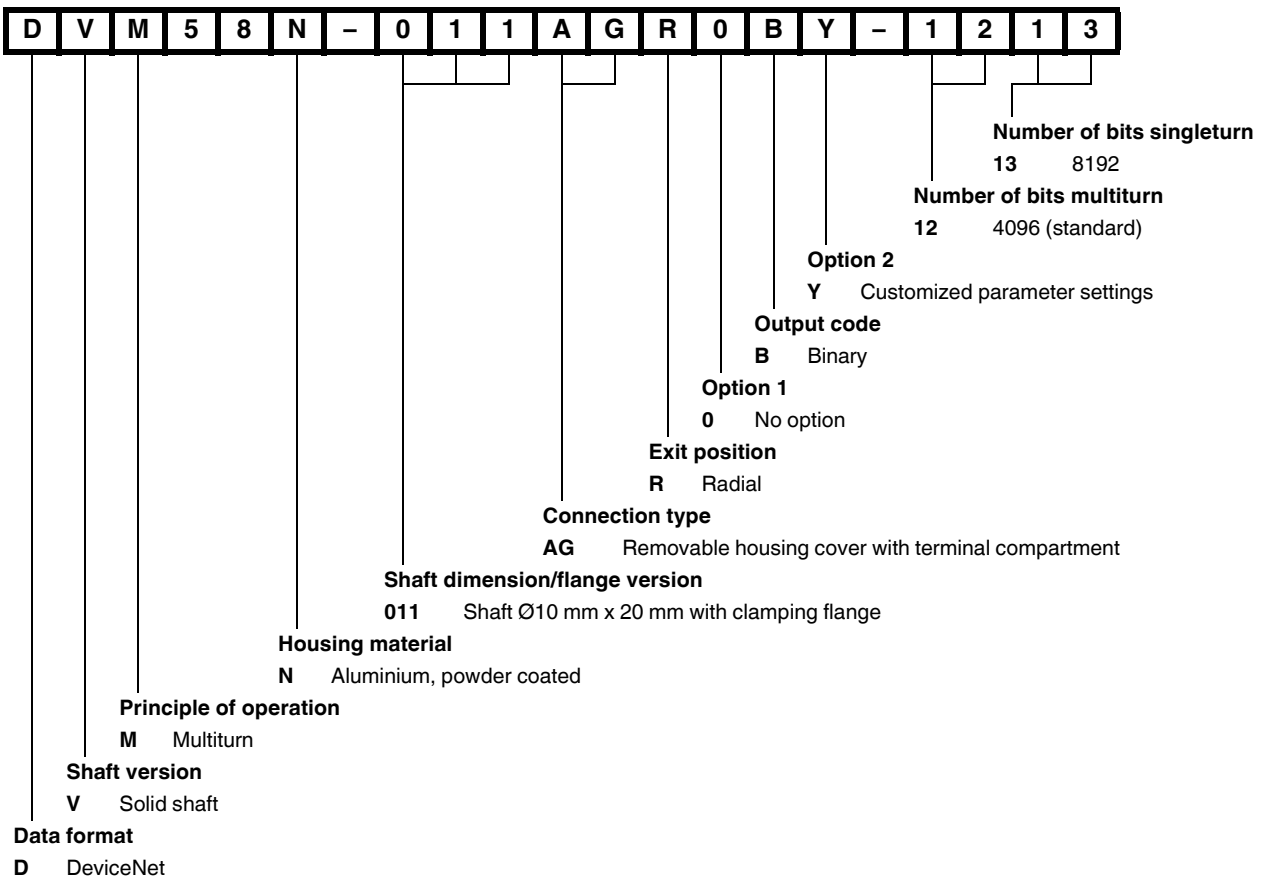

Release date: 2022-12-12 Date of issue: 2022-12-12 Filename: 308150_eng.pdf

Installation

Anti-interference measures

The use of highly sophisticated microelectronics requires a consistently implemented anti-interference and wiring concept. This becomes all the more important the more compact the constructions are and the higher the demands are on the performance of modern machines.

The following installation instructions and proposals apply for "normal industrial environments". There is no ideal solution for all interfering environments.

When the following measures are applied, the encoder should be in perfect working order:

- Termination of the serial line with a 120 Ω resistor (between Receive/Transmit and Receive/Transmit) at the beginning and end of the serial line (e. g. the control and the last encoder).
- The wiring of the encoder should be laid at a large distance to energy lines which could cause interferences.
- Cable cross-section of the screen at least 4 mm².
- Cable cross-section at least 0,14 mm².
- The wiring of the screen and 0 V should be arranged radially, if and when possible.
- Do not kink or jam the cables.
- Adhere to the minimum bending radius as given in the data sheet and avoid tensile as well as shearing load.

Operating instructions

Every encoder manufactured by Pepperl+Fuchs leaves the factory in a perfect condition. In order to ensure this quality as well as a faultless operation, the following specifications have to be taken into consideration:

- Avoid any impact on the housing and in particular on the encoder shaft as well as the axial and radial overload of the encoder shaft.
- The accuracy and service life of the encoder is guaranteed only, if a suitable coupling is used.
- The operating voltage for the encoder and the follow-up device (e. g. control) has to be switched on and off simultaneously.
- Any wiring work has to be carried out with the system in a dead condition.
- The maximum operating voltages must not be exceeded. The devices have to be operated at extra-low safety voltage.

Notes on connecting the electric screening

The immunity to interference of a plant depends on the correct screening. In this field installation faults occur frequently. Often the screen is applied to one side only, and is then soldered to the earthing terminal with a wire, which is a valid procedure in LF engineering. However, in case of EMC the rules of HF engineering apply.

One basic goal in HF engineering is to pass the HF energy to earth at an impedance as low as possible as otherwise energy would discharge into the cable. A low impedance is achieved by a large-surface connection to metal surfaces.

The following instructions have to be observed:

- Apply the screen on both sides to a "common earth" in a large surface, if there is no risk of equipotential currents.
- The screen has to be passed behind the insulation and has to be clamped on a large surface below the tension relief.
- In case of cable connections to screw-type terminals, the tension relief has to be connected to an earthed surface.
- If plugs are used, metallised plugs only should be fitted (such as sub D plugs with metallised housing). Please observe the direct connection of the tension relief to the housing.

Advantage:	metallised connector, shield
relief	clamped with the strain clamp
Disadvantage:	soldering shield on

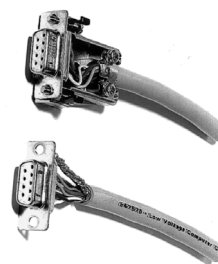

Safety instructions

Please observe the national safety and accident prevention regulations as well as the subsequent safety instructions in these operating instructions when working on encoders.

If failures cannot be remedied, the device has to be shut down and has to be secured against accidental operation.

Repairs may be carried out only by the manufacturer. Entry into and modifications of the device are not permissible.

Tighten the clamping ring only, if a shaft has been fitted in the area of the clamping ring (hollow shaft encoders).

Tighten all screws and plug connectors prior to operating the encoder.

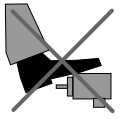

Do not stand on the encoder!

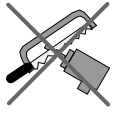

Do not remachine the drive shaft!



Avoid impact!



Do not remachine the housing!