



Locknuts

LN.M63.BN.K10

- Brass nickel-plated
- Thread M63
- Packaging unit: 10 pieces

Dimensions

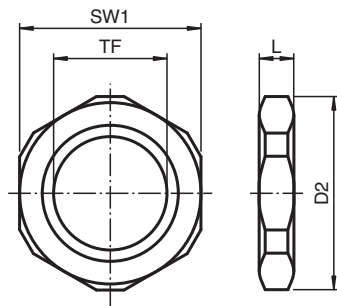

Dimension values see data table.
Image and drawing are generic for this component type and may deviate from the specific variant.

Legend	
D2	Width across corners
L	Total length
SW1	Width across flats
TF	Thread size female

Technical Data













Mechanical specifications	
Thread type	metric ISO pitch 1.5 mm
Thread size female (TF)	M63
Material	brass, nickel-plated
Finish	inherent color silver
Dimensions	
Width across corners (D2)	77 mm

Release date: 2020-06-02 Date of issue: 2020-06-02 Filename: 312481_eng.pdf

Technical Data

Width across flats (SW1)	70 mm
Total length (L)	6 mm
General information	
Delivery quantity	10
Scope of delivery	Locknuts

Matching system components

	CG.AR.M63.SS.C.20.K02
	CG.AR.M63.BN.C.20.K02
	CG.CO.M63.BN.C.18.K02
	CG.NA.M63.BN.C.18.K02
	CG.NA.M63S.BN.C.18.K04
	CG.NA.M63.SS.C.18.K02
	CG.NA.M63S.SS.C.18.K04
	AD.M63.M50.BN.C.18.K12
	AD.M63.NPT2.BN.C.18.K12
	AD.M63.NPT2.SS.C.18.K12
	SP.MD.M63.BN.C.17.K05
	SP.MD.M63.SS.C.17.K05
	SP.PE.M63.PA.C.18.K05