

washer gasket WA.FL.M20.F.K100

- For thread M20
- Packaging unit: 100 pieces

Dimensions

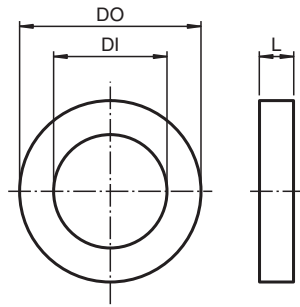

Dimension values see data table.
Image and drawing are generic for this component type and may deviate from the specific variant.

Legend	
DO	Outer diameter
DI	Inside diameter
L	Total length

Technical Data

Mechanical specifications

Material	aramid fibers bonded with NBR
Finish	inherent color green
Dimensions	
Outer diameter (DO)	23.8 mm
Inside diameter (DI)	20.1 mm
Total length (L)	1.5 mm
General information	
Delivery quantity	100



















Release date: 2020-06-02 Date of issue: 2020-06-02 Filename: 312496_eng.pdf

Technical Data

Scope of delivery

washer gasket

Matching system components

	CG.AR.M20L.SS. C.16.K15	
	CG.AR.M20.SS.C.16.K15	
	CG.AR.M20L.BN. C.16.K15	
	CG.AR.M20.BN.C.16.K15	
	CG.CO.M20.BN.C.16.K15	
	CG.EM.M20.BN.C.18.K50	
	CG.EM.M20.SS.C.18.K50	
	CG.NA.M20.BN.C.16.K50	
	CG.NA.M20S.BN. C.16.K50	
	CG.NA.M20.SS.C.16.K50	
	CG.NA.M20S.SS. C.16.K50	
	AD.M20.M16.BN. C.15.K63	
	AD.M20.NPT1/2.BN. C.15.K35	
	AD.M20.NPT1/2.SS. C.15.K35	
	AD.M20.NPT3/4.BN. C.15.K35	
	AD.M20.NPT3/4.SS. C.15.K35	
	SP.MD.M20.BN.C.15.K50	
	SP.MD.M20.SS.C.15.K50	

Release date: 2020-06-02 Date of issue: 2020-06-02 Filename: 312496_eng.pdf