

washer gasket

WA.FL.M25.F.K100

- For thread M25
- Packaging unit: 100 pieces

Dimensions

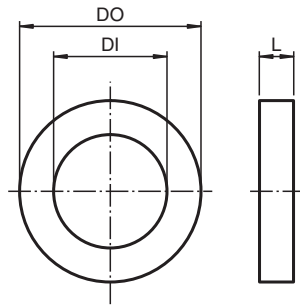

Dimension values see data table.
Image and drawing are generic for this component type and may deviate from the specific variant.

Legend	
DO	Outer diameter
DI	Inside diameter
L	Total length

Technical Data

Mechanical specifications

Material	aramid fibers bonded with NBR
Finish	inherent color green
Dimensions	
Outer diameter (DO)	32.2 mm
Inside diameter (DI)	25.1 mm
Total length (L)	1.5 mm
General information	
Delivery quantity	100



















Release date: 2020-06-02 Date of issue: 2020-06-02 Filename: 312497_eng.pdf

Technical Data

Scope of delivery

washer gasket

Matching system components

	CG.AR.M25S.BN. C.16.K10	
	CG.AR.M25S.SS. C.16.K10	
	CG.AR.M25L.BN. C.16.K10	
	CG.AR.M25.SS.C.16.K10	
	CG.AR.M25L.SS. C.16.K10	
	CG.AR.M25.BN.C.16.K10	
	CG.CO.M25.BN.C.16.K10	
	CG.EM.M25.BN.C.16.K25	
	CG.EM.M25.SS.C.16.K25	
	CG.NA.M25.BN.C.16.K15	
	CG.NA.M25S.BN. C.16.K25	
	CG.NA.M25.SS.C.16.K15	
	CG.NA.M25S.SS. C.16.K25	
	AD.M25.M20.BN. C.15.K35	
	AD.M25.NPT1.BN. C.15.K35	
	AD.M25.NPT1.SS. C.15.K35	
	AD.M25.NPT1/2.BN. C.15.K35	
	AD.M25.NPT1/2.SS. C.15.K35	
	AD.M25.NPT3/4.BN. C.15.K35	

Release date: 2020-06-02 Date of issue: 2020-06-02 Filename: 312497_eng.pdf

Matching system components

AD.M25.NPT3/4.SS.
C.15.K35



SP.MD.M25.BN.C.15.K50



SP.MD.M25.SS.C.15.K50