

washer gasket

WA.FL.M40.F.K50

- For thread M40
- Packaging unit: 50 pieces

Dimensions

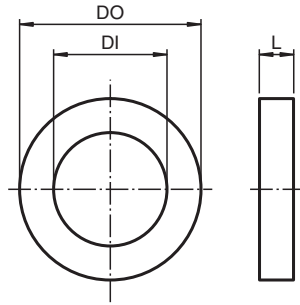

Dimension values see data table.
Image and drawing are generic for this component type and may deviate from the specific variant.

Legend	
DO	Outer diameter
DI	Inside diameter
L	Total length

Technical Data

Mechanical specifications

Material	aramid fibers bonded with NBR
Finish	inherent color green
Dimensions	
Outer diameter (DO)	49.6 mm
Inside diameter (DI)	40.1 mm
Total length (L)	1.5 mm
General information	
Delivery quantity	50















Release date: 2020-06-02 Date of issue: 2020-06-02 Filename: 312499_eng.pdf

Technical Data

Scope of delivery

washer gasket

Matching system components

	CG.AR.M40.SS.C.16.K10
	CG.AR.M40.BN.C.16.K05
	CG.CO.M40.BN.C.18.K05
	CG.EM.M40.BN.C.20.K05
	CG.EM.M40.SS.C.20.K05
	CG.NA.M40S.BN. C.18.K05
	CG.NA.M40S.SS. C.18.K05
	AD.M40.M32.BN. C.18.K20
	AD.M40.NPT1-1/2.BN. C.18.K20
	AD.M40.NPT1-1/2.SS. C.18.K20
	AD.M40.NPT1-1/4.BN. C.18.K20
	AD.M40.NPT1-1/4.SS. C.18.K20
	SP.MD.M40.BN.C.17.K10
	SP.MD.M40.SS.C.17.K10