

## washer gasket

WA.FL.M63.F.K50

- For thread M63
- Packaging unit: 50 pieces

### Dimensions

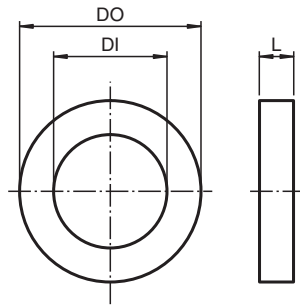

Dimension values see data table.  
Image and drawing are generic for this component type and may deviate from the specific variant.

Legend	
DO	Outer diameter
DI	Inside diameter
L	Total length

### Technical Data

#### Mechanical specifications

Material	aramid fibers bonded with NBR
Finish	inherent color green
Dimensions	
Outer diameter (DO)	78.4 mm
Inside diameter (DI)	63.2 mm
Total length (L)	1.5 mm
General information	
Delivery quantity	50













Release date: 2020-06-02 Date of issue: 2020-06-02 Filename: 312504\_eng.pdf

## Technical Data

Scope of delivery

washer gasket

## Matching system components

	CG.AR.M63.SS.C.20.K02
	CG.AR.M63.BN.C.20.K02
	CG.CO.M63.BN.C.18.K02
	CG.NA.M63.BN.C.18.K02
	CG.NA.M63S.BN.C.18.K04
	CG.NA.M63.SS.C.18.K02
	CG.NA.M63S.SS.C.18.K04
	AD.M63.M50.BN.C.18.K12
	AD.M63.NPT2.BN.C.18.K12
	AD.M63.NPT2.SS.C.18.K12
	SP.MD.M63.BN.C.17.K05
	SP.MD.M63.SS.C.17.K05