



Reader with protective housing

WCS3B-LS510H-OM

- EtherNet/IP
- Non-contact, absolute position encoder
- Automatic detection of dirt accumulation
- Output of position and speed
- For outdoor use
- Extended temperature range

Reader with protective enclosure, EtherNet/IP interface



Dimensions

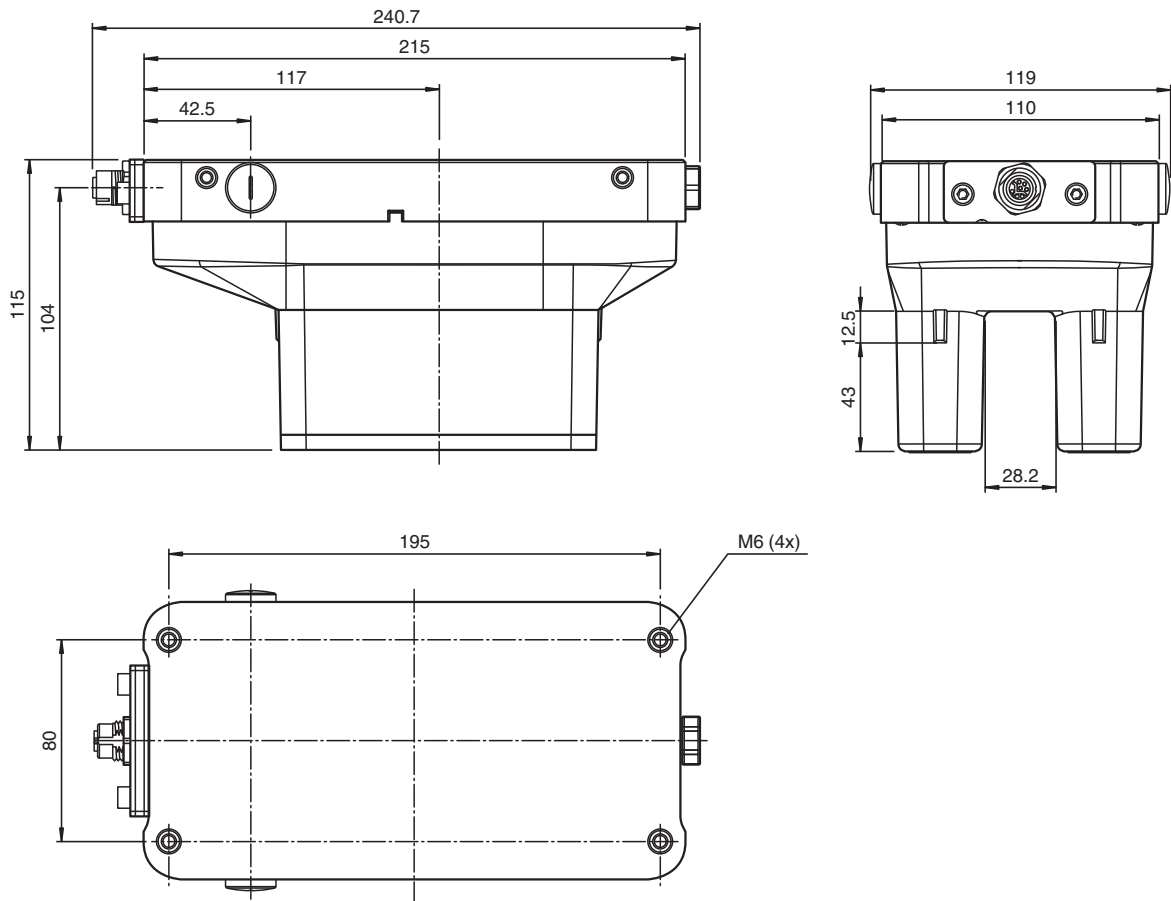

Technical Data

General specifications

Passage speed	v	≤ 12.5 m/s
Measuring range		max. 314.5 m

Release date: 2022-10-20 Date of issue: 2022-10-20 Filename: 312680_eng.pdf







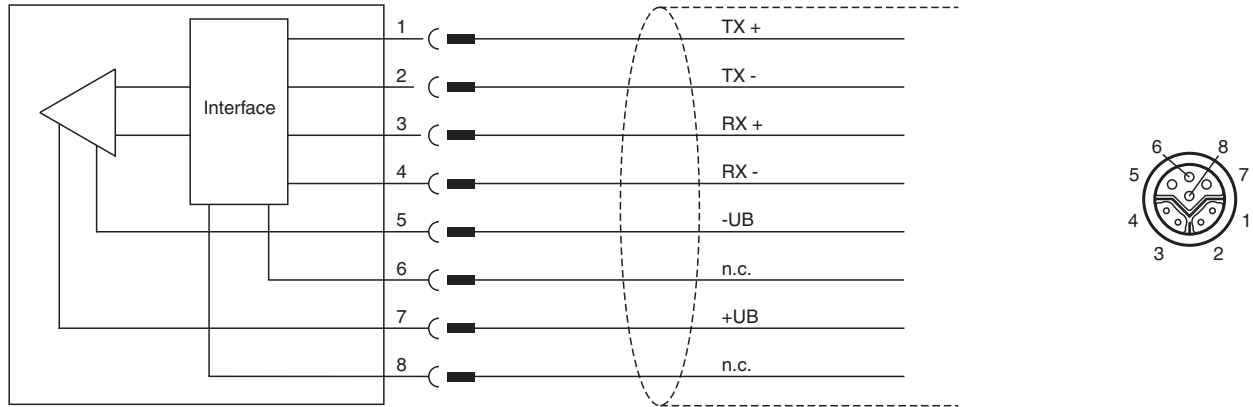



Technical Data

Free tolerances to code rail	horizontal: 28 mm (± 14 mm) vertical: 25.5 mm (+11.5 mm/-14 mm)	
Resolution	± 0.4 mm (1,250 positions/m)	
Functional safety related parameters		
MTTF _d	55 a	
Mission Time (T _M)	10 a	
Diagnostic Coverage (DC)	0 %	
Indicators/operating means		
LED green	ETHERNET link To: ETHERNET connection OK	
LED yellow	ETHERNET Bus Activity Flashing: data transfer	
LED red	ETHERNET communication To: communication error	
LED red/green	Status indication Green: code rail detected, normal function Red: system error Flashing red: no code rail detected	
Electrical specifications		
Operating voltage	U _B	10 ... 30 V DC
Power consumption	P ₀	15 W
Interface		
Interface type	100 BASE-TX	
Data output code	binary code	
Protocol	EtherNet/IP	
Transfer rate	100 MBit/s	
Standard conformity		
Emitted interference	EN 61000-6-4:2007+A1:2011	
Noise immunity	EN 61000-6-2:2005	
Shock resistance	EN 60068-2-27:2009	
Vibration resistance	EN 60068-2-6:2008	
Approvals and certificates		
CSA approval	cCSAus Certified, General Purpose Class 2 power source	
CCC approval	CCC approval / marking not required for products rated ≤36 V	
Ambient conditions		
Operating temperature	-40 ... 60 °C (-40 ... 140 °F)	
Storage temperature	-40 ... 85 °C (-40 ... 185 °F)	
Mechanical specifications		
Connection type	8-pin, M12 x 1 connector socket, Y-coded	
Degree of protection	IP67 / IP69	
Material		
Housing	PET , PC (Polycarbonate)	
Mass	1000 g	
Note	The reader must not be operated without the protective housing!	

Connection



Accessories

	V19SY-G-BK10M-PUR-ABG	Male single-ended cordset, M12, 8-pin, Y encryption, PUR cable, shielded
	V45-G	Male connector RJ45 straight 4-pin, Cat5, shielded, field-attachable
	WCS3B-OPC	Outdoor protective cover for WCS3B reader
	V45-GP	Male connector RJ45 straight 4-pin, Cat5, shielded, field-attachable, Outdoor
	V15S-W-ABG-PG9	Male connector M12 angled A-coded 5-pin, for cable diameter 5 - 8 mm, shielded, field-attachable
	V15S-G-ABG-PG9	Male connector M12 straight A-coded 5-pin, for cable diameter 5 - 8 mm, shielded, field-attachable
	WCS3B-OBP	Stopping plugs For WCS3B-OP* housing
	V1SD-G-5M-PUR-ABG-V45-G	Connection cable, M12 to RJ-45, PUR cable 4-pin, CAT5e
	V19SY-Y-V1D/V1S	Y-Splitter M12 plug 8-pin Y-coded to M12 socket 4-pin D-coded / M12 plug 4-pin A-coded
	V19SY-G-BK*M-PUR-ABG	Ethernet bus cable male cordset single-ended M12 straight Y-coded 8-pin, PUR cable black, Cat5e, shielded, drag chain suitable

Release date: 2022-10-20 Date of issue: 2022-10-20 Filename: 312680_eng.pdf