

Universal holder

MH V3-Holder

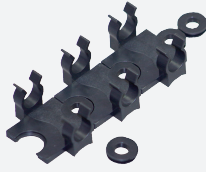

- Modular universal holder
- Free from substances that impair paint wetting

Modular universal holder for M8 connectors

Dimensions

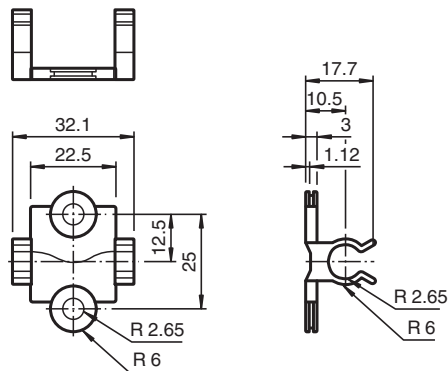

Technical Data

Ambient conditions	
Installation temperature	-25 ... 85 °C (-13 ... 185 °F)
Mechanical specifications	
Connection	9 mm
Installation	Distance between mounting holes: 25 mm
Note	Packaging unit, 10-piece

Release date: 2020-03-24 Date of issue: 2020-06-30 Filename: 318647_eng.pdf

Mounting

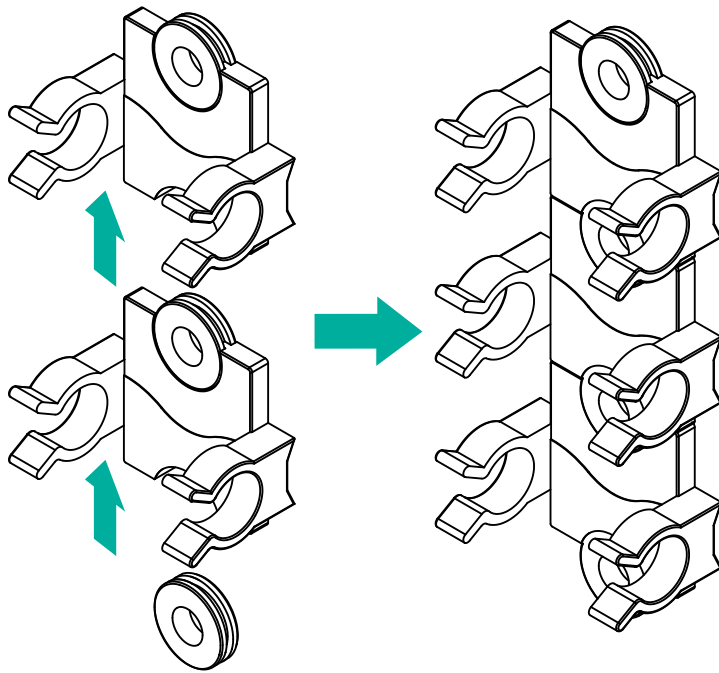

Release date: 2020-03-24 Date of issue: 2020-06-30 Filename: 318647_eng.pdf