

## Switch Amplifier KCD2-SON-Ex2.R2

- 2-channel isolated barrier
- 24 V DC supply (Power Rail)
- Dry contact or NAMUR inputs
- Application-specific outputs
- 2 passive transistor outputs (resistive)
- Line fault transparency (LFT)
- Housing width 12.5 mm
- Up to SIL 2 (SC 3) acc. to IEC/EN 61508



**SIL 2**



### Function

This isolated barrier is used for intrinsic safety applications. The device transfers digital signals from NAMUR sensors or dry contacts from the hazardous area to the non-hazardous area. Each input controls a passive transistor output with a resistive output characteristic. The outputs have three defined states: 1-signal = 5 k $\Omega$ , 0-signal = 15 k $\Omega$  and fault > 100 k $\Omega$ . This output characteristic offers line fault transparency on the signal lines. Via switches the mode of operation can be reversed and the line fault detection can be switched off. A fault is signaled by LEDs and a separate collective error message output.

### Connection

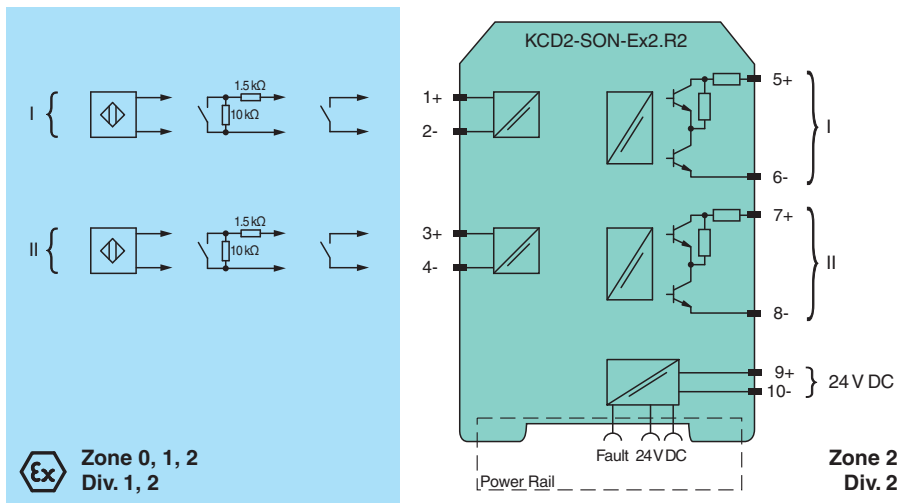

### Technical Data

General specifications	
Signal type	Digital Input
Functional safety related parameters	
Safety Integrity Level (SIL)	SIL 2
Systematic capability (SC)	SC 3
Supply	
Connection	Power Rail or terminals 9+, 10-
Rated voltage	$U_r$ 19 ... 30 V DC
Ripple	$\leq 10 \%$
Rated current	$I_r$ 35 ... 25 mA

Release date: 2023-01-03 Date of issue: 2023-01-03 Filename: 320094\_eng.pdf

## Technical Data

Power dissipation		≤ 750 mW
<b>Input</b>		
Connection side		field side
Connection		terminals 1+, 2-; 3+, 4-
Rated values		acc. to EN 60947-5-6 (NAMUR)
Open circuit voltage/short-circuit current		approx. 10 V DC / approx. 8 mA
Switching point/switching hysteresis		1.2 ... 2.1 mA / approx. 0.2 mA
Line fault detection		breakage $I \leq 0.1$ mA , short-circuit $I \geq 6.5$ mA
Pulse/Pause ratio		min. 100 $\mu$ s / min. 100 $\mu$ s
<b>Output</b>		
Connection side		control side
Connection		output I: terminals 5, 6 ; output II: terminals 7, 8
Rated voltage	$U_r$	19 ... 30 V DC
Response time		≤ 200 $\mu$ s
Output I, II		signal or fault message, passive transistor output (resistive) 0-signal: 15 k $\Omega$ $\pm$ 5 % 1-signal: 5 k $\Omega$ $\pm$ 5 % fault: > 100 k $\Omega$
Collective error message		Power Rail
<b>Transfer characteristics</b>		
Switching frequency		≤ 5 kHz
<b>Galvanic isolation</b>		
Input/Output		reinforced insulation acc. to EN 50178, rated insulation voltage 300 V <sub>eff</sub>
Input/power supply		reinforced insulation acc. to EN 50178, rated insulation voltage 300 V <sub>eff</sub>
Output/power supply		basic insulation according to EN 50178, rated insulation voltage 50 V <sub>eff</sub>
Output/Output		basic insulation according to EN 50178, rated insulation voltage 50 V <sub>eff</sub>
<b>Indicators/settings</b>		
Display elements		LEDs
Control elements		DIP switch
Configuration		via DIP switches
Labeling		space for labeling at the front
<b>Directive conformity</b>		
Electromagnetic compatibility		
Directive 2014/30/EU		EN 61326-1:2013 (industrial locations)
<b>Conformity</b>		
Electromagnetic compatibility		NE 21:2011 , EN 61326-3-2:2008
Degree of protection		IEC 60529:2001
Protection against electrical shock		IEC 61010-1:2010
Input		EN 60947-5-6:2000
<b>Ambient conditions</b>		
Ambient temperature		-20 ... 60 °C (-4 ... 140 °F) extended ambient temperature range up to 70 °C (158 °F), refer to manual for necessary mounting conditions
<b>Mechanical specifications</b>		
Degree of protection		IP20
Connection		screw terminals
Mass		approx. 100 g
Dimensions		12.5 x 119 x 114 mm (0.5 x 4.7 x 4.5 inch) (W x H x D) , housing type A2
Mounting		on 35 mm DIN mounting rail acc. to EN 60715:2001
<b>Data for application in connection with hazardous areas</b>		
EU-type examination certificate		BASEEFA 13 ATEX 0080
Marking		⊕ II (1)G [Ex ia Ga] IIC ⊕ II (1)D [Ex ia Da] IIIC ⊕ I (M1) [Ex ia Ma] I
Input		Ex ia
Voltage	$U_o$	10.5 V

**Technical Data**

Current	$I_o$	17.1 mA
Power	$P_o$	45 mW (linear characteristic)
<b>Supply</b>		
Maximum safe voltage	$U_m$	253 V AC (Attention! $U_m$ is no rated voltage.)
<b>Output</b>		
Maximum safe voltage	$U_m$	253 V AC (Attention! The rated voltage can be lower.)
Certificate	CML 19 ATEX 4410 X	
Marking	Ⓜ II 3G Ex ec IIC T4 Gc	
<b>Galvanic isolation</b>		
Input/Output	safe electrical isolation acc. to IEC/EN 60079-11, voltage peak value 375 V	
Input/power supply	safe electrical isolation acc. to IEC/EN 60079-11, voltage peak value 375 V	
<b>Directive conformity</b>		
Directive 2014/34/EU	EN IEC 60079-0:2018 , EN 60079-7:2015+A1:2018 , EN 60079-11:2012	
<b>International approvals</b>		
<b>UL approval</b>		
Control drawing	116-0374 (cULus)	
<b>IECEX approval</b>		
IECEX certificate	IECEX BAS 13.0046 IECEX CML 19.0147X	
IECEX marking	[Ex ia Ga] IIC , [Ex ia Da] IIIC , [Ex ia Ma] I Ex ec IIC T4 Gc	
<b>General information</b>		
Supplementary information	Observe the certificates, declarations of conformity, instruction manuals, and manuals where applicable. For information see <a href="http://www.pepperl-fuchs.com">www.pepperl-fuchs.com</a> .	

**Assembly**

Front view

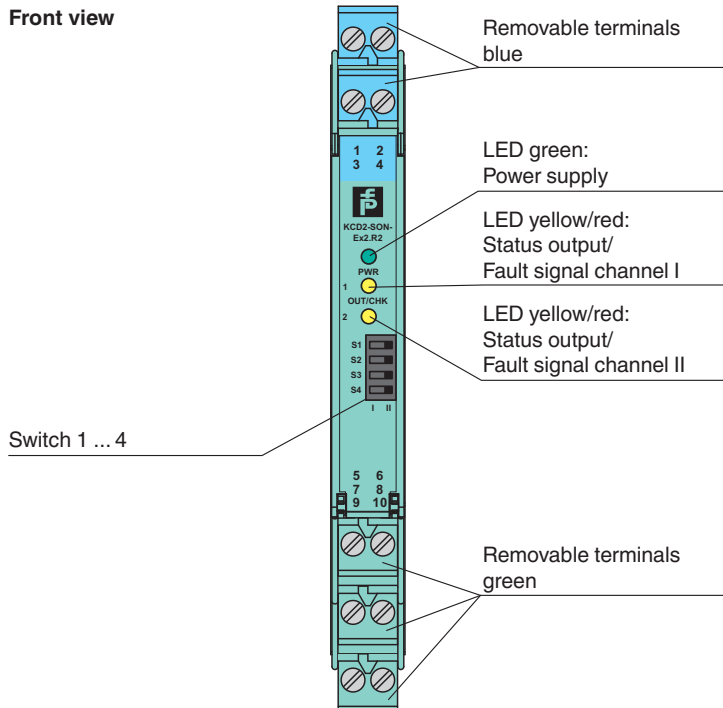





**Matching System Components**





	<b>KFD2-EB2</b>	Power Feed Module
---	-----------------	-------------------

Release date: 2023-01-03 Date of issue: 2023-01-03 Filename: 320094\_eng.pdf

## Matching System Components

	<b>UPR-03</b>	Universal Power Rail with end caps and cover, 3 conductors, length: 2 m
	<b>UPR-03-M</b>	Universal Power Rail with end caps and cover, 3 conductors, length: 1,6 m
	<b>UPR-03-S</b>	Universal Power Rail with end caps and cover, 3 conductors, length: 0.8 m
	<b>K-DUCT-BU</b>	Profile rail, wiring comb field side, blue
	<b>K-DUCT-BU-UPR-03</b>	Profile rail with UPR-03- * insert, 3 conductors, wiring comb field side, blue

## Accessories

	<b>F-NR3-Ex1</b>	NAMUR Resistor Network
	<b>KC-ST-5GN</b>	Terminal block for KC modules, 2-pin screw terminal, green
	<b>KC-ST-5BU</b>	Terminal block for KC modules, 2-pin screw terminal, blue
	<b>KF-CP</b>	Red coding pins, packaging unit: 20 x 6

## Application

This device is compatible to the control:

- Honeywell Safety Manager RIO I.S.

Compatibility check to other ESD/DCS systems on request.

## Configuration

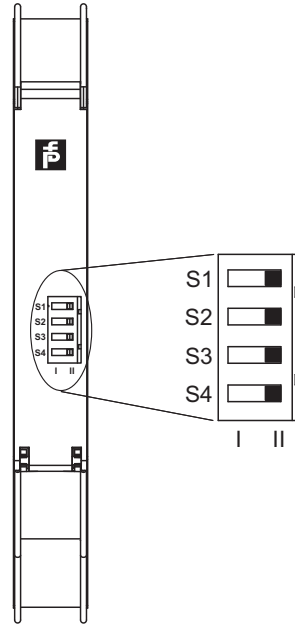

### Switch settings

S	Function		Position
1	Mode of operation output I (active)	with high input current	I
		with low input current	II
2	Mode of operation output II (active)	with high input current	I
		with low input current	II
3	Line fault detection of the input I	ON	I
		OFF	II
4	Line fault detection of the input II	ON	I
		OFF	II

### Operating states

Control circuit	Input signal
Initiator high impedance/contact opened	low input current
Initiator low impedance/contact closed	high input current
Lead breakage, lead short circuit	Line fault

Factory setting: switch 1, 2, 3 and 4 in position I

## Characteristic Curve

### Switching points

Release date: 2023-01-03 Date of issue: 2023-01-03 Filename: 320094\_eng.pdf

