

Inductive sensor

NBB15-30GM50-A2-V1

- 15 mm flush
- Increased operating distance
- Extended temperature range
-40 ... +85 °C
- Extended operating voltage range
- Flexible use with versatile mounting opportunities



Dimensions

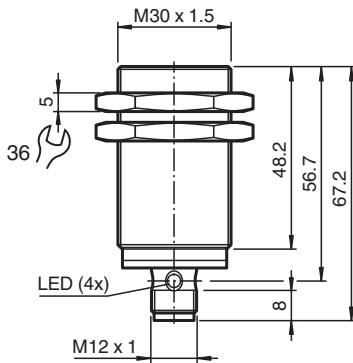

Technical Data

General specifications

Switching function		complementary
Output type		PNP
Rated operating distance	s_n	15 mm
Installation		flush
Output polarity		DC
Assured operating distance	s_a	0 ... 12.15 mm
Actuating element		mild steel, e. g. 1.0037, SR235JR (formerly St37-2) 45 mm x 45 mm x 1 mm
Reduction factor r_{Al}		0.45
Reduction factor r_{Cu}		0.43
Reduction factor r_{304}		0.73
Reduction factor r_{Brass}		0.53
Output type		4-wire

Nominal ratings

Operating voltage	U_B	6 ... 36 V
Switching frequency	f	0 ... 550 Hz
Hysteresis	H	typ. 5 %
Reverse polarity protection		reverse polarity protected
Short-circuit protection		pulsing

Release date: 2025-07-07 Date of issue: 2025-07-07 Filename: 326161-0148_eng.pdf

Technical Data

Voltage drop	U_d	≤ 1 V
Operating current	I_L	0 ... 200 mA
Off-state current	I_r	max. 20 μ A
No-load supply current	I_0	≤ 15 mA
Time delay before availability	t_v	≤ 10 ms
Switching state indicator		Multihole-LED, yellow
Functional safety related parameters		
MTTF _d		1027 a
Mission Time (T _M)		20 a
Diagnostic Coverage (DC)		0 %
Conformity		
PWIS conformity		VDMA 24364-A1/B2/C1/T100°C-W
Compliance with standards and directives		
Standard conformity		
Standards		EN IEC 60947-5-2
Approvals and certificates		
Protection class		II
Rated insulation voltage	U_i	36 V
Rated impulse withstand voltage	U_{imp}	500 V
UL approval		cULus Listed, General Purpose, Class 2 Power Source
CCC approval		CCC approval / marking not required for products rated ≤ 36 V
Marine approval		DNVGL TAA00003AK
Ambient conditions		
Ambient temperature		-40 ... 85 °C (-40 ... 185 °F)
Storage temperature		-40 ... 85 °C (-40 ... 185 °F)
Mechanical specifications		
Connection type		Connector plug
Housing material		brass , white bronze coated
Sensing face		PBT , green
Degree of protection		IP65 / IP66 / IP67 / IP68
Connector		
Threading		M12 x 1
Number of pins		4
Mass		156 g
Dimensions		
Length		67 mm
Diameter		30 mm
Mounting		with nuts, M30
Tightening torque		≤ 30 Nm
General information		
Scope of delivery		2 self locking nuts in scope of delivery

Connection Assignment

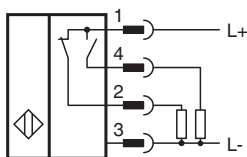

Connection Assignment



Wire colors in accordance with EN 60947-5-2

1	BN	(brown)
2	WH	(white)
3	BU	(blue)
4	BK	(black)

Characteristic Curve

Actuation by radial approach (standard target)

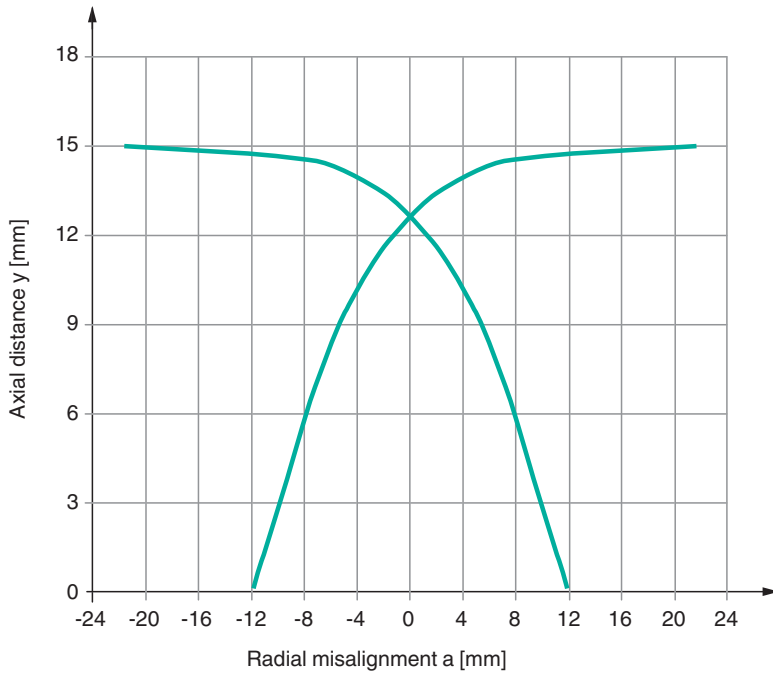

Switching distance depending on the actuating element

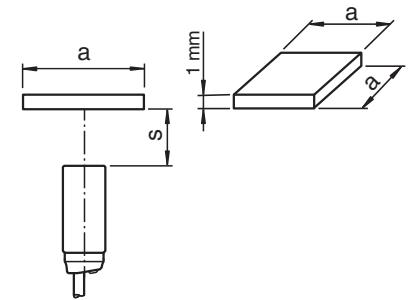
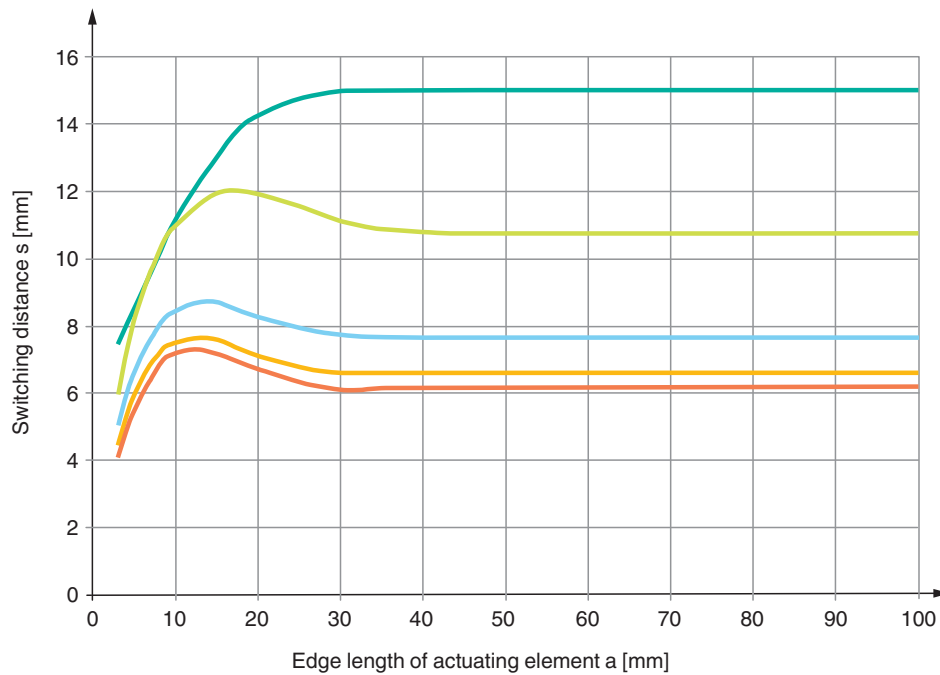

- Steel
- Stainless steel
- Brass
- Aluminum
- Copper

Release date: 2025-07-07 Date of issue: 2025-07-07 Filename: 326161-0148_eng.pdf