



Cable Glands, Metal, for non-armored Cables

CG.NA.NPT1S.BN.C.20.K15

- For cables without armor
- Brass nickel-plated
- Thread NPT 1"
- Seal chloroprene
- Ex db, Ex eb and Ex tb certified
- Suitable for operation in Zone 1, Zone 2, Zone 21 and Zone 22
- Suitable for operation in Class I, Zone 1/2/22
- Suitable for operation in Class I, Division 2 when installed in accordance with NEC501.10(B)(2)
- Degree of protection IP66 / IP68, UL Type 4X
- Packaging unit: 15 pieces, without accessories



Dimensions



Dimensions

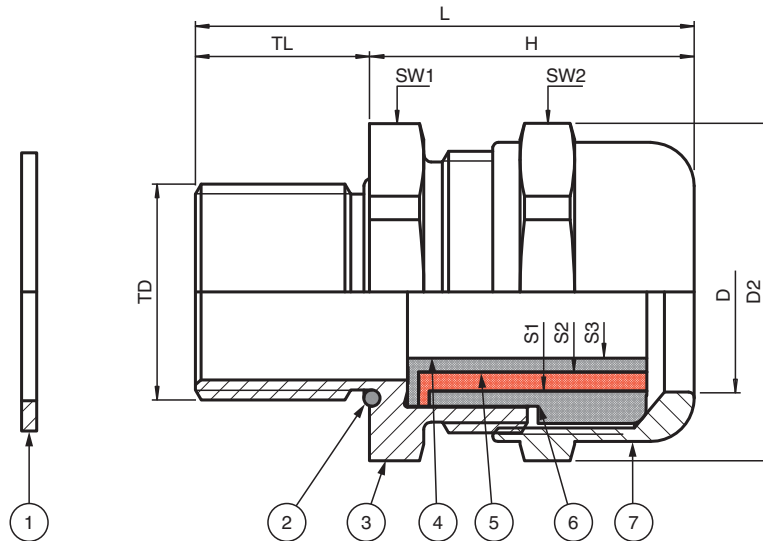

Details see data table

Legend	
1	Washer gasket (accessory)
2	O-Ring
3	Gland body basis
4	Seal insert S3
5	Seal insert S2
6	Seal insert S1
7	Cap nut
D	Clamping range, cable sheath diameter
D2	Width across corners
H	Length outside enclosure
L	Total length
S*	Clamping range, seal insert combinations
SW*	Width across flats
TD	Thread size
TL	Thread length

Release date: 2023-10-17 Date of issue: 2023-10-17 Filename: 400786_eng.pdf

Technical Data

Mechanical specifications

Technical Data

Cable type	non-armored cables
Clamping range (D)	14 ... 24 mm
Seal combination S1	20 ... 24 mm
Seal combination S1+S2	17 ... 20 mm
Seal combination S1+S2+S3	14 ... 17 mm
Thread type	NPT ANSI ASME B1.20.1
Thread size (TD)	NPT 1"
Degree of protection	IP66 / IP68 , UL Type 4X
Material	
Finish	inherent color silver
Cable gland	brass, nickel-plated
Washer gasket	aramid fibers bonded with NBR
O-Ring	chloroprene
Seal insert	chloroprene
Mass	
Individual component	approx. 134 g
Packing unit	approx. 2.21 kg
Dimensions	
Width across corners (D2)	39 mm
Diameter thru-hole (DT)	33.5 ... 33.7 mm
Length outside enclosure (H)	35 mm
Width across flats (SW1)	35 mm
Width across flats (SW2)	35 mm
Thread length (TL)	20 mm
Total length (L)	55 mm
Tightening torque	
Nut torque at enclosure (SW1)	8 Nm
Nut torque 2 with seal S1 (SW2)	20 Nm
Nut torque 2 with seals S1+S2 (SW2)	23 Nm
Nut torque 2 with seals S1+S2+S3 (SW2)	28 Nm
Ambient conditions	
Ambient temperature	-40 ... 80 °C (-40 ... 176 °F) washer gasket -40 ... 80 °C (-40 ... 176 °F)
Data for application in connection with hazardous areas	
EU-type examination certificate	IMQ 14 ATEX 012X
Marking	Ⓜ II 2 GD Ex db IIC Gb Ex eb IIC Gb Ex tb IIC Db
International approvals	
UL approval	
cULus	E490324 tested to UL 514B E490962 tested to UL 2225 CSA 60079-7 , CSA 60079-31
IECEx approval	IECEx IMQ 14.0004X
UKCA approval	CML 21 UKEX 11380X
INMETRO approval	DNV 20.0029 X
CCC approval	2021312313000344
Conformity	
Degree of protection	EN 60529
General information	
Delivery quantity	15
Scope of delivery	Cable glands Brief instructions (1 copy)
Supplementary information	EC-Type Examination Certificate, Statement of Conformity, Declaration of Conformity, Attestation of Conformity and instructions have to be observed where applicable. For information see www.pepperl-fuchs.com .

Technical Data**Accessories**

Sealing plugs

BP.NA.M25-M32S.PA