



Adapter

AD.M20.M16.BN.C.15.K63

- Adapter male thread metric to female thread metric
- Brass nickel-plated
- Thread M20
- Thread M16
- Seal chloroprene
- Ex db, Ex eb and Ex tb certified
- Suitable for operation in Zone 1, Zone 2, Zone 21 and Zone 22
- Packaging unit: 63 pieces, without accessories



Assembly

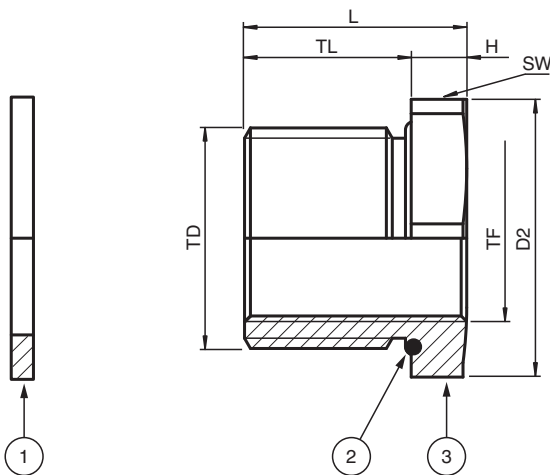
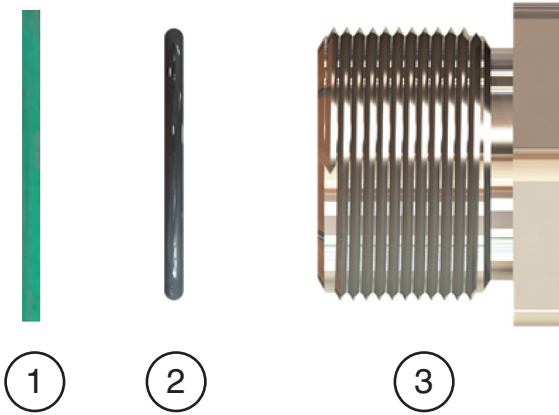

Assembly

Details see data table

Legend	
1	Washer gasket (accessory, metric threads only)
2	O-Ring (metric threads only)
3	Adapter
DI	Diameter internal hole
D2	Width across corners
H	Length outside enclosure
L	Total length
SW*	Width across flats
TD	Thread size
TF	Thread size female
TL	Thread length
TLF	Thread length female

Technical Data

Mechanical specifications

Thread type	metric ISO pitch 1.5 mm
Thread size (TD)	M20
Thread type female	metric ISO pitch 1.5 mm
Thread size female (TF)	M16
Degree of protection	IP66 / IP68
Material	
Finish	inherent color silver
Washer gasket	aramid fibers bonded with NBR
Adapter	brass, nickel-plated
O-Ring	chloroprene

Mass

Individual component	approx. 39 g
Packing unit	approx. 2.7 kg

Dimensions

Width across corners (D2)	27.5 mm
Length outside enclosure (H)	4 mm
Width across flats (SW1)	25 mm
Thread length (TL)	15 mm
Thread length female (TLF)	19 mm
Total length (L)	19 mm

Tightening torque

Nut torque at enclosure (SW1)	6 Nm
-------------------------------	------

Ambient conditions

Ambient temperature	-40 ... 100 °C (-40 ... 212 °F) washer gasket -40 ... 80 °C (-40 ... 176 °F)
---------------------	---

Data for application in connection with hazardous areas

EU-type examination certificate	CESI 15 ATEX 029X
Marking	Ⓜ II 2 GD Ex db IIC Gb Ex eb IIC Gb Ex tb IIIC Db

International approvals

IECEX approval	IECEX CES 15.0006X
UKCA approval	CML 22 UKEX 1267X

Release date: 2024-07-17 Date of issue: 2024-07-17 Filename: 400875_eng.pdf

Technical Data

CCoE approval	PESO A/P/HQ/KA/104/5579 (P420366)
CCC approval	2021312313000345
Conformity	
Degree of protection	EN 60529
General information	
Delivery quantity	63
Scope of delivery	Adapter Brief instructions (1 copy)
Supplementary information	EC-Type Examination Certificate, Statement of Conformity, Declaration of Conformity, Attestation of Conformity and instructions have to be observed where applicable. For information see www.pepperl-fuchs.com .