



Adapter

AD.M40.M32.BN.C.18.K01

- Adapter male thread metric to female thread metric
- Brass nickel-plated
- Thread M40
- Thread M32
- Seal chloroprene
- Ex db, Ex eb and Ex tb certified
- Suitable for operation in Zone 1, Zone 2, Zone 21 and Zone 22
- Packaging unit: 1 piece, kit with accessories



Assembly

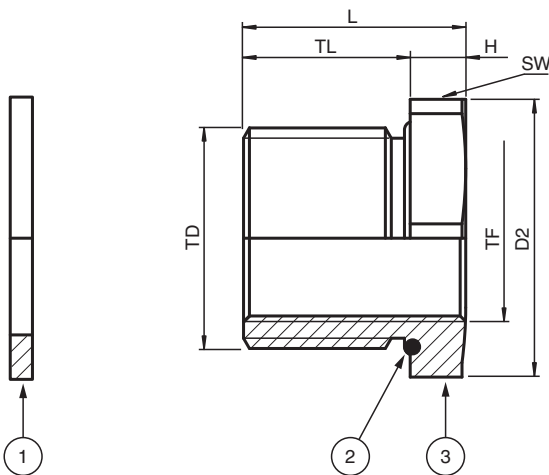
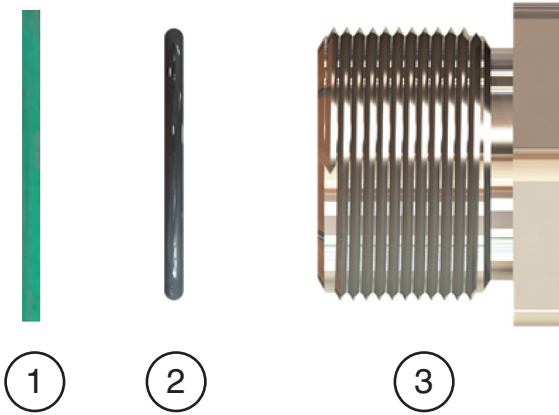

Assembly

Details see data table

Legend	
1	Washer gasket (accessory, metric threads only)
2	O-Ring (metric threads only)
3	Adapter
DI	Diameter internal hole
D2	Width across corners
H	Length outside enclosure
L	Total length
SW*	Width across flats
TD	Thread size
TF	Thread size female
TL	Thread length
TLF	Thread length female

Technical Data

Mechanical specifications		
Thread type		metric ISO pitch 1.5 mm
Thread size (TD)		M40
Thread type female		metric ISO pitch 1.5 mm
Thread size female (TF)		M32
Degree of protection		IP66 / IP68
Material		
Finish		inherent color silver
Washer gasket		aramid fibers bonded with NBR
Adapter		brass, nickel-plated
O-Ring		chloroprene
Mass		
Individual component		approx. 91 g
Packing unit		approx. 118 g
Dimensions		
Width across corners (D2)		50 mm
Length outside enclosure (H)		4 mm
Width across flats (SW1)		45 mm
Thread length (TL)		18 mm
Thread length female (TLF)		22 mm
Total length (L)		22 mm
Tightening torque		
Nut torque at enclosure (SW1)		9.5 Nm
Ambient conditions		
Ambient temperature		-40 ... 100 °C (-40 ... 212 °F) washer gasket -40 ... 80 °C (-40 ... 176 °F)
Data for application in connection with hazardous areas		
EU-type examination certificate		CESI 15 ATEX 029X
Marking		⊕ II 2 GD Ex db IIC Gb Ex eb IIC Gb Ex tb IIIC Db
International approvals		
IECEX approval		IECEX CES 15.0006X
UKCA approval		CML 22 UKEX 1267X

Release date: 2024-07-15 Date of issue: 2024-07-15 Filename: 400924_eng.pdf

Technical Data

CCoE approval	PESO A/P/HQ/KA/104/5579 (P420366)
CCC approval	2021312313000345
Conformity	
Degree of protection	EN 60529
General information	
Delivery quantity	1
Scope of delivery	Adapter locknut washer gasket Brief instructions
Supplementary information	EC-Type Examination Certificate, Statement of Conformity, Declaration of Conformity, Attestation of Conformity and instructions have to be observed where applicable. For information see www.pepperl-fuchs.com .