

Glass fiber optic

LLR 04-1,6-0,5-QW 1X4



- Chemical-resistant
- Optical face across the direction of fiber

Glass fiber optic - diffuse with metal silicone covering

Dimensions

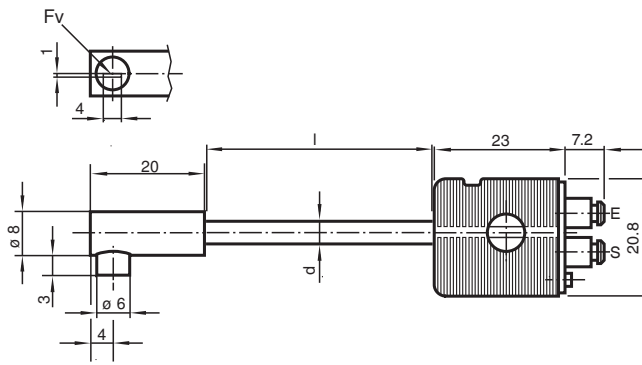

Technical Data

General specifications

Fiber optic length	l	500 mm
Fiber optic diameter	d	7.3 mm
Adapter form		04
End piece		Thread / cylindrical right angle
Bending radius		min. 25 mm
Fiber bundle diameter		1 x 2.15 mm / optical face: 1 x 3.6 mm ²
Fiber configuration	Fv	statistical mixed
Angle of divergence		approx. 69 °

Approvals and certificates

Approvals		CE
-----------	--	----

Ambient conditions

Ambient temperature		-20 ... 85 °C (-4 ... 185 °F) [Adapter] -40 ... 180 °C (-40 ... 356 °F) [End head and Covering]
Storage temperature		-20 ... 85 °C (-4 ... 185 °F)

Mechanical specifications

Degree of protection		IP65
----------------------	--	------

Release date: 2021-07-05 Date of issue: 2021-07-05 Filename: 415675_eng.pdf

Technical Data

Material	
Optical face	glass
Sheathing	Metal-silicon
Core	Glass fiber
End piece	Stainless steel 1.4305 / AISI 303
Adapter	PVC
Extraction force	at probe at 20°C: 120 N
Fiber optic amplifiers	
Device series	MLV41-LL

Application

Attention:

Fiber optics must not be twisted or kinked. Excessive tensile loads will lead to destruction. Contact with petrol or organic solvents must be prevented.

